

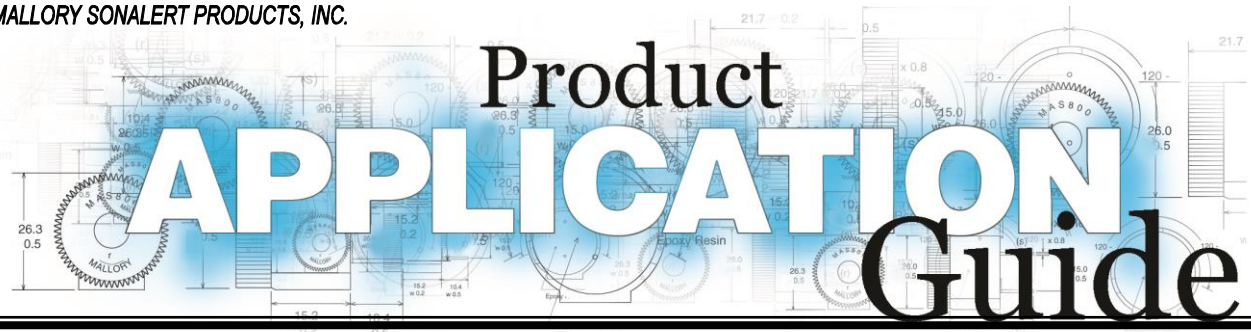

MALLORY SONALERT PRODUCTS, INC.



# Product APPLICATION Guide

## Product Application Guide- Transducers- External Drive- Electromagnetic

### Part Numbering System Transducer Series (PB)

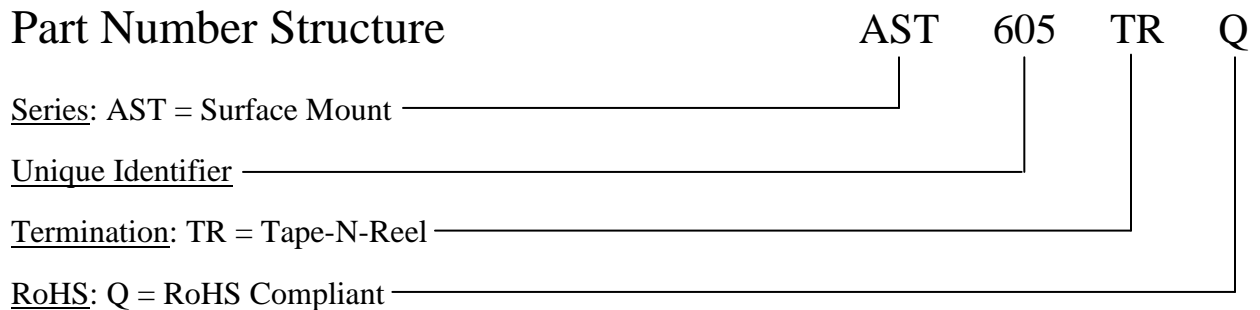
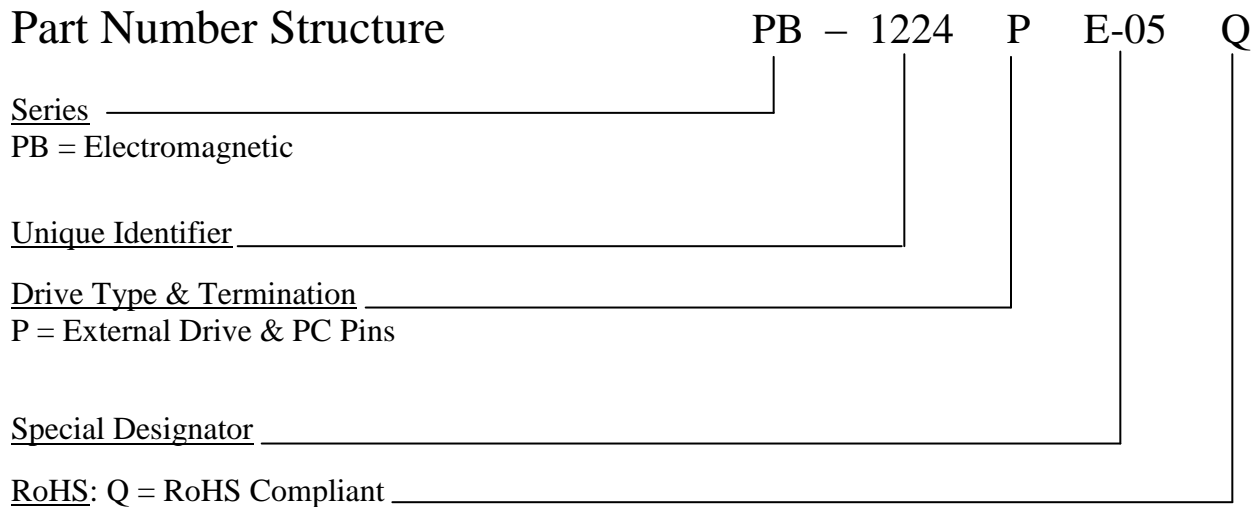

## Decibel Sound Level Scale

The decibel sound level scale is an arbitrary scale that ranges from 0 dB (threshold of hearing) to 130 dB (threshold of pain). The chart below shows where some common sounds fall on this dB scale. Audible alarms are available that have sound levels as soft as 55 dB at 2 feet and as loud as 110 dB at 2 feet.

### Reference Sound Levels

(as if you were standing 2 feet from the sound source)

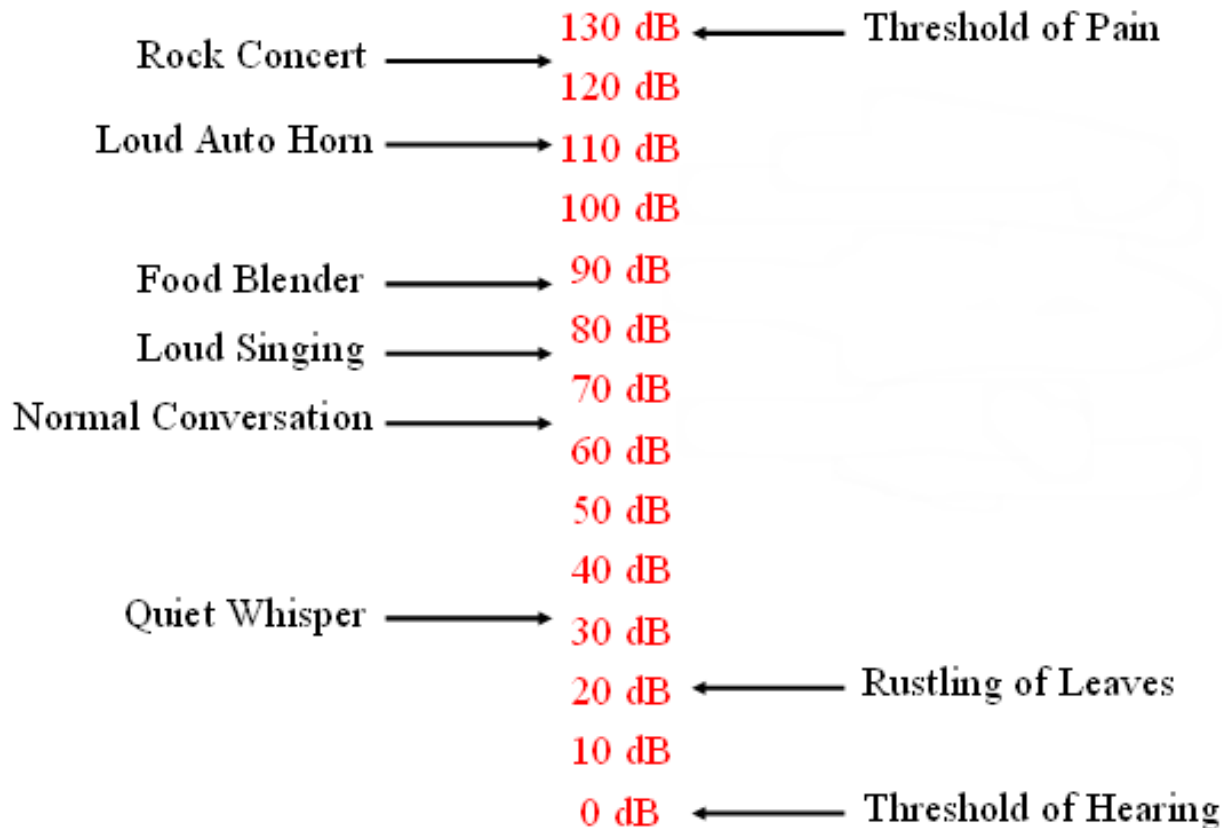

## Fundamental Frequency & Harmonics

Below is a frequency scan of a piezoelectric audible alarm that has a resonant frequency of 2,800 Hz. As you can see, there is a strong frequency peak at 2.8 kHz and several smaller frequency peaks that follow called harmonic frequencies. The table below the chart shows that the size of the harmonic frequencies are significantly smaller than the fundamental frequency for this particular alarm unit. Because this alarm has a large fundamental frequency and much smaller harmonic frequencies, the sound quality of this part will be very good. When this alarm is activated, the listener will hear one clear frequency (also called sound pitch) from the alarm. Other electronic alarm technologies such as electro-magnetic or electro-mechanical type alarms often have much larger harmonic frequency components resulting in less clear tone.

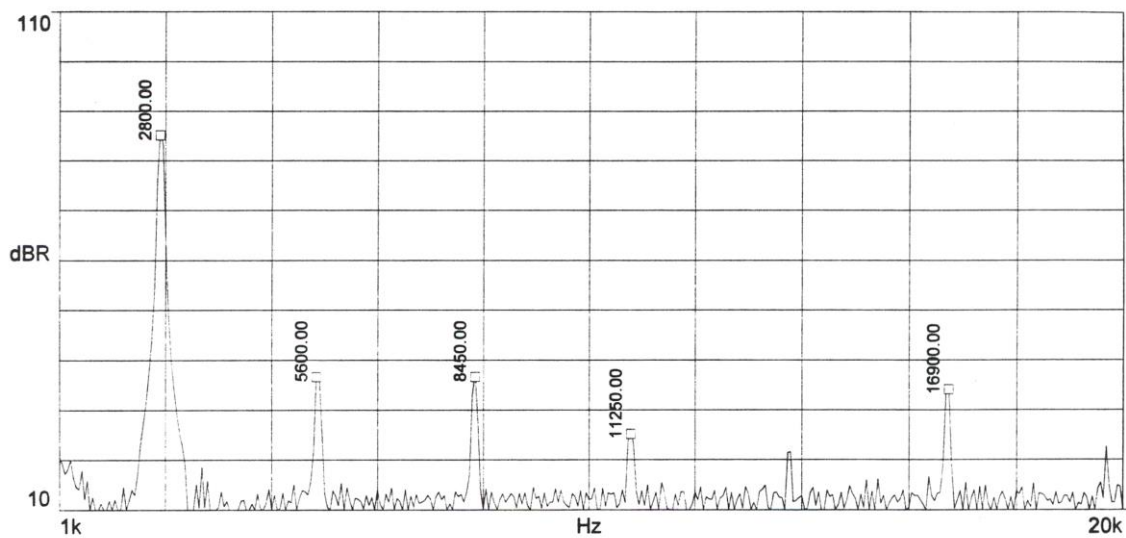

	Frequency	dB	% dB of Fundamental
Fundamental:	2.800 KHz	86.1	100.0%
2nd Harmonic:	5.600 KHz	37.6	43.7%
3rd Harmonic:	8.450 KHz	37.6	43.7%
4th Harmonic:	11.250 KHz	26.1	30.3%

## Driving Electromagnetic Transducers

Electromagnetic transducers utilize electromagnets that enable these devices to produce low sound frequencies in small package sizes. The penalty is that these devices require more current to work, have limited voltage ratings, and the electromagnetic coil can create voltage spikes; which, makes the circuit designer's job more challenging.

The following two circuits are self-contained in that the circuit produces the sine wave type signal required by the buzzer. The circuit challenge is to set the value of the capacitors, resistors, and/or inductors to produce the rated buzzer oscillating frequency.

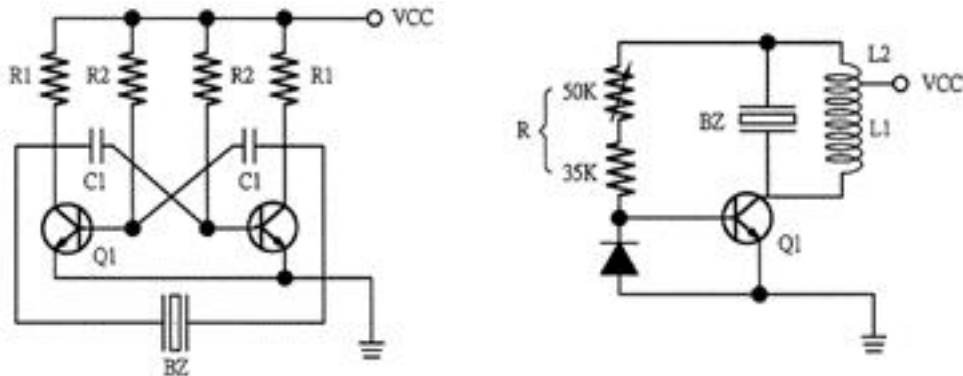

The following three circuits provide a means to drive the electromagnetic transducer buzzer, but they require an input signal to turn the drive circuitry off and on at the appropriate rated buzzer frequency. Care must be taken not to over-voltage the buzzer.

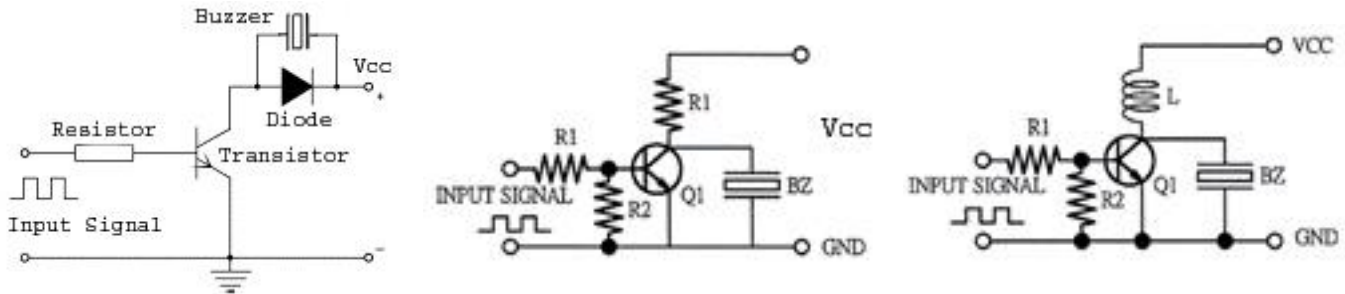

The input signal to the previous three drive circuits can come from a microcontroller output or from a logic circuit similar to the following:

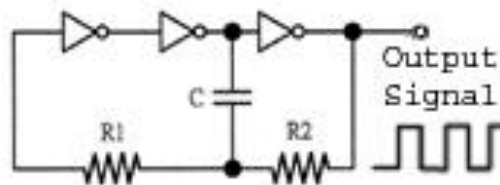

The capacitor and resistors values need to be set to provide a signal at the appropriate rated buzzer frequency. For example, if the electromagnetic buzzer is rated at 2.3 KHz, then the output signal's frequency from the microcontroller or from the above circuit needs to be at 2.3 KHz.

The inductors needed for some of the above circuits may need to handle large current values and may need to have large inductance ratings. The inductance ratings needed can range from 1 milli-Henry (1000 uH) to 100 milli-Henry (100000 uH).

One source for these types of inductors is:

Bourns- JW Miller Inductors ([www.bourns.com](http://www.bourns.com))

Product Series: JW Miller 5900 Series High Current Chokes  
([http://www.bourns.com/pdfs/5900\\_series.pdf](http://www.bourns.com/pdfs/5900_series.pdf))

## - All P/N's

Part Number	Tube Count	Reel Count
ASI301Q	35	
ASI301TRQ		250
ASI401Q	35	
ASI401TRQ		250
AST100Q	25	
AST100TRQ		500
AST1109MLTRQ		1000
AST1240MLTRQ		1000
AST1440MATRQ		600
AST1575BMATRQ		300
AST1628MATRQ		800
AST1750MATRQ		400
AST200Q	48	
AST200TRQ		1000
AST501Q	35	
AST501TRQ		450
AST605Q	35	
AST605TRQ		300

Part Number	Tube Count	Reel Count
AST612Q	35	
AST612TRQ		450
AST7525MATRQ		1000
PB-1220PQ	40	
PB-1221PQ	40	
PB-1224PE-05Q	40	
PB-12N23P-01Q	40	
PB-12N23P-03Q	40	
PB-12N23P-05Q	40	
PB-12N23P-12Q	40	