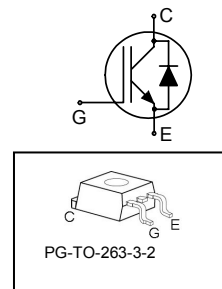


## High Speed IGBT in NPT-technology

- 30% lower  $E_{off}$  compared to previous generation
- Short circuit withstand time – 10  $\mu$ s
- Designed for operation above 30 kHz
- NPT-Technology for 600V applications offers:
  - parallel switching capability
  - moderate  $E_{off}$  increase with temperature
  - very tight parameter distribution
- High ruggedness, temperature stable behaviour
- Pb-free lead plating; RoHS compliant
- Qualified according to JEDEC<sup>1</sup> for target applications
- Complete product spectrum and PSpice Models : <http://www.infineon.com/igbt/>



Type	$V_{CE}$	$I_C$	$E_{off}$	$T_j$	Marking	Package
SKB06N60HS	600V	6A	80 $\mu$ J	150°C	K06N60HS	PG-TO-263-3-2

### Maximum Ratings

Parameter	Symbol	Value	Unit
Collector-emitter voltage	$V_{CE}$	600	V
DC collector current	$I_C$	12	A
$T_C = 25^\circ\text{C}$		6	
$T_C = 100^\circ\text{C}$		6	
Pulsed collector current, $t_p$ limited by $T_{jmax}$	$I_{Cpuls}$	24	
Turn off safe operating area	-	24	
$V_{CE} \leq 600\text{V}, T_j \leq 150^\circ\text{C}$			
Diode forward current	$I_F$	12	
$T_C = 25^\circ\text{C}$		6	
$T_C = 100^\circ\text{C}$		6	
Diode pulsed current, $t_p$ limited by $T_{jmax}$	$I_{Fpuls}$	24	
Gate-emitter voltage static	$V_{GE}$	$\pm 20$	V
transient ( $t_p < 1\mu\text{s}, D < 0.05$ )		$\pm 30$	
Short circuit withstand time <sup>2)</sup>	$t_{SC}$	10	$\mu\text{s}$
$V_{GE} = 15\text{V}, V_{CC} \leq 400\text{V}, T_j \leq 150^\circ\text{C}$			
Power dissipation	$P_{tot}$	68	W
$T_C = 25^\circ\text{C}$			
Operating junction and storage temperature	$T_j, T_{stg}$	-55...+150	$^\circ\text{C}$
Time limited operating junction temperature for $t < 150\text{h}$	$T_{j(tl)}$	175	
Soldering temperature (reflow soldering, MSL1)	-	245	

<sup>1</sup> J-STD-020 and JESD-022

<sup>2)</sup> Allowed number of short circuits: <1000; time between short circuits: >1s.

**Thermal Resistance**

Parameter	Symbol	Conditions	Max. Value	Unit
<b>Characteristic</b>				
IGBT thermal resistance, junction – case	$R_{thJC}$		1.85	K/W
Diode thermal resistance, junction – case	$R_{thJCD}$		4.5	
Thermal resistance, junction – ambient	$R_{thJA}$		62	
SMD version, device on PCB <sup>1)</sup>	$R_{thJA}$		40	

**Electrical Characteristic, at  $T_j = 25\text{ °C}$ , unless otherwise specified**

Parameter	Symbol	Conditions	Value			Unit
			min.	Typ.	max.	
<b>Static Characteristic</b>						
Collector-emitter breakdown voltage	$V_{(BR)CES}$	$V_{GE}=0V, I_C=500\mu A$	600	-	-	V
Collector-emitter saturation voltage	$V_{CE(sat)}$	$V_{GE} = 15V, I_C=6A$ $T_j=25\text{ °C}$ $T_j=150\text{ °C}$		2.8 3.5	3.15 4.00	
Diode forward voltage	$V_F$	$V_{GE}=0V, I_F=6A$ $T_j=25\text{ °C}$ $T_j=150\text{ °C}$	-	1.5 1.55	2.05 2.05	
Gate-emitter threshold voltage	$V_{GE(th)}$	$I_C=200\mu A, V_{CE}=V_{GE}$	3	4	5	
Zero gate voltage collector current	$I_{CES}$	$V_{CE}=600V, V_{GE}=0V$ $T_j=25\text{ °C}$ $T_j=150\text{ °C}$	- -	- -	40 2000	$\mu A$
Gate-emitter leakage current	$I_{GES}$	$V_{CE}=0V, V_{GE}=20V$	-	-	100	
Transconductance	$g_{fs}$	$V_{CE}=20V, I_C=6A$	-	4		S

**Dynamic Characteristic**

Input capacitance	$C_{iss}$	$V_{CE}=25V,$ $V_{GE}=0V,$ $f=1MHz$	-	350		pF
Output capacitance	$C_{oss}$		-	50		
Reverse transfer capacitance	$C_{riss}$		-	23		
Gate charge	$Q_{Gate}$	$V_{CC}=480V, I_C=6A$ $V_{GE}=15V$	-	33		nC
Internal emitter inductance measured 5mm (0.197 in.) from case	$L_E$		-	7		nH
Short circuit collector current <sup>2)</sup>	$I_{C(SC)}$	$V_{GE}=15V, t_{SC}\leq 10\mu s$ $V_{CC}\leq 400V,$ $T_j\leq 150\text{ °C}$	-	48		A

<sup>1)</sup> Device on 50mm\*50mm\*1.5mm epoxy PCB FR4 with 6cm<sup>2</sup> (one layer, 70 $\mu$ m thick) copper area for collector connection. PCB is vertical without blown air.

<sup>2)</sup> Allowed number of short circuits: <1000; time between short circuits: >1s.

**Switching Characteristic, Inductive Load, at  $T_j=25\text{ }^\circ\text{C}$** 

Parameter	Symbol	Conditions	Value			Unit
			min.	typ.	max.	
<b>IGBT Characteristic</b>						
Turn-on delay time	$t_{d(on)}$	$T_j=25\text{ }^\circ\text{C}$ , $V_{CC}=400\text{V}$ , $I_C=6\text{A}$ , $V_{GE}=0/15\text{V}$ , $R_G=50\text{ }\Omega$ $L_{\sigma}^{2)}=60\text{nH}$ , $C_{\sigma}^{2)}=40\text{pF}$ Energy losses include "tail" and diode reverse recovery.	-	11		ns
Rise time	$t_r$		-	11		
Turn-off delay time	$t_{d(off)}$		-	196		
Fall time	$t_f$		-	41		mJ
Turn-on energy	$E_{on}$		-	0.10		
Turn-off energy	$E_{off}$		-	0.09		
Total switching energy	$E_{ts}$		-	0.19		

**Anti-Parallel Diode Characteristic**

Diode reverse recovery time	$t_{rr}$	$T_j=25\text{ }^\circ\text{C}$ , $V_R=400\text{V}$ , $I_F=6\text{A}$ , $di_F/dt=626\text{A}/\mu\text{s}$	-	100		ns
	$t_S$		-	24		
	$t_F$		-	76		
Diode reverse recovery charge	$Q_{rr}$		-	220		nC
Diode peak reverse recovery current	$I_{rrm}$		-	7		A
Diode peak rate of fall of reverse recovery current during $t_b$	$di_{rr}/dt$	-	315		A/ $\mu\text{s}$	

**Switching Characteristic, Inductive Load, at  $T_j=150\text{ }^\circ\text{C}$** 

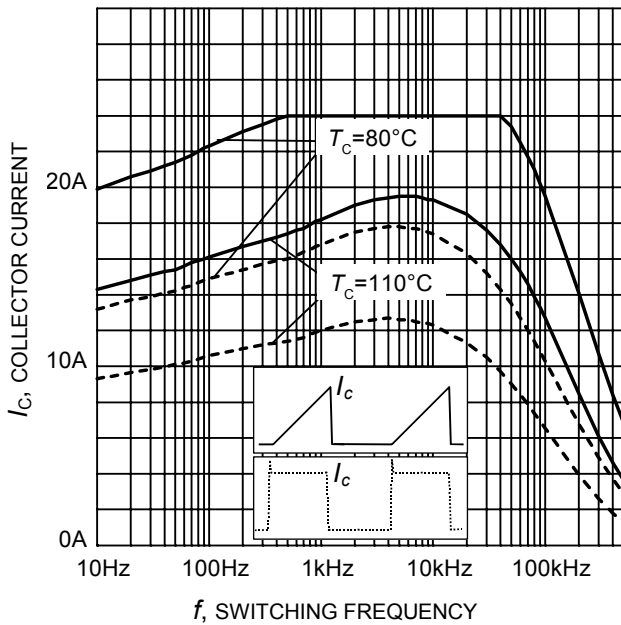
Parameter	Symbol	Conditions	Value			Unit
			min.	typ.	max.	
<b>IGBT Characteristic</b>						
Turn-on delay time	$t_{d(on)}$	$T_j=150\text{ }^\circ\text{C}$ $V_{CC}=400\text{V}$ , $I_C=6\text{A}$ , $V_{GE}=0/15\text{V}$ , $R_G=8\text{ }\Omega$ $L_{\sigma}^{1)}=60\text{nH}$ , $C_{\sigma}^{1)}=40\text{pF}$ Energy losses include "tail" and diode reverse recovery.	-	8		ns
Rise time	$t_r$		-	3		
Turn-off delay time	$t_{d(off)}$		-	63		
Fall time	$t_f$		-	59		mJ
Turn-on energy	$E_{on}$		-	0.11		
Turn-off energy	$E_{off}$		-	0.08		
Total switching energy	$E_{ts}$		-	0.19		
Turn-on delay time	$t_{d(on)}$	$T_j=150\text{ }^\circ\text{C}$ $V_{CC}=400\text{V}$ , $I_C=6\text{A}$ , $V_{GE}=0/15\text{V}$ , $R_G=50\text{ }\Omega$ $L_{\sigma}^{1)}=60\text{nH}$ , $C_{\sigma}^{1)}=40\text{pF}$ Energy losses include "tail" and diode reverse recovery.	-	10		ns
Rise time	$t_r$		-	13		
Turn-off delay time	$t_{d(off)}$		-	216		
Fall time	$t_f$		-	29		mJ
Turn-on energy	$E_{on}$		-	0.15		
Turn-off energy	$E_{off}$		-	0.12		
Total switching energy	$E_{ts}$		-	0.27		

2) Leakage inductance  $L_{\sigma}$  and Stray capacity  $C_{\sigma}$  due to test circuit in Figure E.

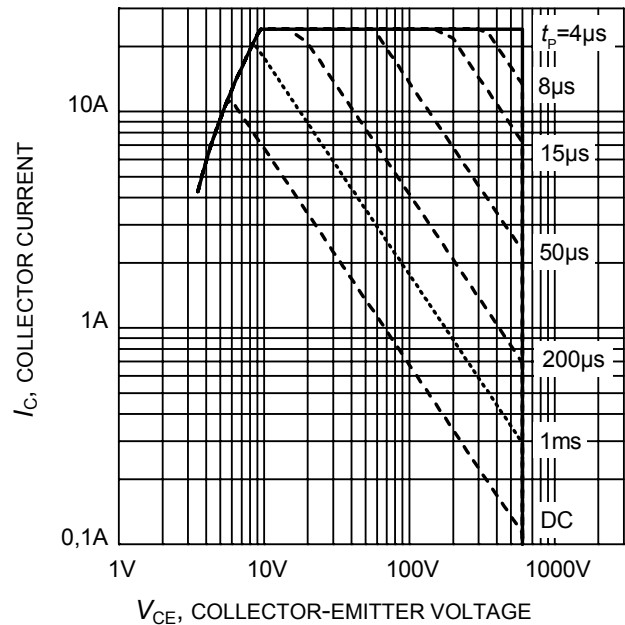
1) Leakage inductance  $L_{\sigma}$  and Stray capacity  $C_{\sigma}$  due to test circuit in Figure E.

**Anti-Parallel Diode Characteristic**

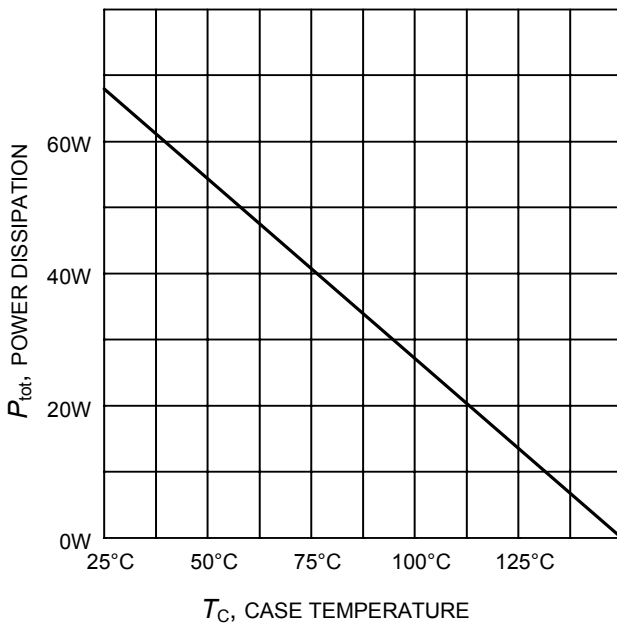
Diode reverse recovery time	$t_{rr}$	$T_j=150^{\circ}\text{C}$ $V_R=400\text{V}, I_F=6\text{A},$ $di_F/dt=673\text{A}/\mu\text{s}$	-	150		ns
	$t_S$		-	27		
	$t_F$		-	123		
Diode reverse recovery charge	$Q_{rr}$		-	500		nC
Diode peak reverse recovery current	$I_{rrm}$	-	8.8		A	
Diode peak rate of fall of reverse recovery current during $t_b$	$di_{rr}/dt$	-	280		A/ $\mu\text{s}$	



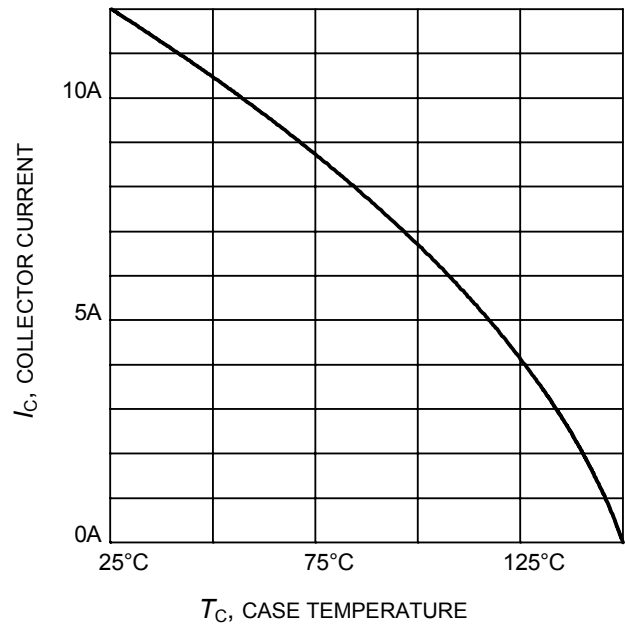
**Figure 1. Collector current as a function of switching frequency**  
 ( $T_j \leq 150^\circ\text{C}$ ,  $D = 0.5$ ,  $V_{CE} = 400\text{V}$ ,  
 $V_{GE} = 0/+15\text{V}$ ,  $R_G = 50\Omega$ )



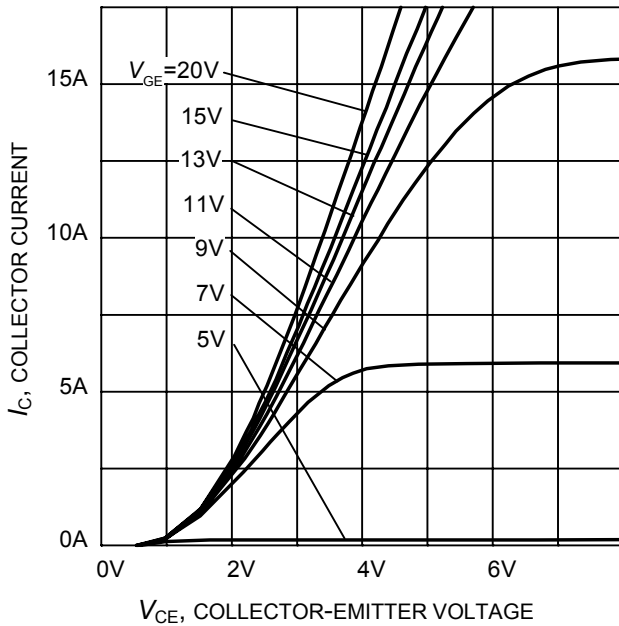
**Figure 2. Safe operating area**  
 ( $D = 0$ ,  $T_C = 25^\circ\text{C}$ ,  
 $T_j \leq 150^\circ\text{C}$ ;  $V_{GE} = 15\text{V}$ )



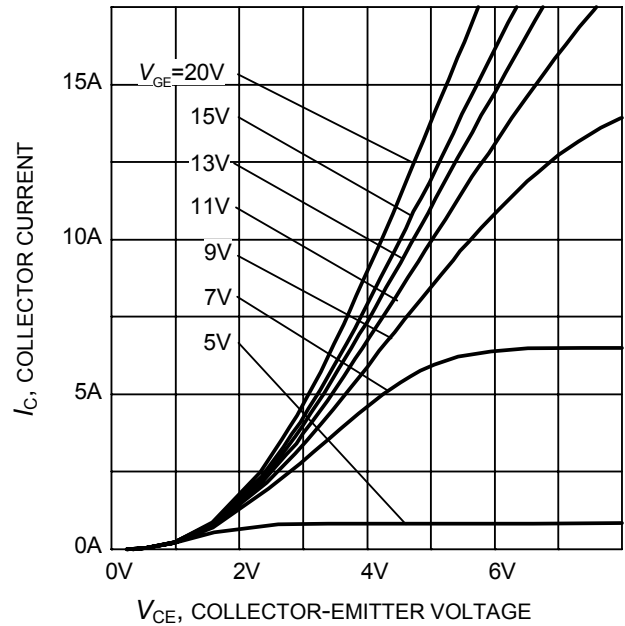
**Figure 3. Power dissipation as a function of case temperature**  
 ( $T_j \leq 150^\circ\text{C}$ )



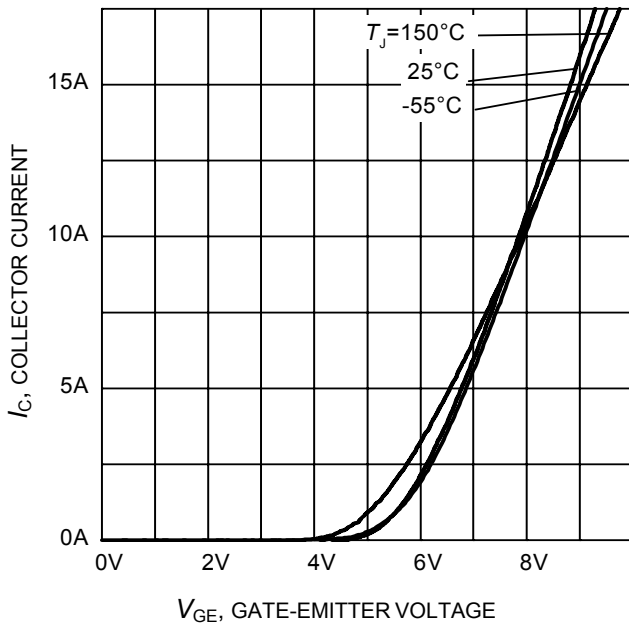
**Figure 4. Collector current as a function of case temperature**  
 ( $V_{GE} \leq 15\text{V}$ ,  $T_j \leq 150^\circ\text{C}$ )



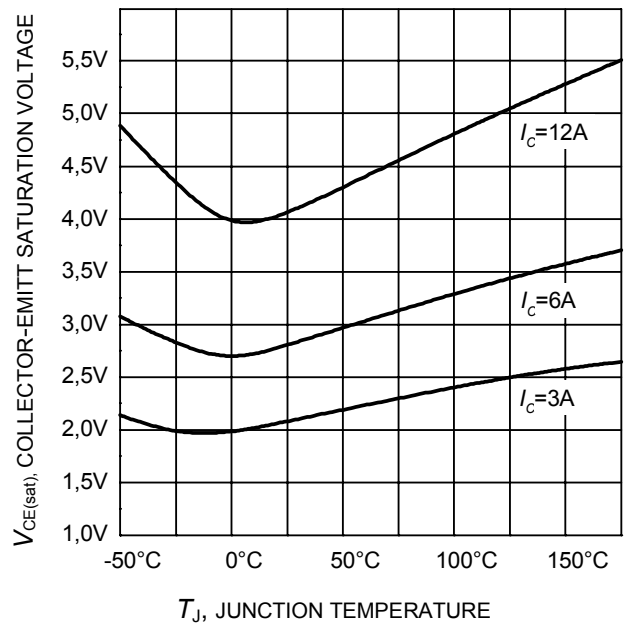
**Figure 5. Typical output characteristic**  
( $T_j = 25^\circ\text{C}$ )



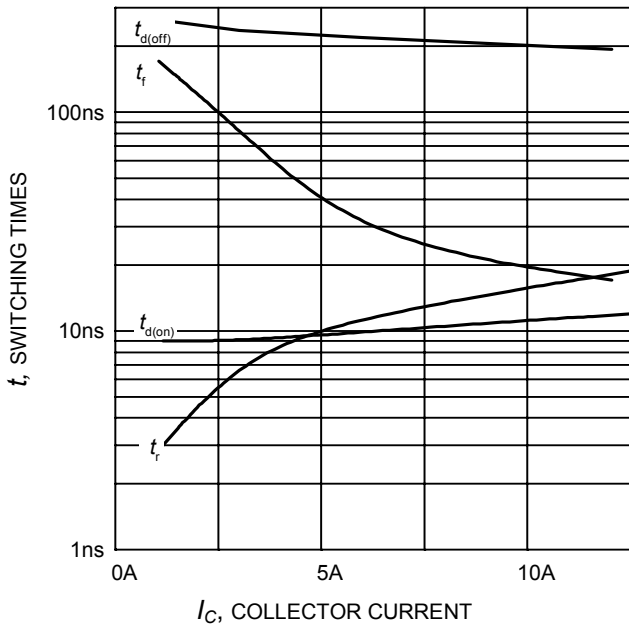
**Figure 6. Typical output characteristic**  
( $T_j = 150^\circ\text{C}$ )



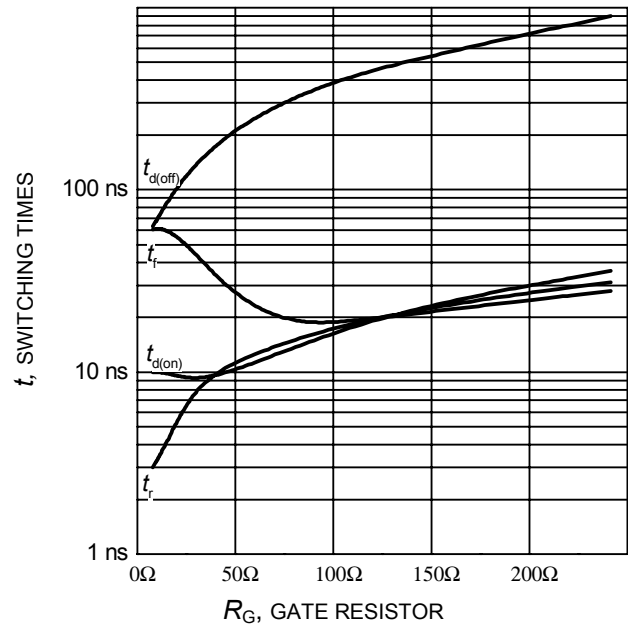
**Figure 7. Typical transfer characteristic**  
( $V_{CE} = 10\text{V}$ )



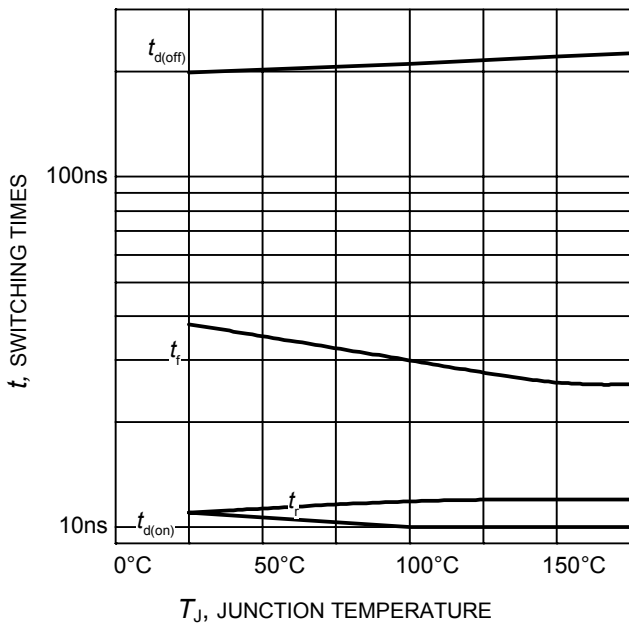
**Figure 8. Typical collector-emitter saturation voltage as a function of junction temperature**  
( $V_{GE} = 15\text{V}$ )



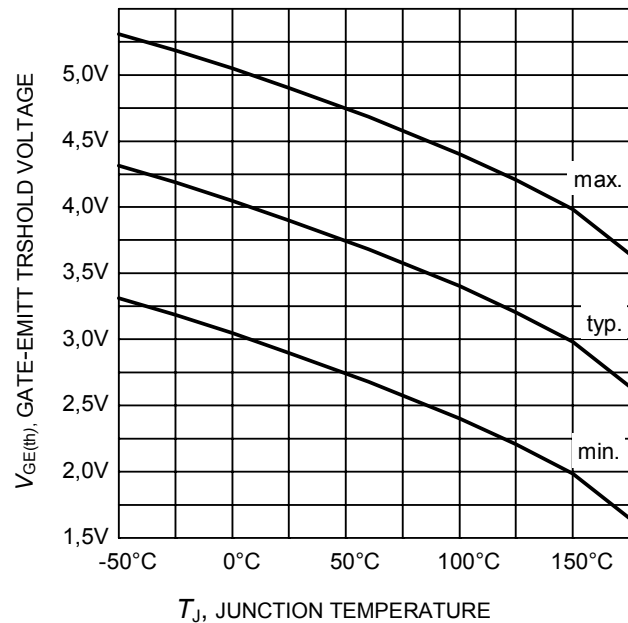
**Figure 9. Typical switching times as a function of collector current**  
 (inductive load,  $T_J=150^{\circ}\text{C}$ ,  $V_{CE}=400\text{V}$ ,  $V_{GE}=0/15\text{V}$ ,  $R_G=50\Omega$ , Dynamic test circuit in Figure E)



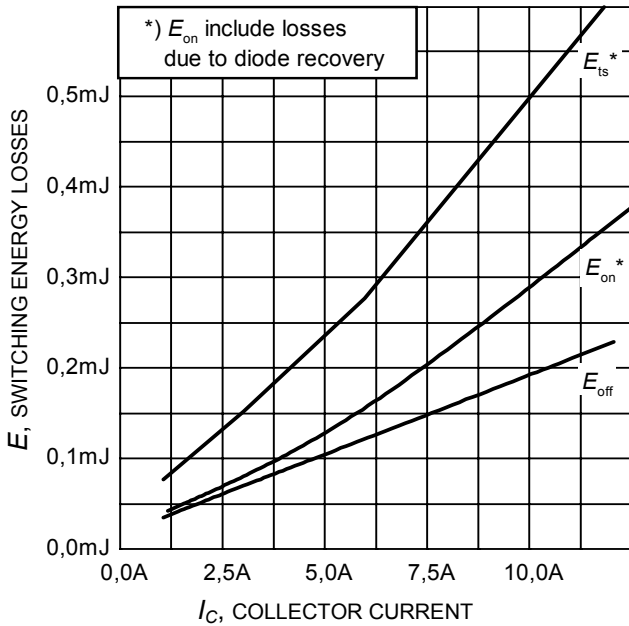
**Figure 10. Typical switching times as a function of gate resistor**  
 (inductive load,  $T_J=150^{\circ}\text{C}$ ,  $V_{CE}=400\text{V}$ ,  $V_{GE}=0/15\text{V}$ ,  $I_C=6\text{A}$ , Dynamic test circuit in Figure E)



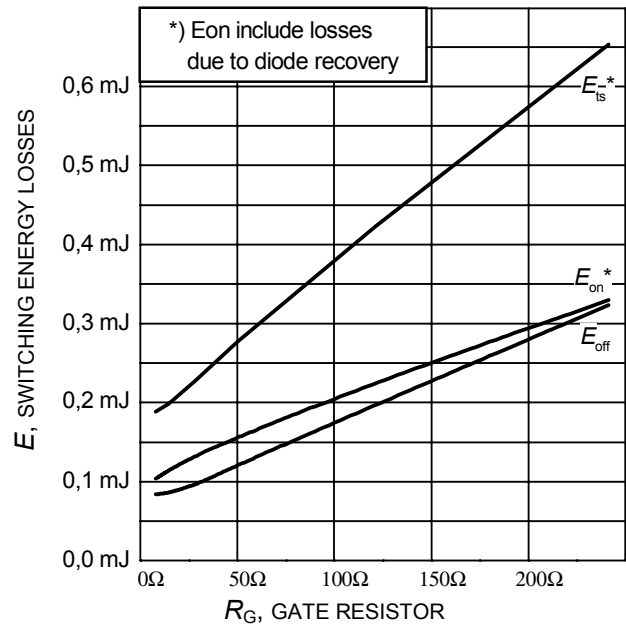
**Figure 11. Typical switching times as a function of junction temperature**  
 (inductive load,  $V_{CE}=400\text{V}$ ,  $V_{GE}=0/15\text{V}$ ,  $I_C=6\text{A}$ ,  $R_G=50\Omega$ , Dynamic test circuit in Figure E)



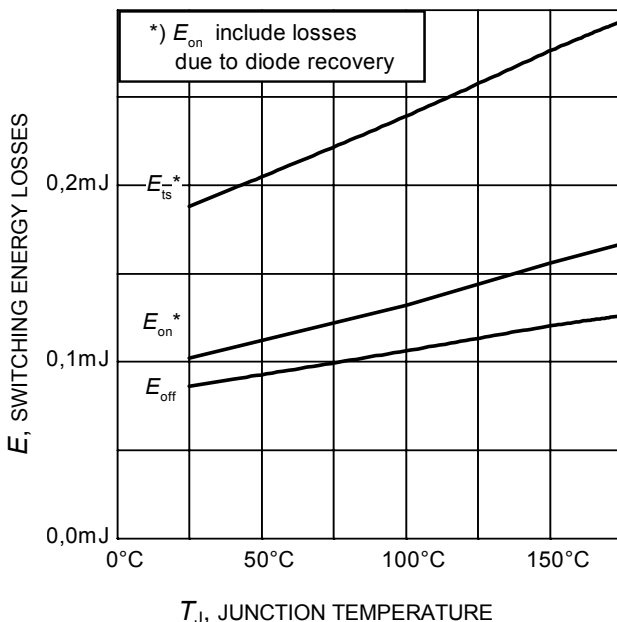
**Figure 12. Gate-emitter threshold voltage as a function of junction temperature**  
 ( $I_C = 0.5\text{mA}$ )



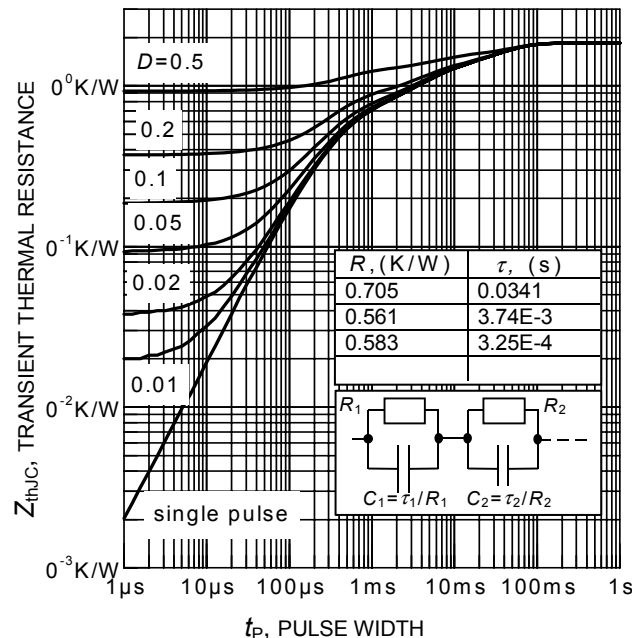
**Figure 13. Typical switching energy losses as a function of collector current**  
 (inductive load,  $T_J=150^\circ\text{C}$ ,  $V_{CE}=400\text{V}$ ,  $V_{GE}=0/15\text{V}$ ,  $R_G=50\Omega$ , Dynamic test circuit in Figure E)



**Figure 14. Typical switching energy losses as a function of gate resistor**  
 (inductive load,  $T_J=150^\circ\text{C}$ ,  $V_{CE}=400\text{V}$ ,  $V_{GE}=0/15\text{V}$ ,  $I_C=6\text{A}$ , Dynamic test circuit in Figure E)

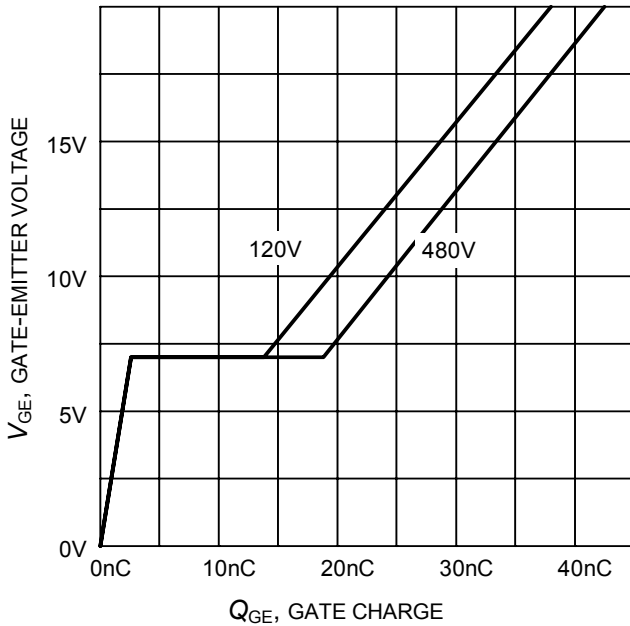


**Figure 15. Typical switching energy losses as a function of junction temperature**  
 (inductive load,  $V_{CE}=400\text{V}$ ,  $V_{GE}=0/15\text{V}$ ,  $I_C=6\text{A}$ ,  $R_G=50\Omega$ , Dynamic test circuit in Figure E)

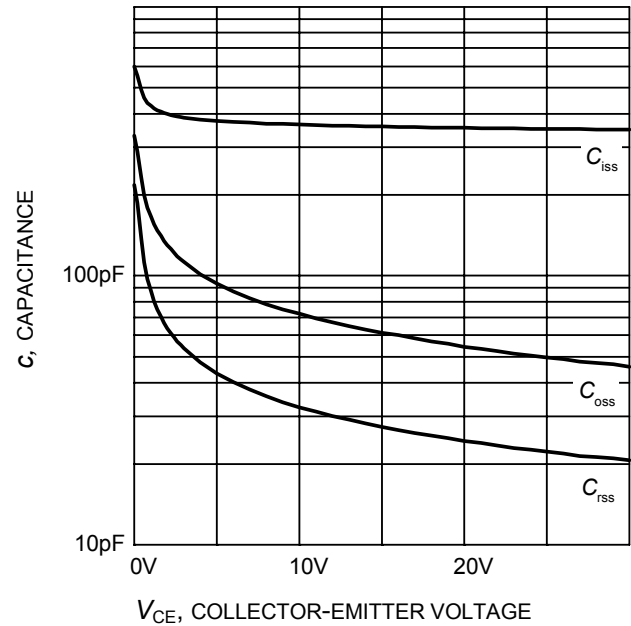


**Figure 16. IGBT transient thermal resistance**  
 ( $D = t_p / T$ )

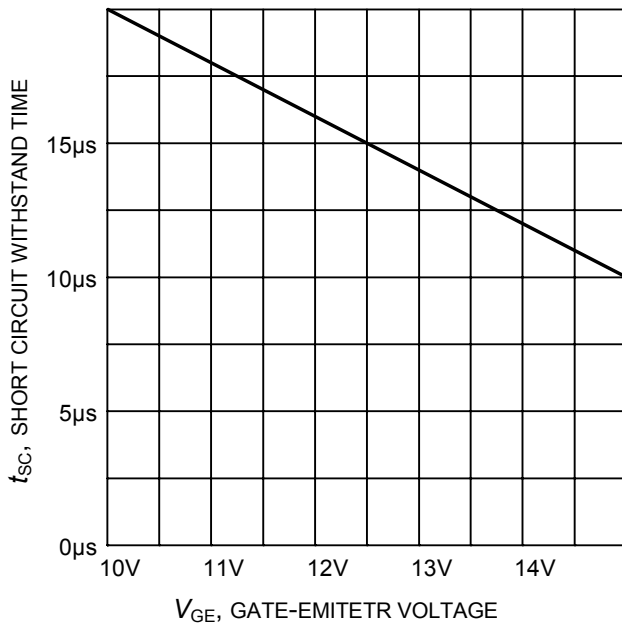




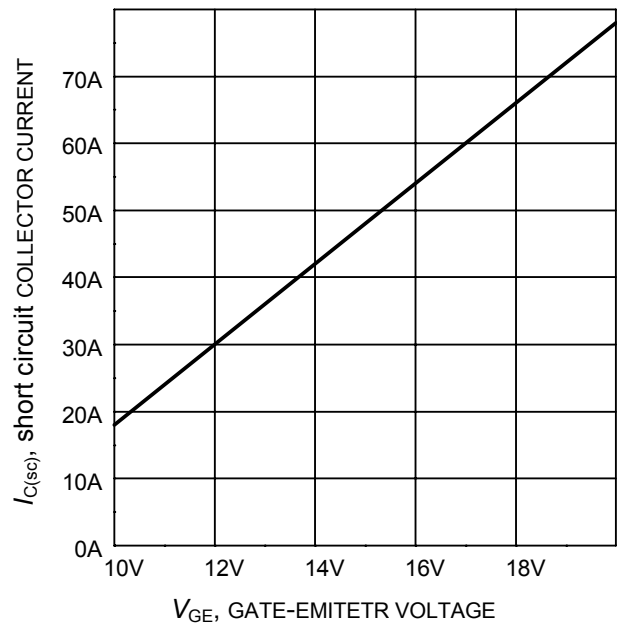
**Figure 17. Typical gate charge**  
( $I_C=6\text{ A}$ )



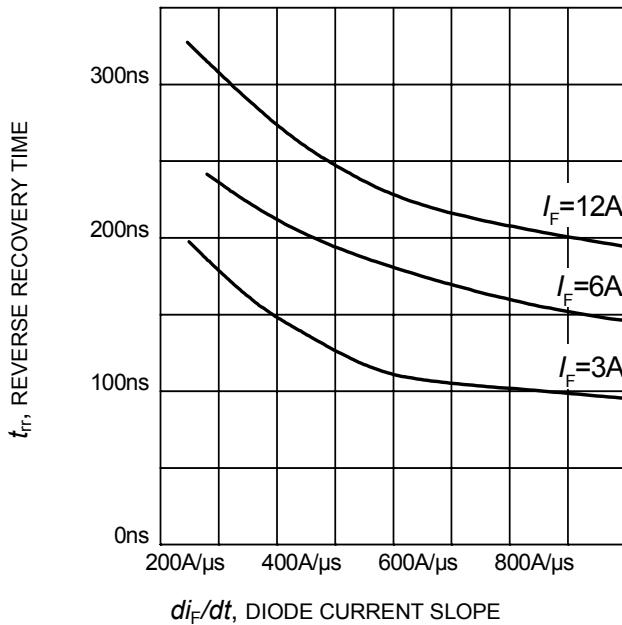
**Figure 18. Typical capacitance as a function of collector-emitter voltage**  
( $V_{GE}=0\text{V}$ ,  $f = 1\text{ MHz}$ )



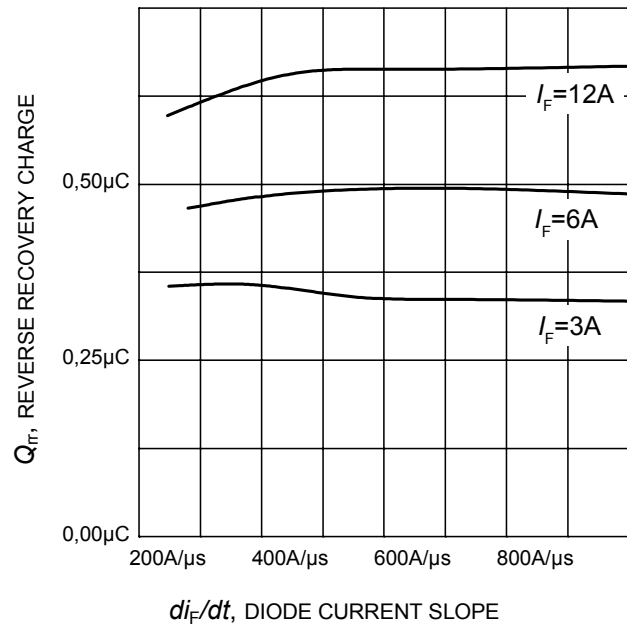
**Figure 19. Short circuit withstand time as a function of gate-emitter voltage**  
( $V_{CE}=600\text{V}$ , start at  $T_J=25^\circ\text{C}$ )



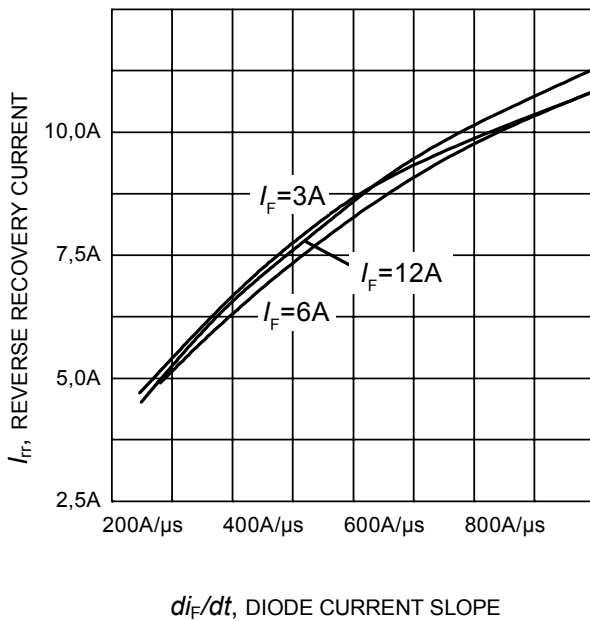
**Figure 20. Typical short circuit collector current as a function of gate-emitter voltage**  
( $V_{CE} \leq 400\text{V}$ ,  $T_J \leq 150^\circ\text{C}$ )



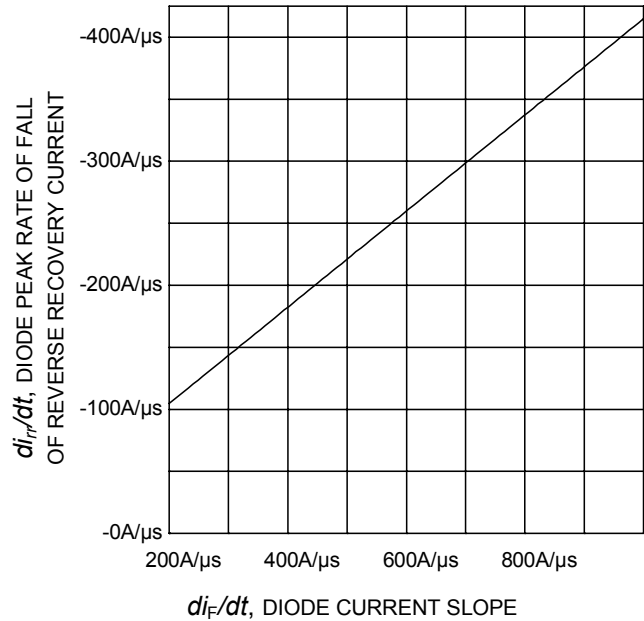
**Figure 21. Typical reverse recovery time as a function of diode current slope**  
 ( $V_R=400V$ ,  $T_J=150^\circ C$ ,  
 Dynamic test circuit in Figure E)



**Figure 22. Typical reverse recovery charge as a function of diode current slope**  
 ( $V_R=400V$ ,  $T_J=150^\circ C$ ,  
 Dynamic test circuit in Figure E)



**Figure 23. Typical reverse recovery current as a function of diode current slope**  
 ( $V_R=400V$ ,  $T_J=150^\circ C$ ,  
 Dynamic test circuit in Figure E)



**Figure 24. Typical diode peak rate of fall of reverse recovery current as a function of diode current slope**  
 ( $V_R=400V$ ,  $T_J=150^\circ C$ ,  
 Dynamic test circuit in Figure E)

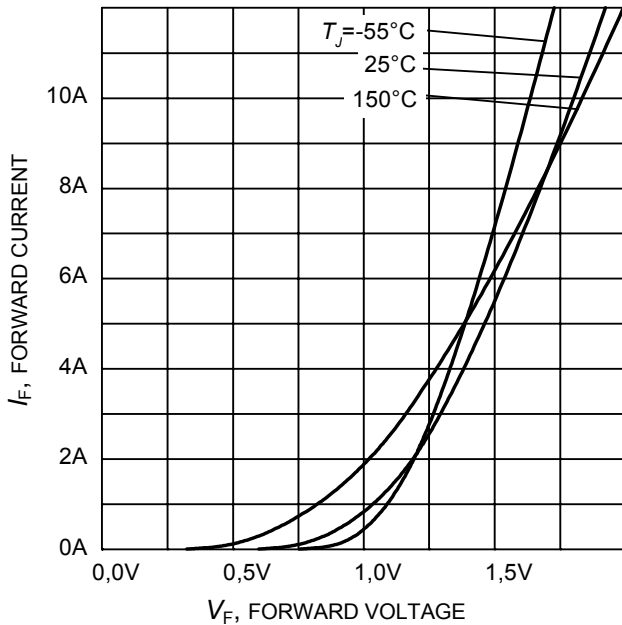


Figure 25. Typical diode forward current as a function of forward voltage

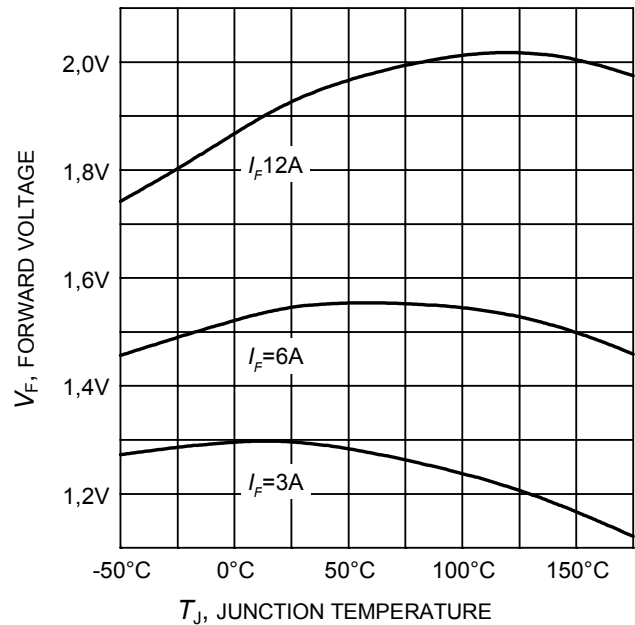


Figure 26. Typical diode forward voltage as a function of junction temperature

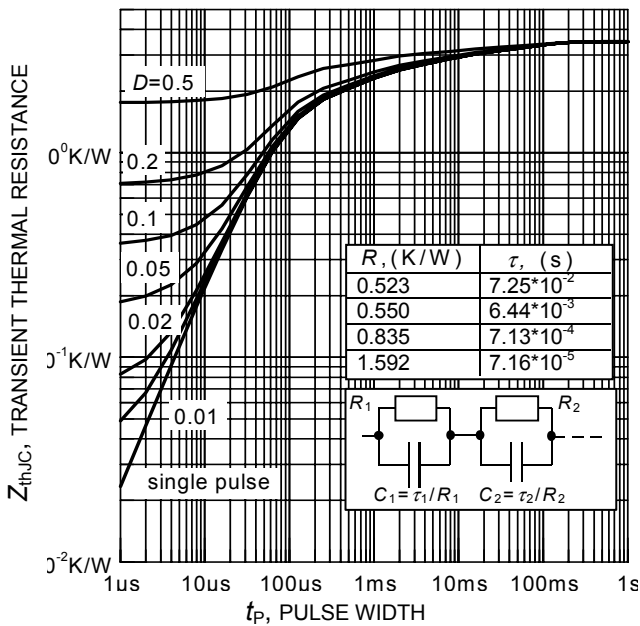
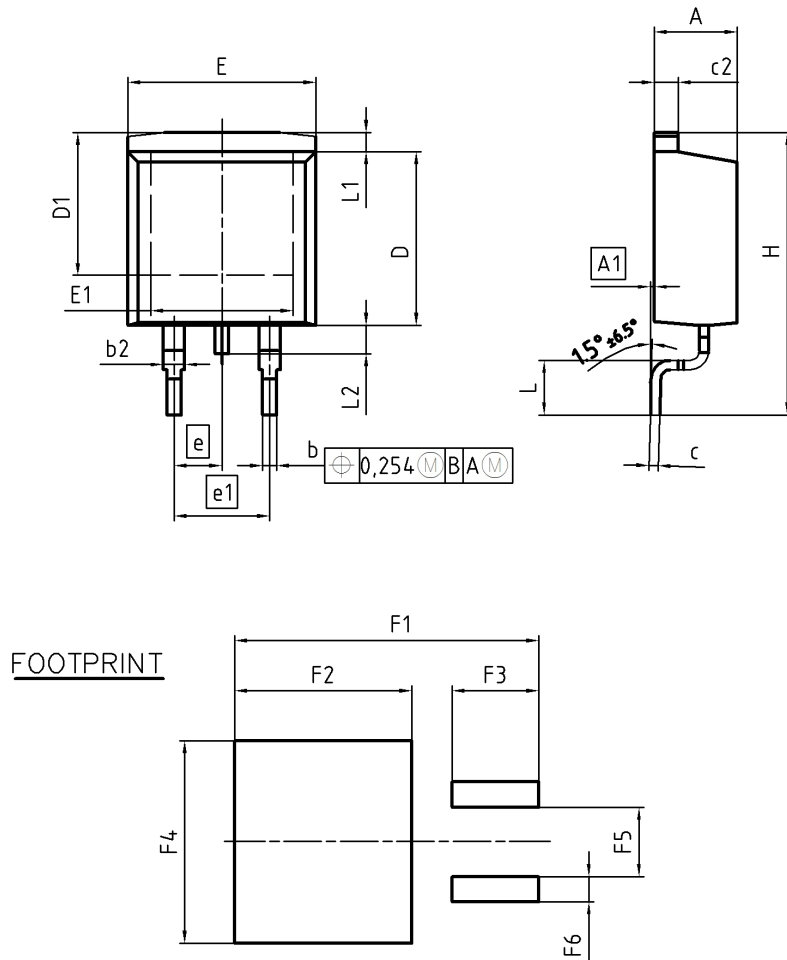


Figure 27. Diode transient thermal impedance as a function of pulse width ( $D=t_p/T$ )

PG-TO-263-3-2



DIM	MILLIMETERS		INCHES	
	MIN	MAX	MIN	MAX
A	4.30	4.57	0.169	0.180
A1	0.00	0.25	0.000	0.010
b	0.65	0.85	0.026	0.033
b2	0.95	1.15	0.037	0.045
c	0.33	0.65	0.013	0.026
c2	1.17	1.40	0.046	0.055
D	8.51	9.45	0.335	0.372
D1	7.10	7.90	0.280	0.311
E	9.80	10.31	0.386	0.406
E1	6.50	8.60	0.256	0.339
e	2.54		0.100	
e1	5.08		0.200	
N	2		2	
H	14.61	15.88	0.575	0.625
L	2.29	3.00	0.090	0.118
L1	0.70	1.60	0.028	0.063
L2	1.00	1.78	0.039	0.070
F1	16.05	16.25	0.632	0.640
F2	9.30	9.50	0.366	0.374
F3	4.50	4.70	0.177	0.185
F4	10.70	10.90	0.421	0.429
F5	3.65	3.85	0.144	0.152
F6	1.25	1.45	0.049	0.057

DOCUMENT NO.  
Z8B00003324

SCALE

EUROPEAN PROJECTION

ISSUE DATE  
30-08-2007

REVISION  
01

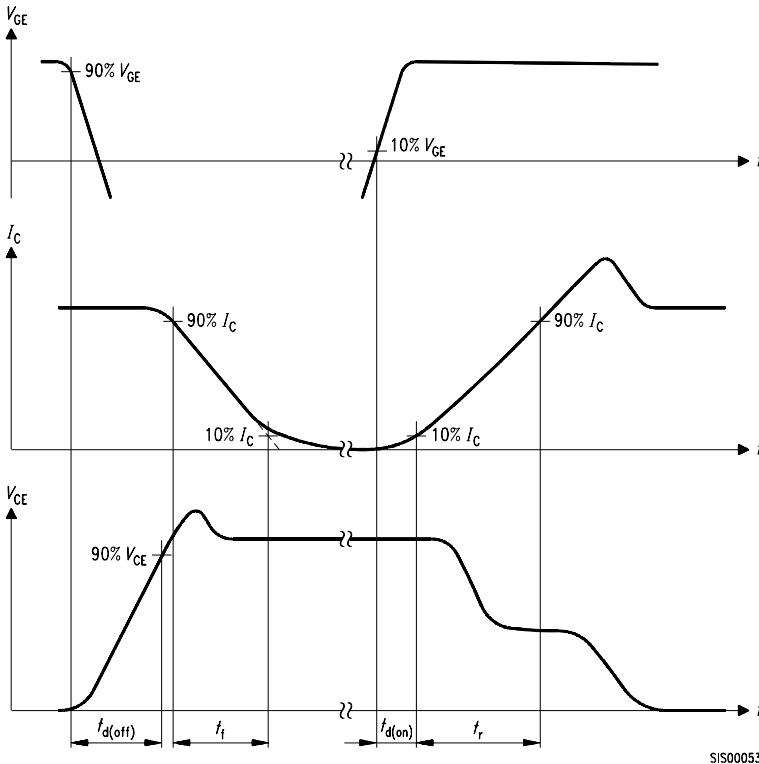


Figure A. Definition of switching times

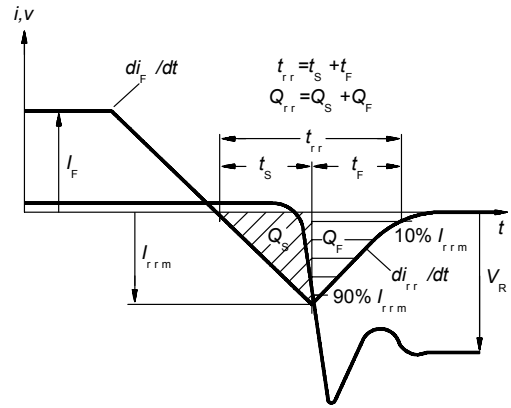


Figure C. Definition of diodes switching characteristics

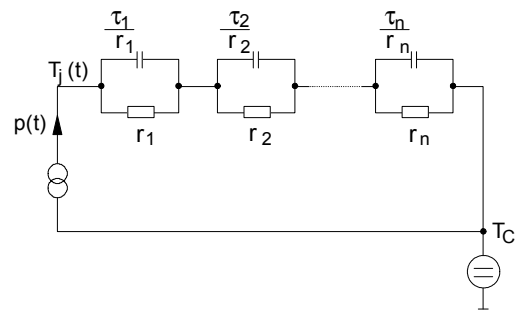


Figure D. Thermal equivalent circuit

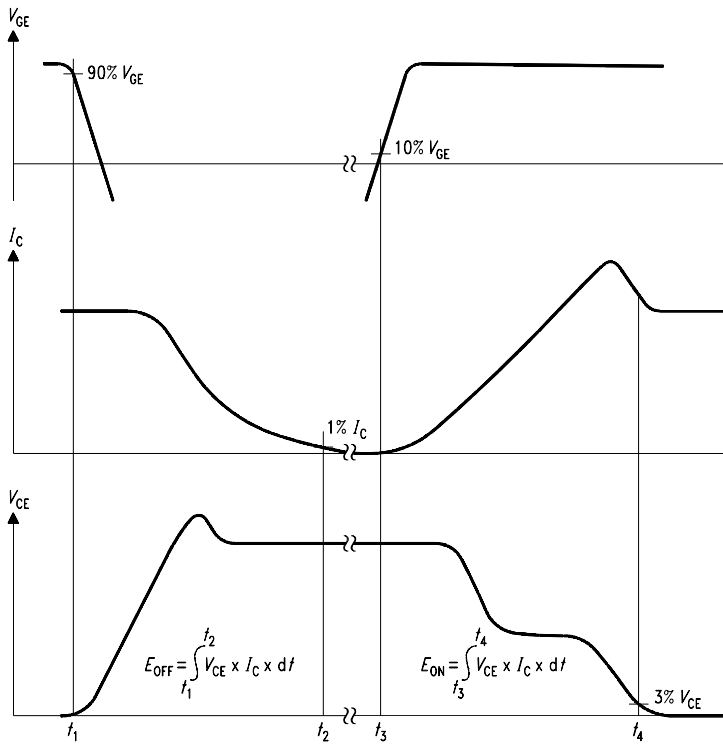


Figure B. Definition of switching losses

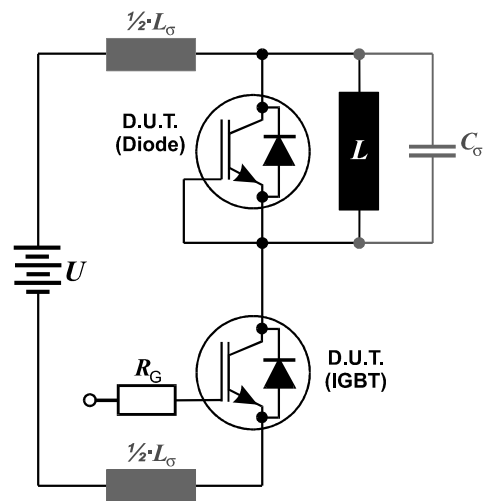


Figure E. Dynamic test circuit  
Leakage inductance  $L_{\sigma} = 60\text{nH}$   
and Stray capacity  $C_{\sigma} = 40\text{pF}$ .

**Edition 2006-01**

**Published by  
Infineon Technologies AG  
81726 München, Germany**

**© Infineon Technologies AG 11/6/07.  
All Rights Reserved.**

**Attention please!**

The information given in this data sheet shall in no event be regarded as a guarantee of conditions or characteristics ("Beschaffheitsgarantie"). With respect to any examples or hints given herein, any typical values stated herein and/or any information regarding the application of the device, Infineon Technologies hereby disclaims any and all warranties and liabilities of any kind, including without limitation warranties of non-infringement of intellectual property rights of any third party.

**Information**

For further information on technology, delivery terms and conditions and prices please contact your nearest Infineon Technologies Office ([www.infineon.com](http://www.infineon.com)).

**Warnings**

Due to technical requirements components may contain dangerous substances. For information on the types in question please contact your nearest Infineon Technologies Office.

Infineon Technologies Components may only be used in life-support devices or systems with the express written approval of Infineon Technologies, if a failure of such components can reasonably be expected to cause the failure of that life-support device or system, or to affect the safety or effectiveness of that device or system. Life support devices or systems are intended to be implanted in the human body, or to support and/or maintain and sustain and/or protect human life. If they fail, it is reasonable to assume that the health of the user or other persons may be endangered.