

Data sheet / Datenblatt 701511500

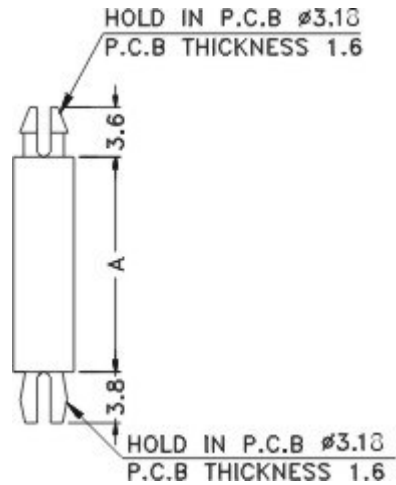

Artikelnr. / Article no. 701511500	Material: Nylon 6/6
Dual Locking Mini Support Post	Colour: Natural
A = 6.4	Geprüft / Drawn Mark Wirth 2007-03-29

Würth Elektronik eiSos GmbH & Co KG
 D – 74638 Waldenburg
 Max-Eyth-Straße 1
 Tel.: 0049 7942-945-0 / Fax: 0049 7942-945-400
www.we-online.de