

PE46130

Document Category: Product Specification

Monolithic Phase & Amplitude Controller, 2.3–2.7 GHz



Features

- 90° phase splitter
- 4-bit digital step attenuator, 7.5 dB range, 0.5 dB resolution
- 5-bit digital phase shifter, 87.2° range, 2.8° resolution
- High power handling and linearity
 - P0.1dB of +35 dBm
 - Input IP3 of +70 dBm
- 3-bit insertion loss stabilizer (ILS)
 - 0.35 dB range, 0.05 dB resolution
- Packaging – 32-lead 6 × 6 × 0.85 mm QFN

Applications

- Wireless infrastructure
 - Macro cells
 - Small cells (micro, pico)
 - Distributed antenna systems (DAS)
- Precision phase shifter
- Dual polarization antenna alignment
- Analog linearization techniques

Figure 1 • PE46130 Functional Diagram

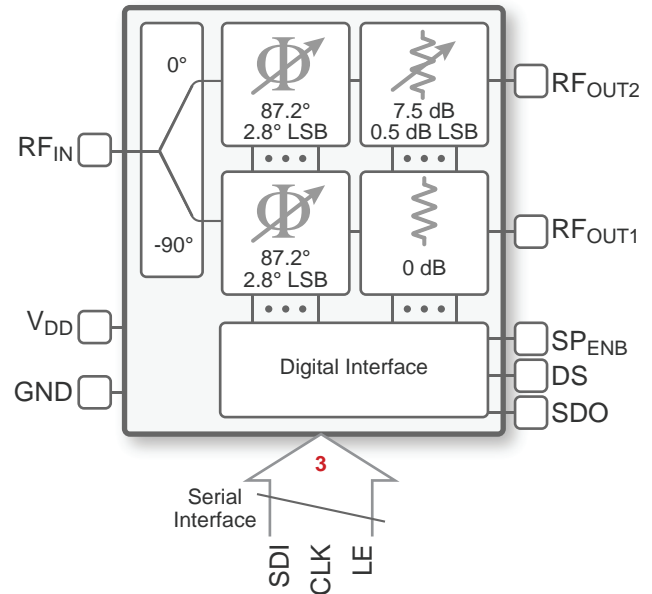

Product Description

The PE46130 is a HaRP™ technology-enhanced monolithic phase and amplitude controller (MPAC) designed for precise phase and amplitude control of two independent RF paths. It optimizes system performance while reducing manufacturing costs of transmitters that use symmetric or asymmetric power amplifier designs to efficiently process signals with large peak-to-average ratios.

This monolithic RFIC integrates a 90° RF splitter, digital phase shifters and a digital step attenuator along with a low voltage CMOS serial interface. It can cover a phase range of 87.2° in 2.8° steps and an attenuation range of 7.5 dB in 0.5 dB steps, while providing excellent phase and amplitude accuracy from 2.3–2.7 GHz.

The PE46130 also features exceptional linearity, high output port-to-port isolation and extremely low power consumption relative to competing module solutions. It is offered in a 32-lead 6 × 6 mm QFN package.

The PE46130 is manufactured on Peregrine's UltraCMOS® process, a patented variation of silicon-on-insulator (SOI) technology on a sapphire substrate, offering the performance of GaAs with the economy and integration of

conventional CMOS. Peregrine’s HaRP technology enhancements deliver high linearity and excellent harmonics performance.

Absolute Maximum Ratings

Exceeding absolute maximum ratings listed in **Table 1** may cause permanent damage. Operation should be restricted to the limits in **Table 2**. Operation between operating range maximum and absolute maximum for extended periods may reduce reliability.

ESD Precautions

When handling this UltraCMOS device, observe the same precautions as with any other ESD-sensitive devices. Although this device contains circuitry to protect it from damage due to ESD, precautions should be taken to avoid exceeding the rating specified in **Table 1**.

Latch-up Immunity

Unlike conventional CMOS devices, UltraCMOS devices are immune to latch-up.

Table 1 • Absolute Maximum Ratings for PE46130

Parameter/Condition	Min	Max	Unit
Supply voltage, V_{DD}	-0.3	5.5	V
Digital input voltage	-0.3	3.6	V
Maximum input power		35	dBm
Storage temperature range	-65	+150	°C
ESD voltage HBM ⁽¹⁾ All pins		1500	V
ESD voltage CDM, RF pins to ground ⁽²⁾		500	V
Notes: 1) Human body model (MIL-STD 883 Method 3015.7). 2) Charged device model (JEDEC JESD22-C101).			

Recommended Operating Conditions

Table 2 lists the recommending operating condition for PE46130. Devices should not be operated outside the recommended operating conditions listed below.

Table 2 • Recommended Operating Condition for PE46130

Parameter	Min	Typ	Max	Unit
Supply voltage, $V_{DD}^{(1)}$	2.3		5.5	V
Supply current		350	500	μ A
Digital input high	1.17		3.6	V
Digital input low	0		0.6	V
Digital input leakage		10	20	μ A
RF input power, CW			29	dBm
RF input power, pulsed ⁽²⁾			32	dBm
Operating temperature range	-40	+25	+105	$^{\circ}$ C
Notes:				
1) Product performance does not vary over V_{DD} .				
2) Pulsed, 5% duty cycle of 4620 μ s period.				

Electrical Specifications

Table 3 provides the PE46130 key electrical specifications at +25 °C, $V_{DD} = 2.3\text{--}5.5\text{V}$, 50Ω , unless otherwise specified.

Table 3 • PE46130 Electrical Specifications at +25 °C

Parameter	Path	Condition	Min	Typ	Max	Unit
Operating frequency			2.3		2.7	GHz
Insertion loss	RF _{IN} to RF _{OUTX}	Reference phase and minimum attenuation state. Includes 3 dB from power divider.		7.2	7.7	dB
Input return loss	RF _{IN}	2.3–2.7 GHz		15		dB
Output return loss	RF _{OUT1} or RF _{OUT2}	2.3–2.7 GHz		15		dB
Isolation	RF _{OUT1} to RF _{OUT2}	2.3–2.7 GHz Reference phase and minimum attenuation state.	26.5	30		dB
Input 0.1dB compression point ⁽¹⁾	RF _{IN} to RF _{OUTX}	2.3–2.7 GHz		35		dBm
Input IP3	RF _{IN} to RF _{OUTX}	2.3–2.7 GHz		70		dBm
Switching time ⁽²⁾		50% LE to 90% or 10% RF final value		980	1220	ns
Phase shift range	RF _{IN} to RF _{OUTX}			87.2		Deg
Phase step				2.8		Deg
Relative phase shift	RF _{OUT1} to RF _{OUT2}	Phase (RF _{OUT1})–Phase (RF _{OUT2}) [same state]		–90		Deg
Attenuation range	RF _{IN} to RF _{OUT2}			7.5		dB
Attenuation step				0.5		dB

Notes:

- 1) The input 0.1dB compression point is a linearity figure of merit. Refer to Table 2 for the operating RF input power (50Ω).
- 2) Worst case state transition. All bits changing.

Table 4 provides the PE46130 key electrical specifications at +105 °C, $V_{DD} = 2.3\text{--}5.5\text{V}$, 50Ω , unless otherwise specified.

Table 4 • PE46130 Electrical Specifications at +105 °C

Parameter	Path	Condition	Min	Typ	Max	Unit
Operating frequency			2.3		2.7	GHz
Insertion loss	RF _{IN} to RF _{OUTX}	Reference phase and minimum attenuation state. Includes 3 dB from power divider.		7.2	8.6	dB
Input return loss	RF _{IN}	2.3–2.7 GHz		15		dB
Output return loss	RF _{OUT1} or RF _{OUT2}	2.3–2.7 GHz		15		dB
Isolation	RF _{OUT1} to RF _{OUT2}	2.3–2.7 GHz Reference phase and minimum attenuation state.	26.5	30		dB
Input 0.1dB compression point ⁽¹⁾	RF _{IN} to RF _{OUTX}	2.3–2.7 GHz		35		dBm
Input IP3	RF _{IN} to RF _{OUTX}	2.3–2.7 GHz		70		dBm
Switching time ⁽²⁾		50% LE to 90% or 10% RF final value		980	1220	ns
Phase shift range	RF _{IN} to RF _{OUTX}			87.2		Deg
Phase step				2.8		Deg
Relative phase shift	RF _{OUT1} to RF _{OUT2}	Phase (RF _{OUT1})–Phase (RF _{OUT2}) [same state]		–90		Deg
Attenuation range	RF _{IN} to RF _{OUT2}			7.5		dB
Attenuation step				0.5		dB

Notes:

- 1) The input 0.1dB compression point is a linearity figure of merit. Refer to Table 2 for the operating RF input power (50Ω).
- 2) Worst case state transition. All bits changing.

Switching Frequency

The PE46130 has a maximum 25 kHz switching frequency.

The switching frequency is defined to be the rate at which the PE46130 can be continuously toggled across attenuation and phase states.

Thermal Data

Psi-JT (Ψ_{JT}), junction top-of-package, is a thermal metric to estimate junction temperature of a device on the customer application PCB (JEDEC JESD51-2).

$$\Psi_{JT} = (T_J - T_T)/P$$

where

Ψ_{JT} = junction-to-top of package characterization parameter, °C/W

T_J = die junction temperature, °C

T_T = package temperature (top surface, in the center), °C

P = power dissipated by device, Watts

Table 5 • Thermal Data for PE46130

Parameter	Typ	Unit
Maximum junction temperature, T_{JMAX} +105°C ambient	123.3	°C
Ψ_{JT}	3.1	°C/W

Control Logic

Table 6–Table 13 provide the control logic truth tables for the PE46130.

Table 6 • Bit Descriptions

C0	Channel register select
	C0 = L, channel RF _{OUT1} register select
	C0 = H, channel RF _{OUT2} register select
M0–M3	Attenuation setting per channel in dB
P0–P4	Phase shift setting per channel in deg
S0–S3	Insertion loss stabilizer setting per channel

Table 7 • 14-bit Word

Q13	Q12	Q11	Q10	Q9	Q8	Q7	Q6	Q5	Q4	Q3	Q2	Q1	Q0
C0	S3	S2	M3	M2	M1	M0	P4	P3	P2	P1	P0	S1	S0
1	—	—	—	—	—	—	45	22.5	11.2	5.6	2.8	—	—
2	—	0.2	4	2	1	0.5	45	22.5	11.2	5.6	2.8	0.1	0.05

Table 8 • Serial Truth Table – Phase Setting

Q13	Q12	Q11	Q10	Q9	Q8	Q7	Q6	Q5	Q4	Q3	Q2	Q1	Q0	Phase Shift Setting
C0	S3	S2	M3	M2	M1	M0	P4	P3	P2	P1	P0	S1	S0	
1/2	—	0.2	4	2	1	0.5	45	22.5	11.2	5.6	2.8	0.1	0.05	
X	L	X	X	X	X	X	L	L	L	L	L	X	X	Ref Phase
X	L	X	X	X	X	X	L	L	L	L	H	X	X	2.8 deg
X	L	X	X	X	X	X	L	L	L	H	L	X	X	5.6 deg
X	L	X	X	X	X	X	L	L	H	L	L	X	X	11.25 deg
X	L	X	X	X	X	X	L	H	L	L	L	X	X	22.5 deg
X	L	X	X	X	X	X	H	L	L	L	L	X	X	45 deg
X	L	X	X	X	X	X	H	H	H	H	H	X	X	87.2 deg

Table 9 • Serial Truth Table – Attenuation Setting (RF_{OUT2})

Q13	Q12	Q11	Q10	Q9	Q8	Q7	Q6	Q5	Q4	Q3	Q2	Q1	Q0	Amplitude Setting
C0	S3	S2	M3	M2	M1	M0	P4	P3	P2	P1	P0	S1	S0	
2	—	0.2	4	2	1	0.5	45	22.5	11.2	5.6	2.8	0.1	0.05	
H	L	X	L	L	L	L	X	X	X	X	X	X	X	Ref Insertion Loss
H	L	X	L	L	L	H	X	X	X	X	X	X	X	0.5 dB
H	L	X	L	L	H	L	X	X	X	X	X	X	X	1 dB
H	L	X	L	H	L	L	X	X	X	X	X	X	X	2 dB
H	L	X	H	L	L	L	X	X	X	X	X	X	X	4 dB
H	L	X	H	H	H	H	X	X	X	X	X	X	X	7.5 dB

Table 10 • Default State Settings at Power Up (RF_{OUT1})

DS Setting	Q13	Q12	Q11	Q10	Q9	Q8	Q7	Q6	Q5	Q4	Q3	Q2	Q1	Q0	Default Setting at Power Up
	C0	S3	S2	M3	M2	M1	M0	P4	P3	P2	P1	P0	S1	S0	
	1/2	—	0.2	4	2	1	0.5	45	22.5	11.2	5.6	2.8	0.1	0.05	
DS = 0	—	—	—	—	—	—	—	L	L	L	L	L	—	—	0 dB 0 deg
DS = 1	—	—	—	—	—	—	—	H	L	L	L	L	—	—	0 dB 45 deg

Table 11 • Default State Settings at Power Up (RF_{OUT2})

DS Setting	Q13	Q12	Q11	Q10	Q9	Q8	Q7	Q6	Q5	Q4	Q3	Q2	Q1	Q0	Default Setting at Power Up
	C0	S3	S2	M3	M2	M1	M0	P4	P3	P2	P1	P0	S1	S0	
	1/2	—	0.2	4	2	1	0.5	45	22.5	11.2	5.6	2.8	0.1	0.05	
DS = 0	—	L	L	L	L	L	L	L	L	L	L	L	L	L	0 dB 0 deg
DS = 1	—	L	L	H	H	H	H	H	L	L	L	L	L	L	7.5 dB 45 deg

Insertion Loss Stabilizer

The PE46130 offers greater insertion loss stability by compensating for known variations between phase states. Three attenuation bits are used to reduce the variation seen in the insertion loss across all phase states for the RF_{OUT2} path. ILS bits S0–S2 are accessible for creating a custom lookup table in applications where insertion loss variation between phase states is critical.

Table 12 • Insertion Loss Stabilizer Bit Definition

Q13	Q12	Q11	Q10	Q9	Q8	Q7	Q6	Q5	Q4	Q3	Q2	Q1	Q0	Amplitude Setting
C0	S3	S2	M3	M2	M1	M0	P4	P3	P2	P1	P0	S1	S0	
2	—	0.2	4	2	1	0.5	45	22.5	11.2	5.6	2.8	0.1	0.05	
X	X	X	X	X	X	X	X	X	X	X	X	X	X	
H	L	L	X	X	X	X	X	X	X	X	X	L	L	Ref IL
H	L	L	X	X	X	X	X	X	X	X	X	L	H	.05 dB
H	L	L	X	X	X	X	X	X	X	X	X	H	L	.1 dB
H	L	H	X	X	X	X	X	X	X	X	X	L	L	.2 dB
H	L	H	X	X	X	X	X	X	X	X	X	H	H	.35 dB

Table 13 • Serial Interface Timing Characteristics ⁽¹⁾

Parameter/Condition	Min	Max	Unit
Serial clock frequency, F _{CLK} ⁽²⁾	0.032	26	MHz
Serial clock period, T _{SCLK}	40		ns
Serial clock HIGH time, T _{SCLKH}	20		ns
Serial clock LOW time, T _{SCLKL}	20		ns
Serial data output propagation delay from CLK falling edge, T _{OV} (10 pF)		9	ns
Latch clock pulse width high, T _{LCLKH}	10		ns
Serial data input setup time from CLK rising edge, T _{SU}		5	ns
Serial data input hold time from CLK rising edge, T _H		2	ns
Serial data output hold time from CLK rising edge, T _{OH}	1.6		ns
Serial clock rising edge setup time to latch clock rising edge, T _{SETTLE}		27	ns
SDO drive strength ⁽³⁾		15	pF

Notes:

- 1) V_{DD} = 2.3V–5.5V, –40 °C < T_A < +105 °C, unless otherwise specified.
- 2) Limited by test duration not static logic design. Synchronous to clock. Minimum clock frequency tested = 32 kHz.
- 3) SDO maximum capacitive load drive strength for F_{CLK} = 26 MHz with a 1.8V swing.

Programming Options

Serial Interface

The serial interface is a 14-bit serial-in shift register with two parallel-out channel registers RF_{OUT1} and RF_{OUT2} buffered by a transparent latch. The 14 bits comprise four bits defining the attenuation setting, five bits for the phase shift setting and three bits for the insertion loss stabilization feature. Channel register RF_{OUT1} and RF_{OUT2} selection is determined by the value of the C0 bit contained as part of the 14-bit program word.

The serial interface is controlled using three CMOS compatible signals: serial data in (SDI), clock (CLK) and latch enable (LE). The SDI and CLK inputs allow data to be serially entered into the shift register. Serial data is clocked in starting with two ILS LSB bits first and then the phase setting LSB. The shift register

must be loaded while LE is held LOW to prevent the internal channel register values from changing as data is entered. The LE input should then be toggled HIGH, latching the new data into the PE46130. SDO is a clock delayed reply of the user's input SDI command for functional confirmation.

Phase shift, attenuation and insertion loss stabilizer setting truth tables are listed in **Table 8**, **Table 9** and **Table 12**. The serial timing diagram is illustrated in **Figure 2** and associated AC characteristics are listed in **Table 13**.

Power-up Control Settings

The PE46130 will power up in one of two default states depending upon the setting of the default state (DS) pin, as defined in **Table 10** and **Table 11**. No specific signal sequencing is required for the default state to be set and active once V_{DD} is applied.

Figure 2 • Latched Buffered SDO Serial Interface

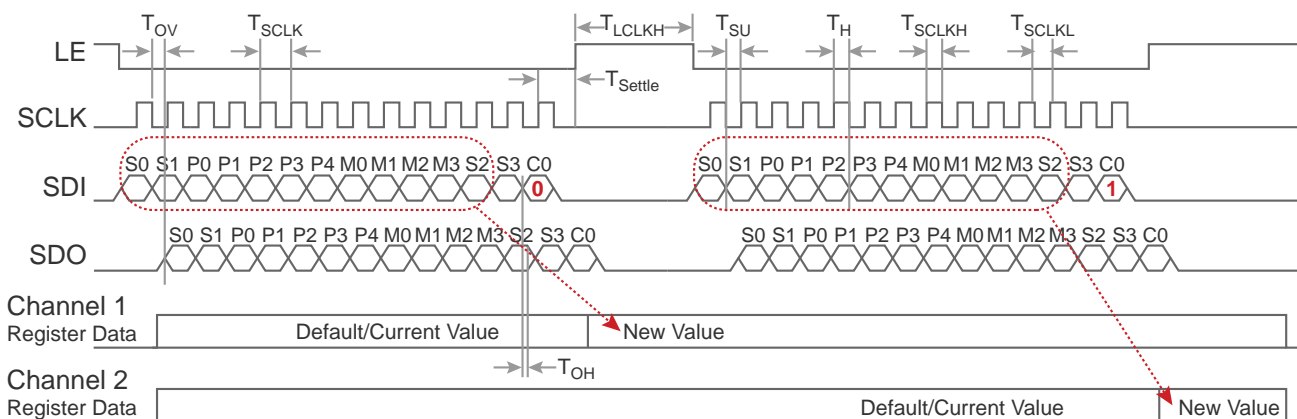

Typical Performance Data

Figure 3–Figure 21 show the typical performance data at 25 °C, $V_{DD} = 2.3\text{--}5.5\text{V}$, 50Ω , unless otherwise specified.

Figure 3 • *Relative Phase Shift ($RF_{OUT1}\text{--}RF_{OUT2}$)*

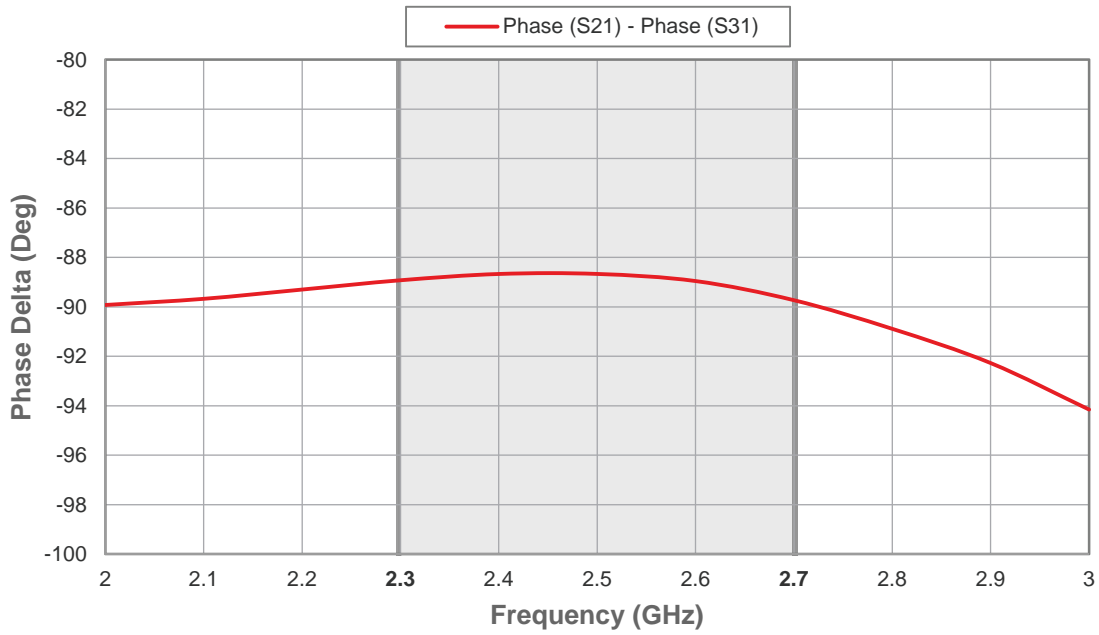

Figure 4 • Insertion Loss (RF_{IN} - RF_{OUT1})

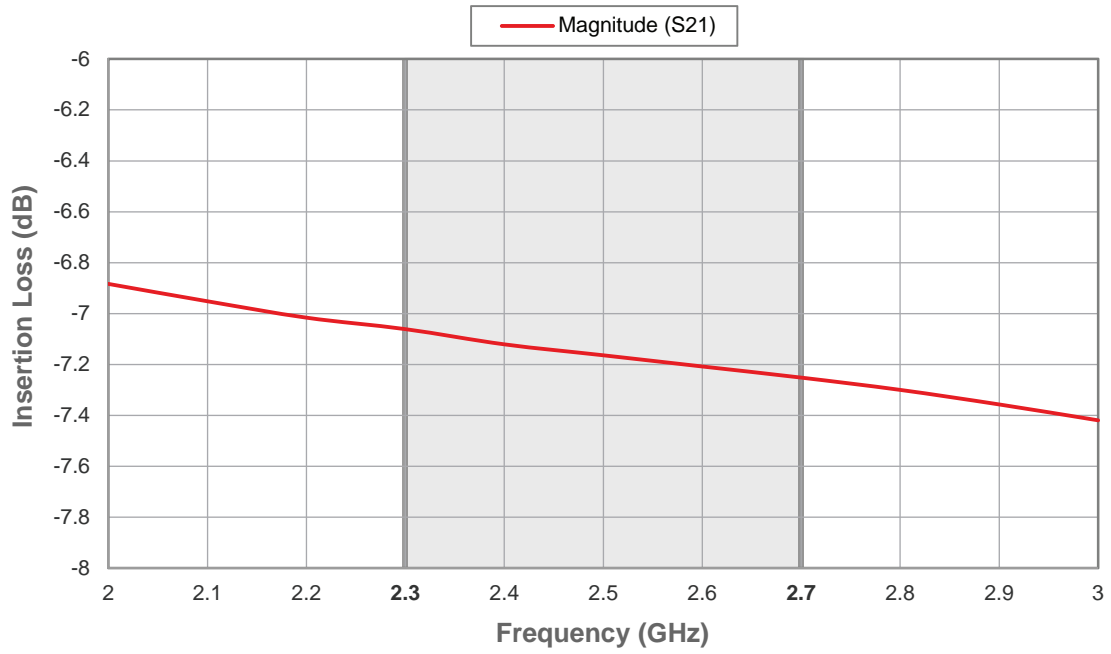

Figure 5 • Insertion Loss (RF_{IN} - RF_{OUT2})

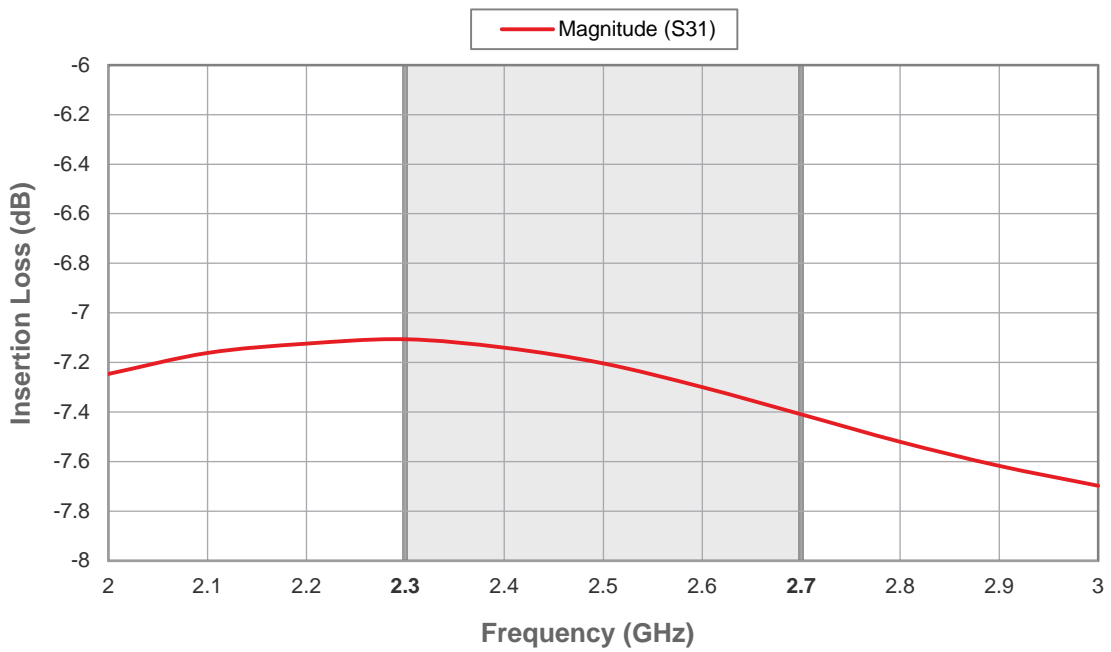

Figure 6 • Insertion Loss $RF_{IN}-RF_{OUT2}$ (All RF_{OUT2} Attenuation States)

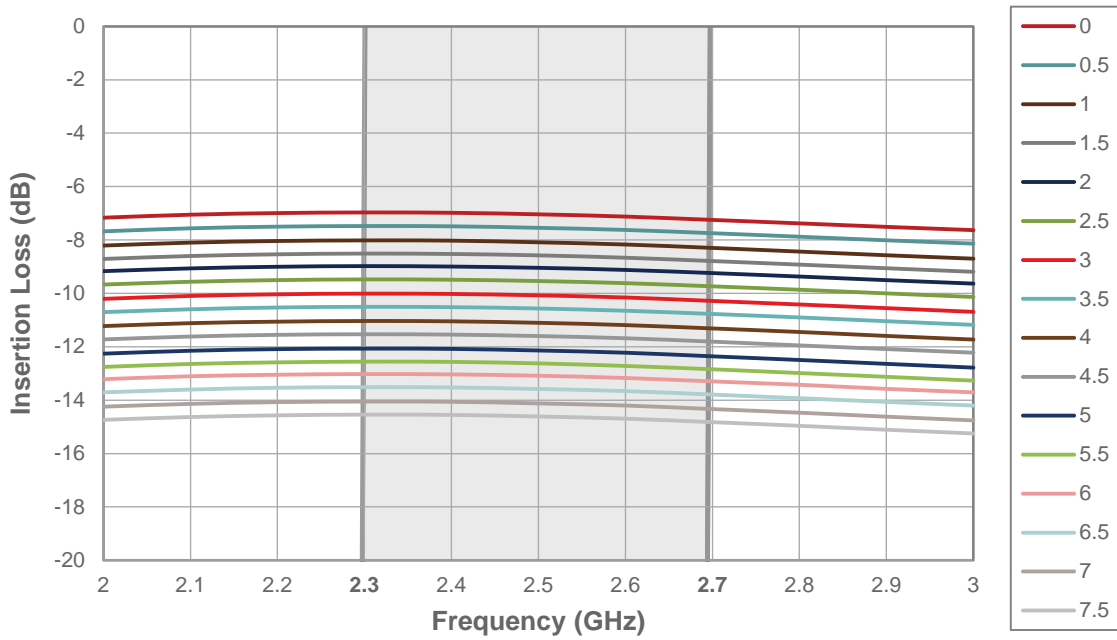

Figure 7 • Relative Phase $RF_{IN}-RF_{OUT1}$ (All RF_{OUT1} Phase States)

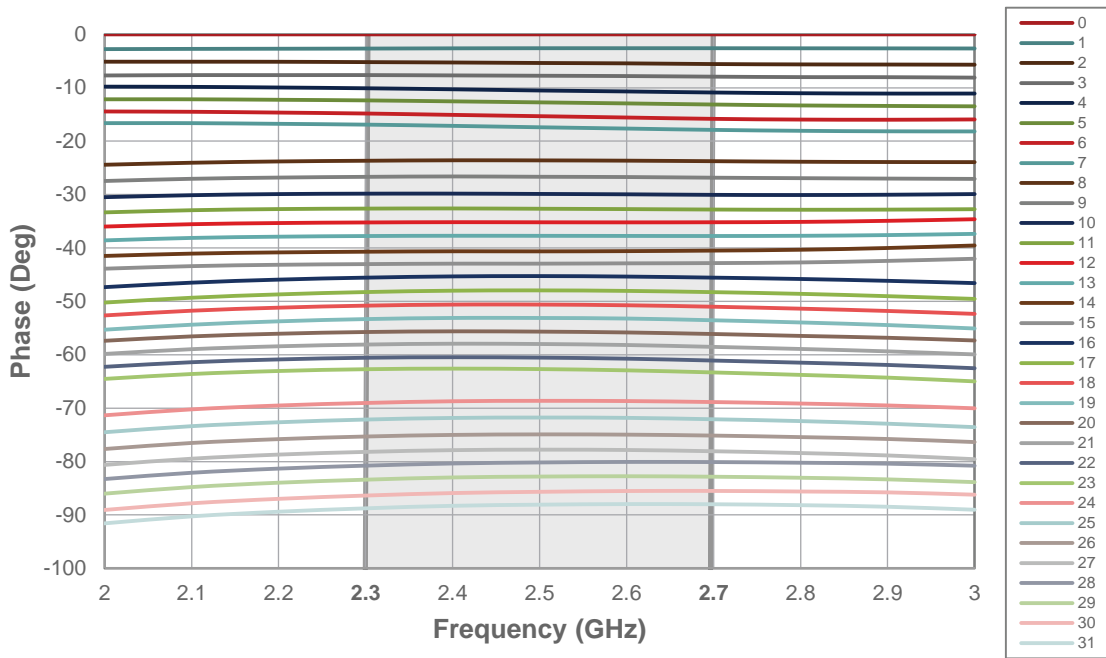

Figure 8 • Relative Phase $RF_{IN}-RF_{OUT2}$ (All RF_{OUT2} Phase States)

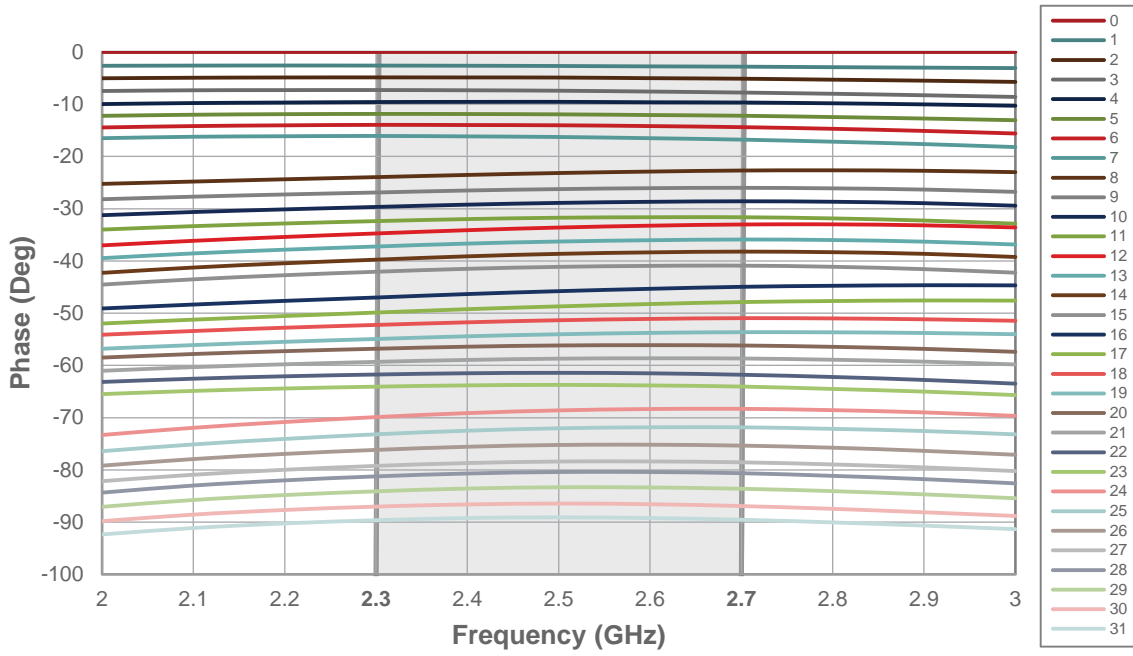

Figure 9 • Input Return Loss (All States)

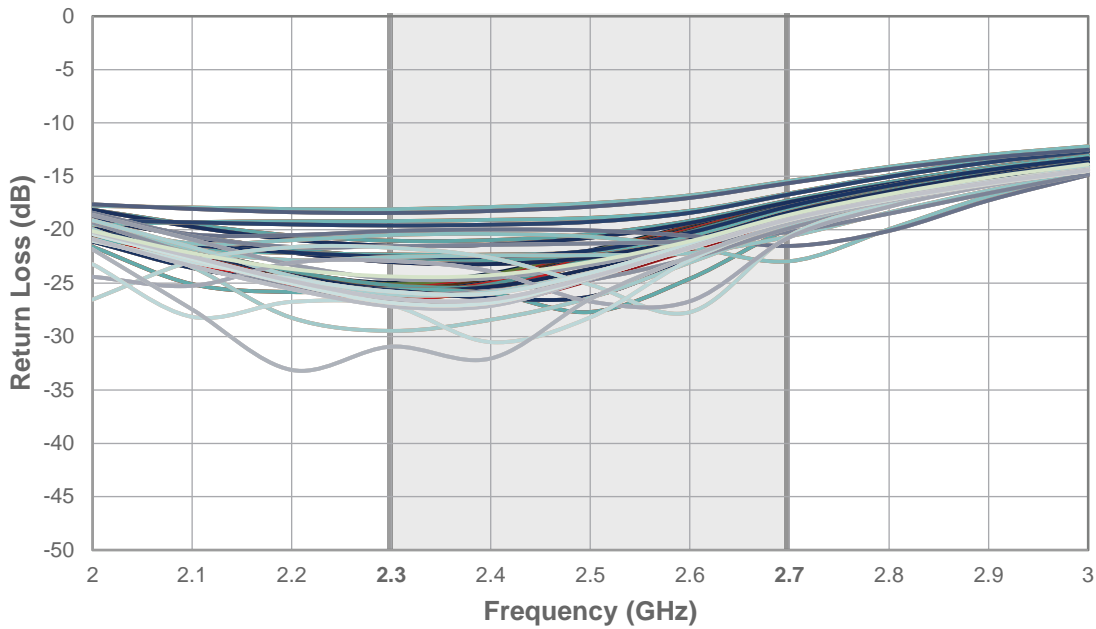

Figure 10 • Output Return Loss RF_{OUT1} (All RF_{OUT1} Phase States)

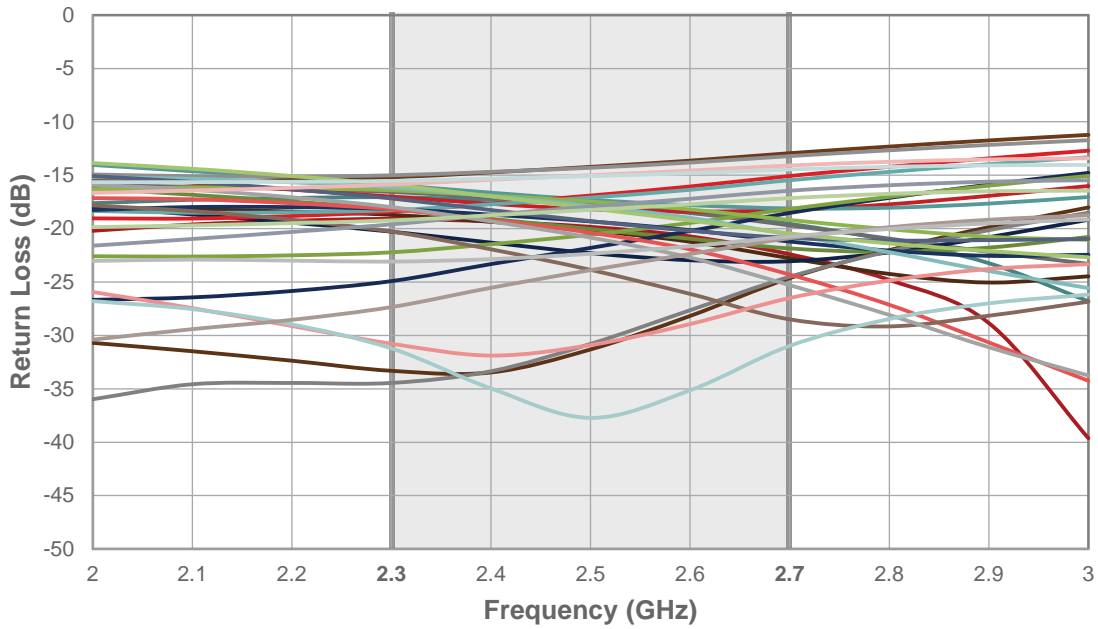

Figure 11 • Output Return Loss RF_{OUT2} (All RF_{OUT2} Phase States)

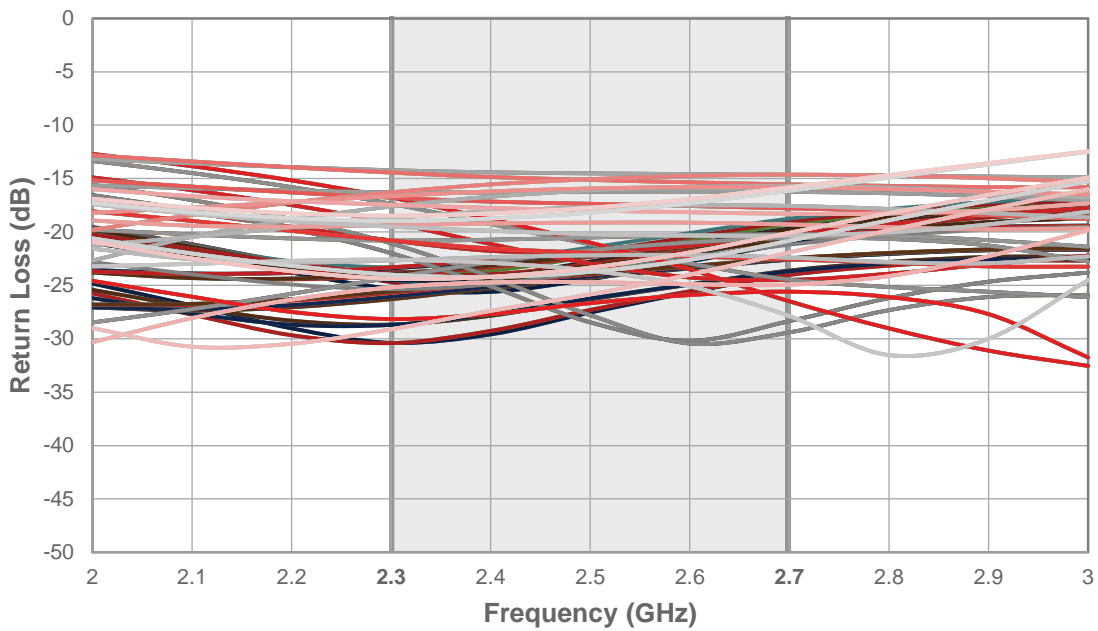

Figure 12 • Isolation Output Ports (All States)

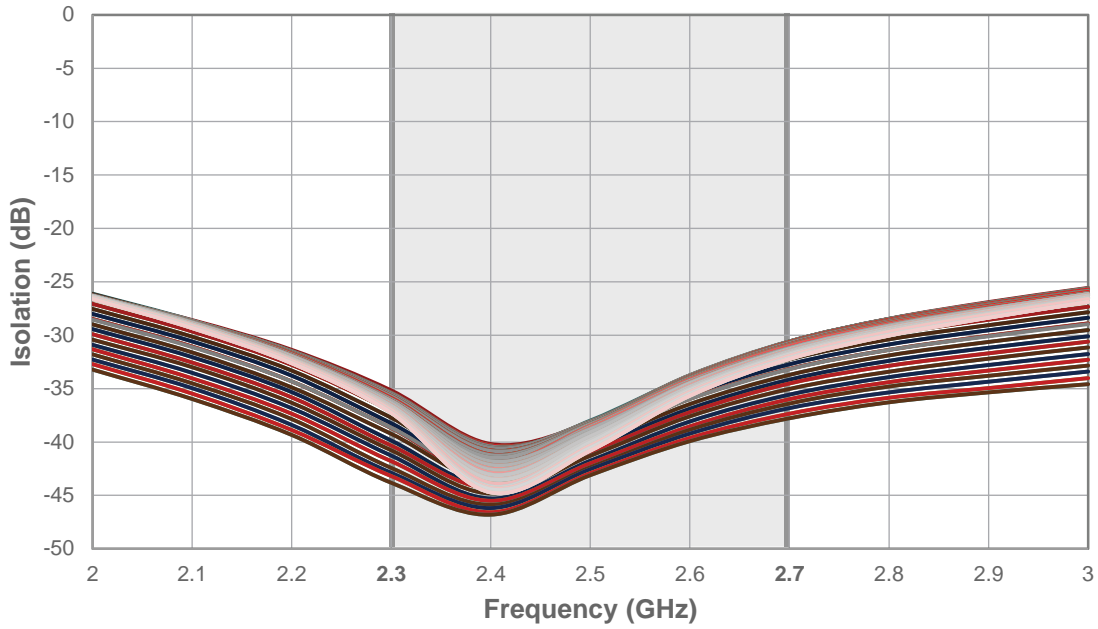

Figure 13 • RF_{OUT1} Insertion Loss Variation Across RF_{OUT2} Phase State

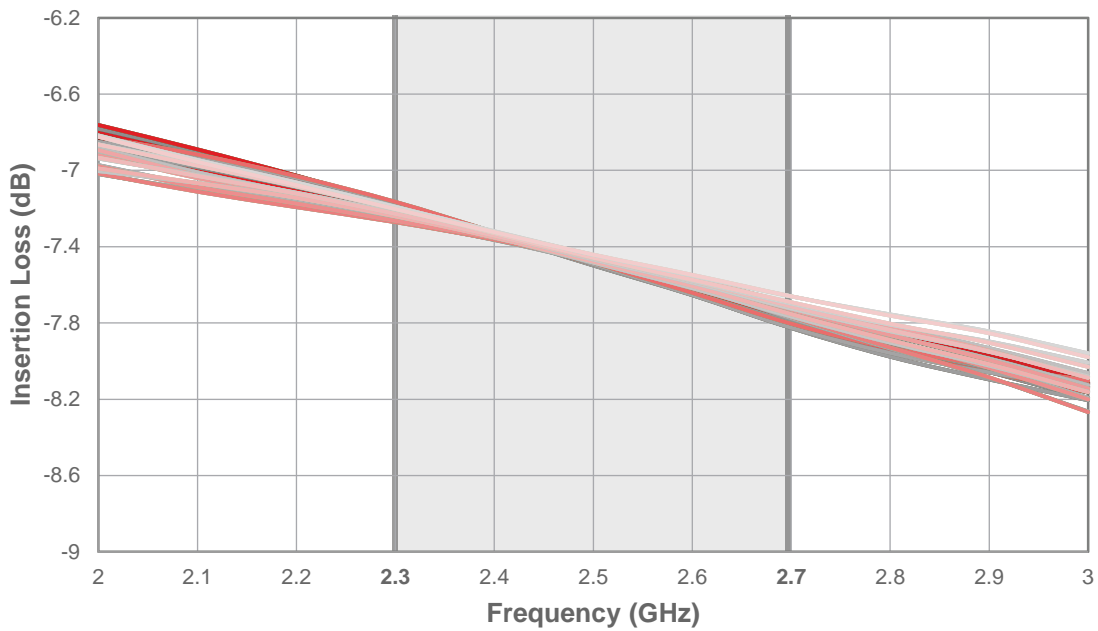

Figure 14 • RF_{OUT1} Phase Variation Across all RF_{OUT2} Phase States

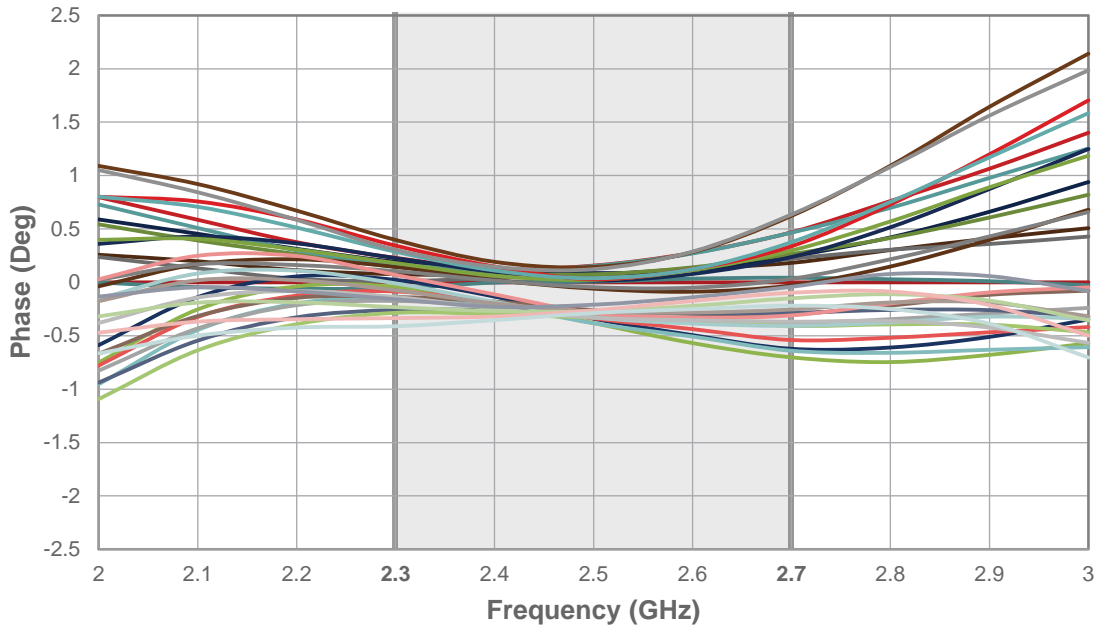

Figure 15 • RF_{OUT1} Insertion Loss Variation Across RF_{OUT1} Phase State

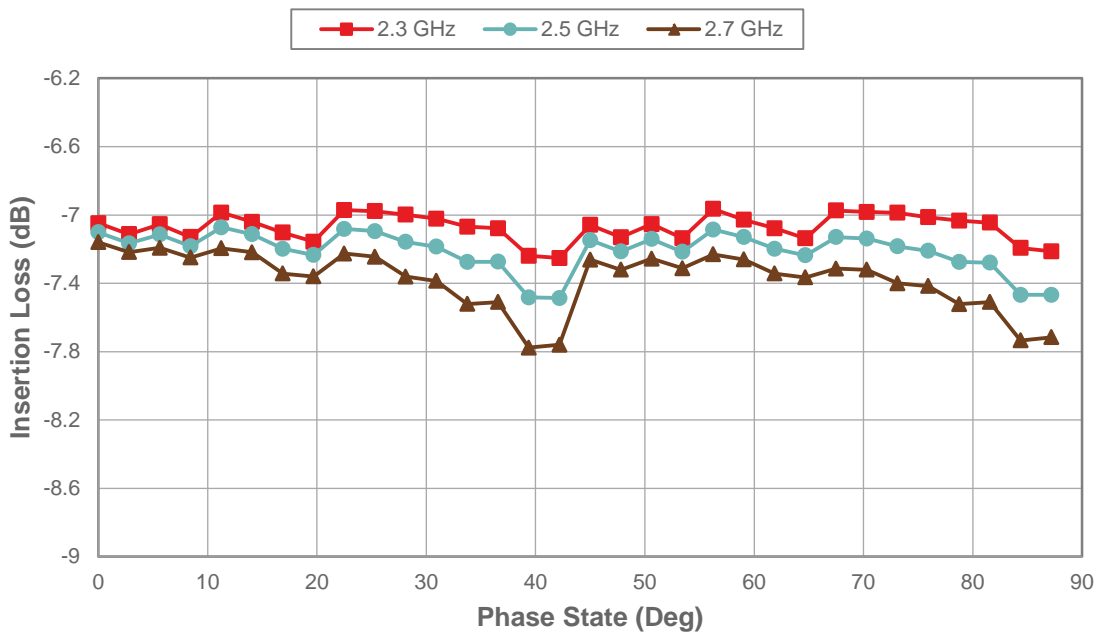

Figure 16 • RF_{OUT2} Insertion Loss Variation Across RF_{OUT2} Phase State

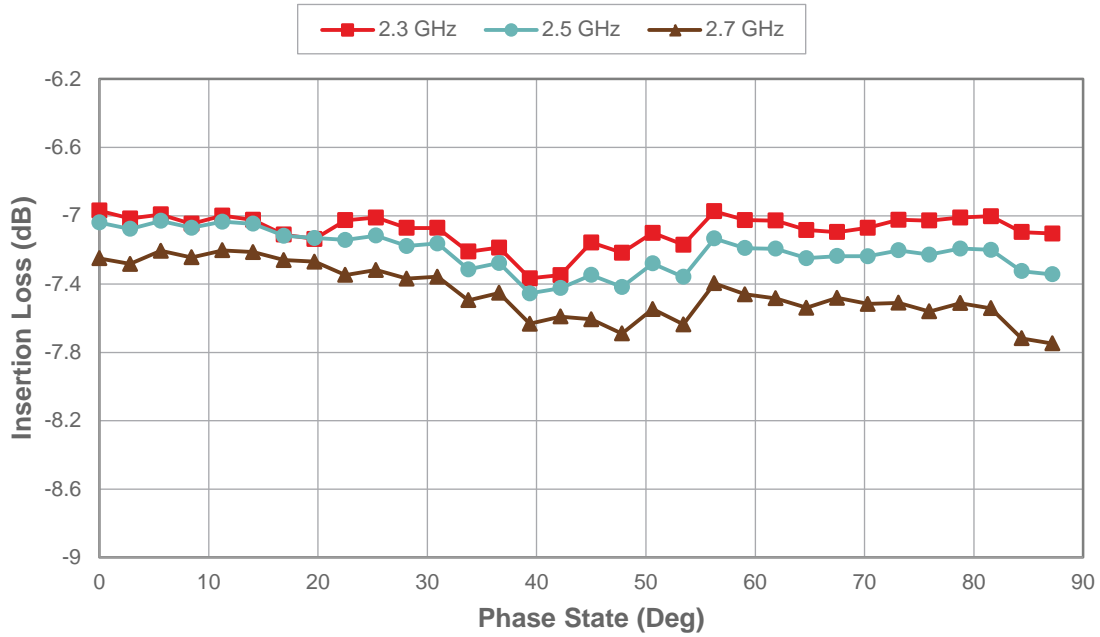

Figure 17 • RF_{OUT2} Phase Variation Across RF_{OUT2} Attenuation State

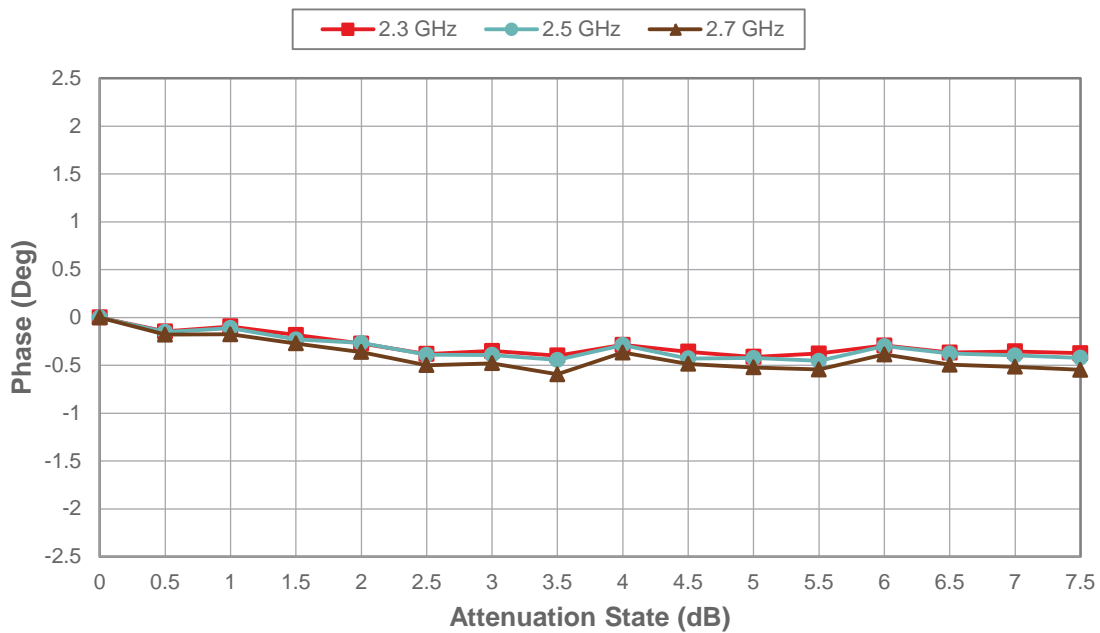

Figure 18 • RF_{OUT2} Insertion Loss Across RF_{OUT2} Attenuation State vs V_{DD} Frequency = 2.5 GHz

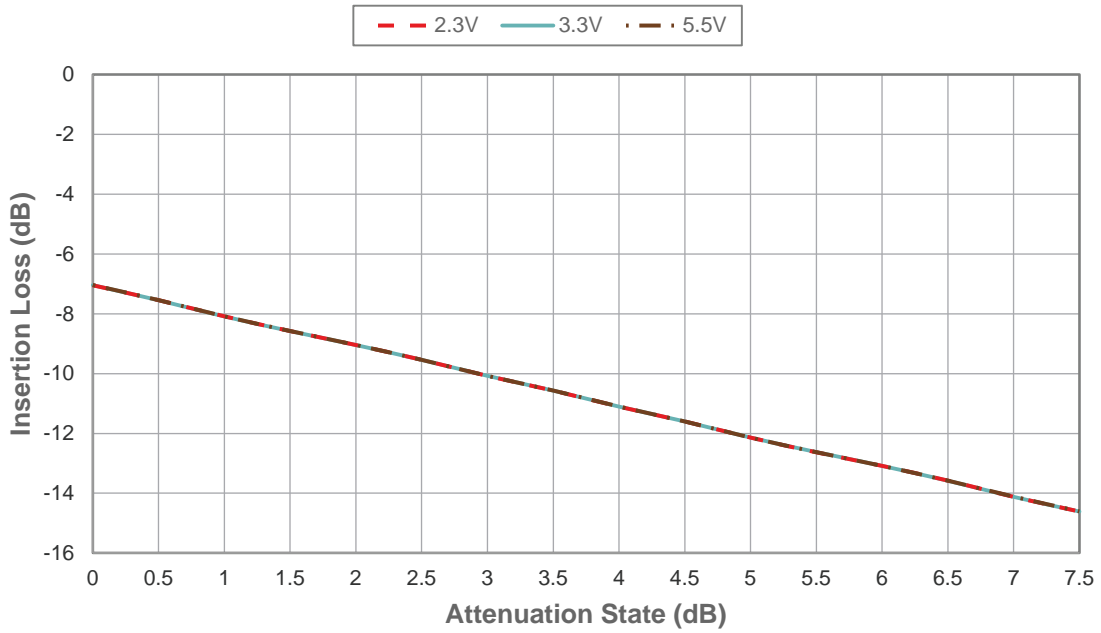

Figure 19 • RF_{OUT2} Insertion Loss Across RF_{OUT2} Attenuation State vs Temperature, Frequency = 2.5 GHz

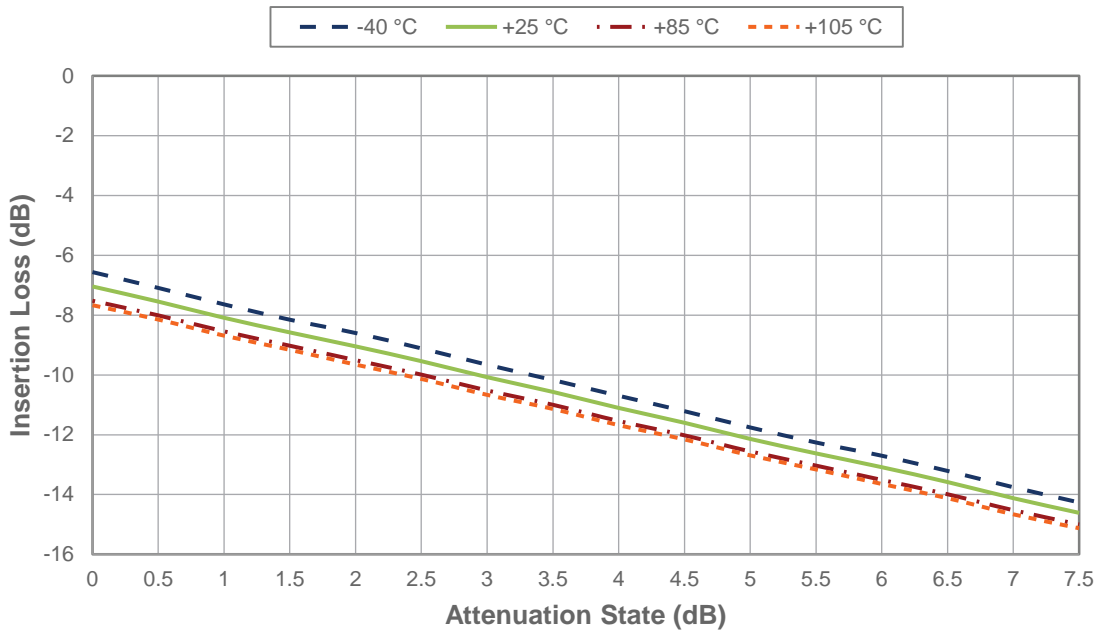

Figure 20 • RF_{OUT2} Relative Phase State Across RF_{OUT2} Phase State vs V_{DD} , Frequency = 2.5 GHz

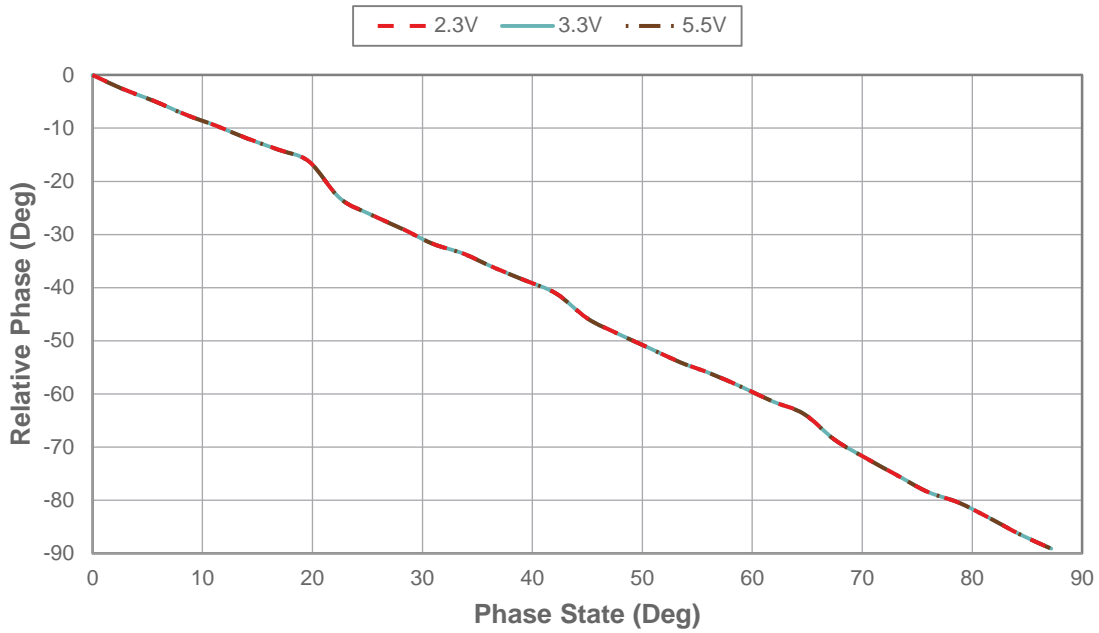
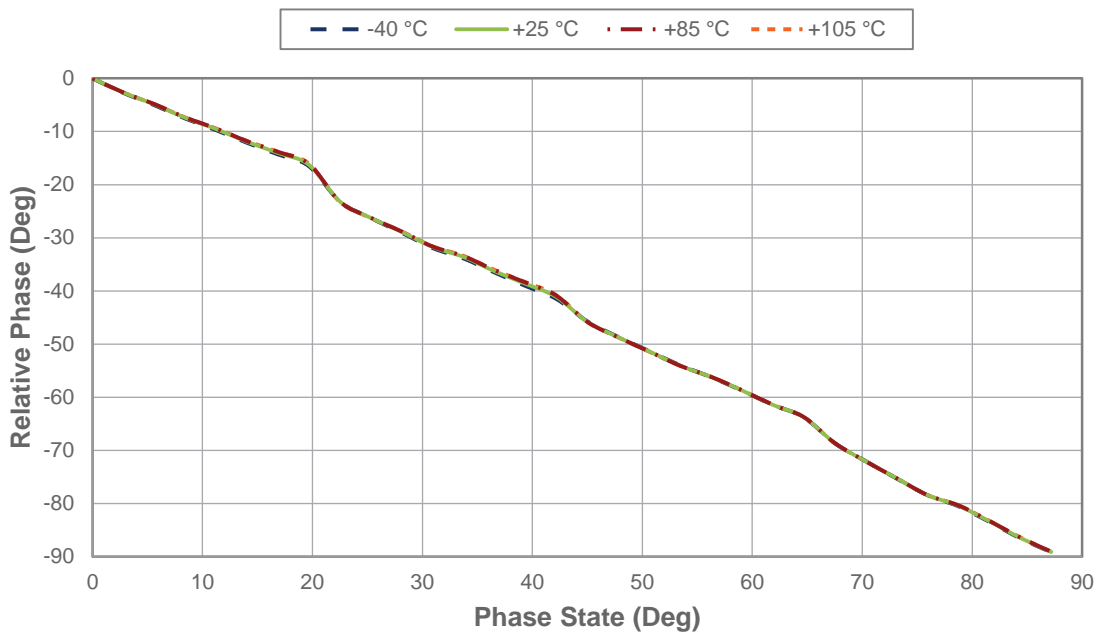

Figure 21 • RF_{OUT2} Relative Phase State Across RF_{OUT2} Phase State vs Temperature, Frequency = 2.5 GHz



Pin Information

This section provides pinout information for the PE46130. **Figure 22** shows the pin map of this device for the available package. **Table 14** provides a description for each pin.

Figure 22 • Pin Configuration (Top View)

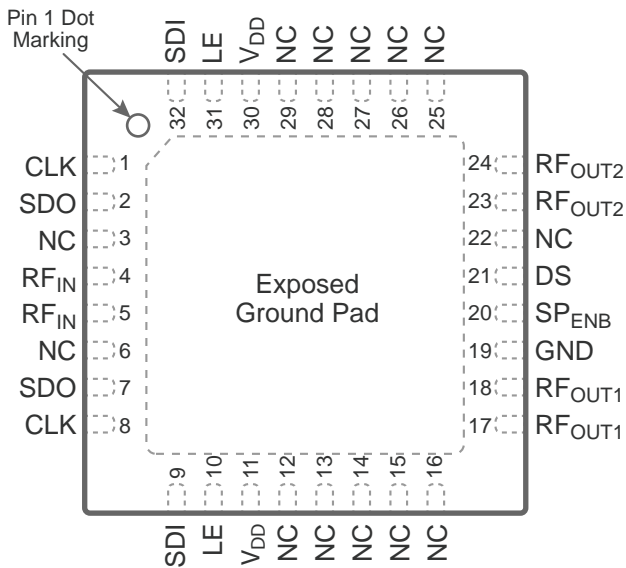

Table 14 • Pin Descriptions for PE46130

Pin No.	Pin Name	Description
1, 8	CLK ⁽¹⁾	Clock input
2, 7	SDO ⁽²⁾	Serial data output
3, 6, 12–16, 22, 25–29	NC	No connect
4, 5	RF _{IN} ⁽³⁾	RF input
9, 32	SDI ⁽¹⁾	Serial data input
10, 31	LE ⁽¹⁾	Latch enable
11, 30	V _{DD} ⁽¹⁾	Supply voltage
17, 18	RF _{OUT1} ⁽³⁾	RF output 1
19	GND ⁽⁴⁾	Ground
20	SP _{ENB} ⁽⁵⁾⁽⁶⁾	Serial port enable
21	DS ⁽⁶⁾	Default state at power up select
23, 24	RF _{OUT2} ⁽³⁾	RF output 2
Pad	GND	Exposed pad: ground for proper operation

Notes:

- 1) Pins are internally connected, signal only needs to be applied to one of the pins. The alternate unused pin needs to be left floating.
- 2) SDOs are independently buffered outputs of the same signal.
- 3) RF pins 4, 5, 17 and 18 must be at 0 VDC. The RF pins do not require DC blocking capacitors for proper operation if the 0 VDC requirement is met.
- 4) Pin 19 must be grounded for proper function.
- 5) Must be active low for normal SPI operation. Logic high programs 0 dB attenuation setting and 0° phase setting. Setting back to logic low returns to the previously programmed state.
- 6) Pin has an internal 100 kΩ pull-up resistor.

Packaging Information

This section provides packaging data including the moisture sensitivity level, package drawing, package marking and tape-and-reel information.

Moisture Sensitivity Level

The moisture sensitivity level rating for the PE46130 in the 32-lead 6 × 6 × 0.85 mm QFN package is MSL1.

Package Drawing

Figure 23 • Package Mechanical Drawing for 32-lead 6 × 6 × 0.85 mm QFN

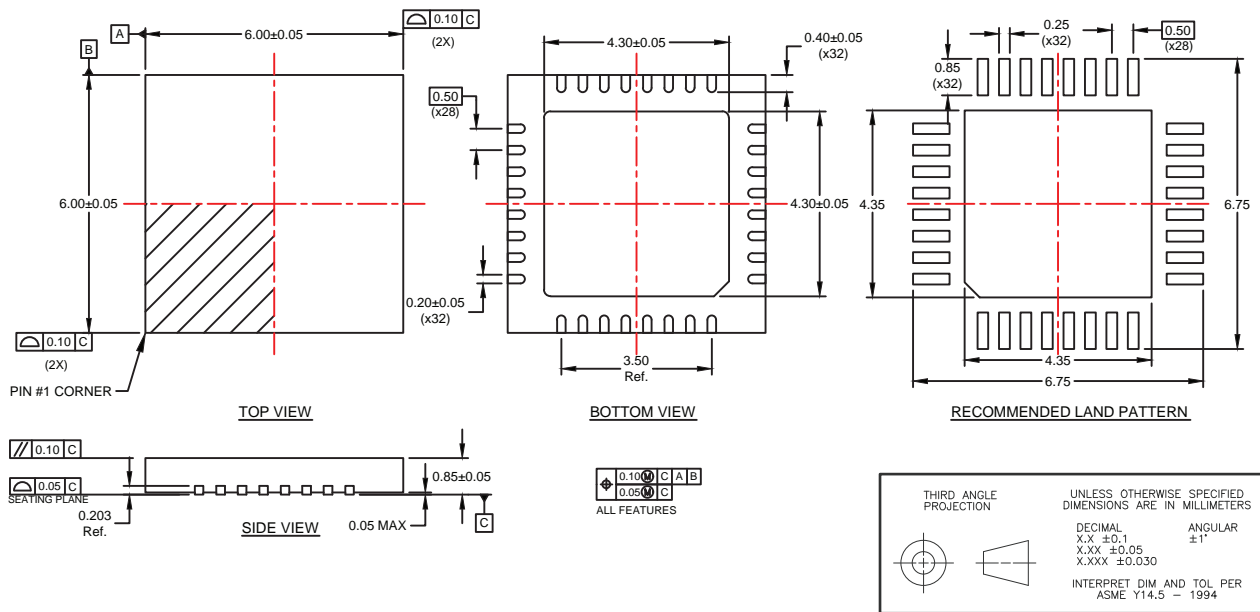

Top-Marking Specification

Figure 24 • Package Marking Specifications for PE46130



- = Pin 1 indicator
- YY = Last two digits of assembly year
- WW = Assembly work week
- ZZZZZZZZ = Assembly lot code (maximum eight characters)

Tape and Reel Specification

Figure 25 • Tape and Reel Specifications for 32-lead 6 × 6 × 0.85 mm QFN

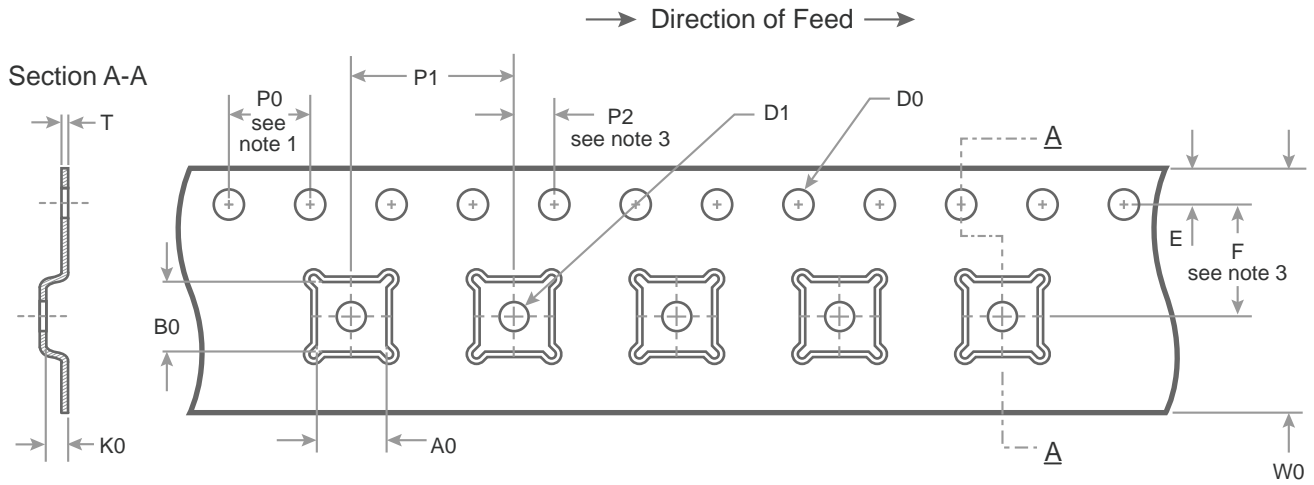

A0	6.30 ± 0.10
B0	6.30 ± 0.10
K0	1.10 ± 0.10
D0	1.50 + 0.1/-0.0
D1	1.5 min
E	1.75 ± 0.10
F	7.50 ± 0.10
P0	4.00
P1	12.00 ± 0.10
P2	2.00 ± 0.10
T	0.30 ± 0.05
W0	16.00 ± 0.30

Notes:

1. 10 Sprocket hole pitch cumulative tolerance ±0.2
2. Camber in compliance with EIA 481
3. Pocket position relative to sprocket hole measured as true position of pocket, not pocket hole

Dimensions are in millimeters unless otherwise specified

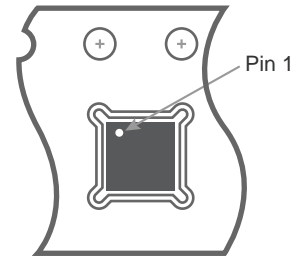

Device Orientation in Tape

Ordering Information

Table 15 lists the available ordering codes for the PE46130 as well as available shipping methods.

Table 15 • Order Codes for PE46130

Order Codes	Description	Packaging	Shipping Method
PE46130A–X	PE46130 monolithic phase and amplitude controller	Green 32-lead 6 x 6 mm QFN	500 units/T&R
EK46130–02	PE46130 Evaluation kit	Evaluation kit	1/box

Document Categories

Advance Information

The product is in a formative or design stage. The datasheet contains design target specifications for product development. Specifications and features may change in any manner without notice.

Preliminary Specification

The datasheet contains preliminary data. Additional data may be added at a later date. Peregrine reserves the right to change specifications at any time without notice in order to supply the best possible product.

Product Specification

The datasheet contains final data. In the event Peregrine decides to change the specifications, Peregrine will notify customers of the intended changes by issuing a CNF (Customer Notification Form).

Sales Contact

For additional information, contact Sales at sales@psemi.com.

Disclaimers

The information in this document is believed to be reliable. However, Peregrine assumes no liability for the use of this information. Use shall be entirely at the user's own risk. No patent rights or licenses to any circuits described in this document are implied or granted to any third party. Peregrine's products are not designed or intended for use in devices or systems intended for surgical implant, or in other applications intended to support or sustain life, or in any application in which the failure of the Peregrine product could create a situation in which personal injury or death might occur. Peregrine assumes no liability for damages, including consequential or incidental damages, arising out of the use of its products in such applications.

Patent Statement

Peregrine products are protected under one or more of the following U.S. patents: patents.psemi.com

Copyright and Trademark

©2014–2016, Peregrine Semiconductor Corporation. All rights reserved. The Peregrine name, logo, UTSi and UltraCMOS are registered trademarks and HaRP, MultiSwitch and DuNE are trademarks of Peregrine Semiconductor Corp.

Product Brief

This document contains a shortened version of the datasheet. For the full datasheet, contact sales@psemi.com.

Not Recommended for New Designs (NRND)

This product is in production but is not recommended for new designs.

End of Life (EOL)

This product is currently going through the EOL process. It has a specific last-time buy date.

Obsolete

This product is discontinued. Orders are no longer accepted for this product.