

Charge Pump for Backlight/Flash/RGB LEDs with Safety Timer

General Description

The MAX8879 provides complete light management for main display backlight, subdisplay backlight (or RGB indicator), and white LED camera flash with regulated constant current up to 610mA total. By utilizing adaptive 1x/1.5x/2x charge-pump modes and very-low-dropout current regulators, it achieves high efficiency over the full 1-cell Li+ battery input voltage range. The 1MHz fixed-frequency switching allows for tiny external components while the regulation scheme is optimized to ensure low EMI and low input ripple. An integrated derating function protects the LEDs from overheating during high ambient temperatures.

The MAX8879 features an internally trimmed reference to set the maximum LED current. An I²C serial port is used for on/off control and setting the LED currents in 32 linear steps for main, sub/RGB, and movie. When using the RGB indicator, the I²C port provides 32k colors and programmable ramp-up/down rates. The camera flash for flash-mode operation is enabled by an active-low signal on the FSH pin. A safety timer is activated on the falling edge of FSH, which has an I²C-adjustable (programmable) period of no timer, 0.5s, 1.0s, or 2.0s (default). If the safety timer period expires, both flash and movie modes are disabled.

Applications

Cell Phones and Smartphones
PDAs, Digital Cameras, Camcorders
Displays with Up to 11 LEDs

Features

- ◆ Guaranteed 610mA Continuous Drive Capability
 - 4 LEDs at 30mA Each for Main Display
 - 3 LEDs at 30mA Each for Sub or RGB
 - 400mA Total for Flash
- ◆ 2-Wire I²C Serial Port
 - 5-Bit (32-Step) Linear Dimming
 - 32k Colors
 - Ramp-Up/Down Rates
- ◆ 92% Peak/83% Avg Efficiency (PLED/PBATT)
- ◆ Adaptive 1x/1.5x/2x Mode Switchover
- ◆ 0.3% (typ) LED Current Accuracy and Matching
- ◆ Low Input Ripple and EMI
- ◆ Low 0.1μA Shutdown Current
- ◆ Output Overvoltage Protection
- ◆ I²C Programmable Flash Safety Timer
- ◆ Thermal Derating Function Protects LEDs
- ◆ 24-Pin, 4mm x 4mm Thin QFN Package

Ordering Information

PART	TEMP RANGE	PIN-PACKAGE
MAX8879ETG+	-40°C to +85°C	24 Thin QFN 4mm x 4mm

Pin Configuration appears at end of data sheet.

+Denotes a lead-free/RoHS-compliant package.

Typical Operating Circuit

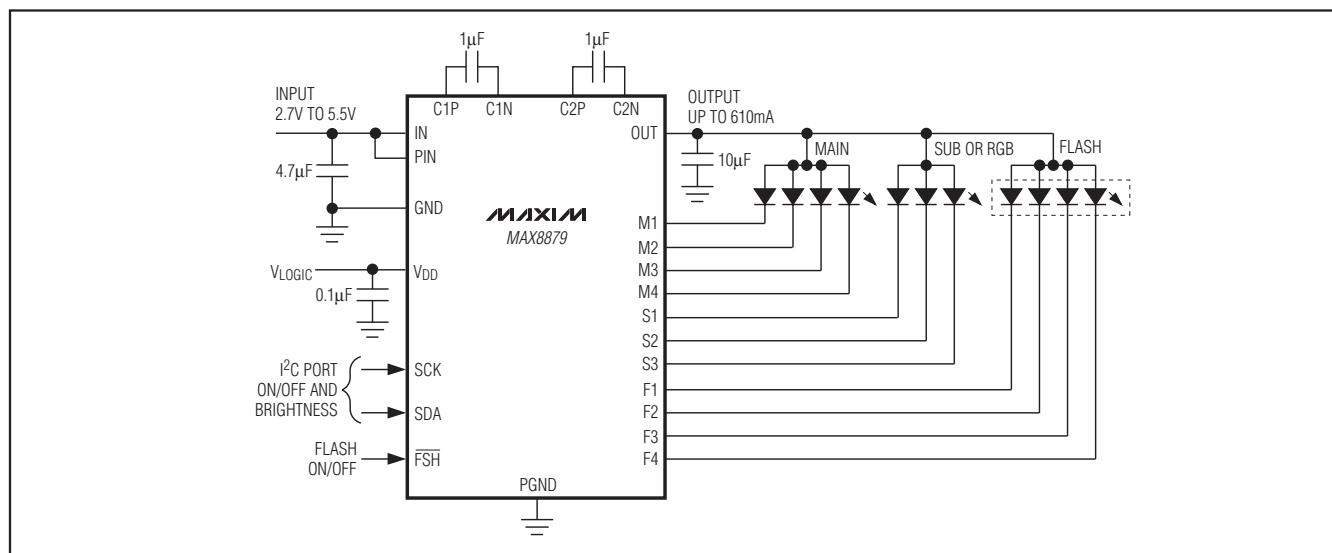

Charge Pump for Backlight/Flash/RGB LEDs with Safety Timer

ABSOLUTE MAXIMUM RATINGS

V_{DD}, I_N, P_{IN}, S_{CK}, S_{DA}, $\overline{\text{FSH}}$, O_{UT} to GND-0.3V to +6.0V
 M₋, S₋, F₋ to GND-0.3V to (V_{O_{UT}} + 0.3V)
 C1_N, C2_N to GND-0.3V to (V_{I_N} + 0.3V)
 C1_P, C2_P to GND...-0.3V to greater of (V_{O_{UT}} + 0.3V) or (V_{I_N} + 0.3V)
 P_{GND} to GND-0.3V to +0.3V
 O_{UT} Short Circuit to GNDContinuous

Continuous Power Dissipation (T_A = +70°C)

24-Pin Thin QFN (derate 20.8mW/°C above +70°C)...1666mW
 Operating Temperature Range-40°C to +85°C
 Junction Temperature+150°C
 Storage Temperature Range-65°C to +150°C
 Lead Temperature (soldering, 10s)+300°C

Stresses beyond those listed under "Absolute Maximum Ratings" may cause permanent damage to the device. These are stress ratings only, and functional operation of the device at these or any other conditions beyond those indicated in the operational sections of the specifications is not implied. Exposure to absolute maximum rating conditions for extended periods may affect device reliability.

ELECTRICAL CHARACTERISTICS

(V_{I_N} = V_{P_{IN}} = 3.6V, V_{DD} = 1.8V, V_{GND} = V_{P_{GND}} = 0V, temperature derating disabled, T_A = -40°C to +85°C, typical values are at T_A = +25°C, unless otherwise noted.) (Note 1)

PARAMETER	CONDITIONS	MIN	TYP	MAX	UNIT
IN Operating Voltage		2.7		5.5	V
V _{DD} Operating Range		1.6		5.5	V
Undervoltage-Lockout Threshold	V _{I_N} rising or falling	2.25		2.60	V
Undervoltage-Lockout Hysteresis			50		mV
Output Overvoltage-Protection Threshold	V _{O_{UT}} rising	4.75	5.00	5.25	V
IN + PIN No-Load Supply Current	1.5x or 2x mode		4.0	6.5	mA
	10% setting, 1x mode, flash off		0.35		
IN + PIN Shutdown Supply Current	All LEDs off, $\overline{\text{FSH}}$ = S _{DA} = S _{CK} = V _{DD} , I ² C ready	T _A = +25°C	0.7	5	μA
		T _A = +85°C	0.8		
V _{DD} Quiescent Current	All LEDs off, S _{DA} = S _{CK} = V _{DD} , I ² C ready	T _A = +25°C	0.1	1	μA
		T _A = +85°C	0.1		
Soft-Start Time	Startup into 1x mode		0.5		ms
	Startup into 1.5x mode		1.0		
	Startup into 2x mode		1.5		
LED Current Derating Function Start Temperature	Temperature derating enabled		+40		°C
LED Current Derating Function Slope	T _A = +40°C to +85°C, temperature derating enabled		-1.7		%/°C
LED Current SUB Output Accuracy (Note 2)	Default current setting, T _A = +25°C	-2	±0.3	+2	%
	Default current setting, T _A = -40°C to +85°C	-5		+5	
LED Current FLASH and MAIN Output Accuracy	Default current setting (Note 2)	-5	±0.3	+5	%
Maximum M ₋ , S ₋ , F ₋ Sink Current	M ₋ , S ₋	28.5	30.0		mA
	F ₋	95	100		
LED Dropout Voltage	100% LED setting (Note 3)	M ₋ , S ₋	40	90	mV
		F ₋	40	90	
1.5x and 2x Mode Regulation Voltage			150		mV
1x to 1.5x and 1.5x to 2x Mode Transition Threshold	V _M -, V _S -, V _F - falling		100		mV

Charge Pump for Backlight/Flash/RGB LEDs with Safety Timer

MAX8879

ELECTRICAL CHARACTERISTICS (continued)

($V_{IN} = V_{PIN} = 3.6V$, $V_{DD} = 1.8V$, $V_{GND} = V_{PGND} = 0V$, temperature derating disabled, $T_A = -40^{\circ}C$ to $+85^{\circ}C$, typical values are at $T_A = +25^{\circ}C$, unless otherwise noted.) (Note 1)

PARAMETER	CONDITIONS	MIN	TYP	MAX	UNIT
Input Voltage Mode Transition Hysteresis			150		mV
M_{-} , S_{-} , F_{-} Leakage in Shutdown	All LEDs off, $\overline{FSH} = V_{DD}$	$T_A = +25^{\circ}C$	0.01	1	μA
		$T_A = +85^{\circ}C$	0.1		
OUT Pulldown Resistance in Shutdown	All LEDs off, $\overline{FSH} = V_{DD}$		5		$k\Omega$
Maximum OUT Current	$V_{IN} \geq 3.2V$, $V_{OUT} = 3.9V$	610			mA
Open-Loop OUT Resistance	1x mode ($V_{IN} - V_{OUT}$) / I_{OUT}		0.5	2.5	Ω
	1.5x mode ($1.5 \times V_{IN} - V_{OUT}$) / I_{OUT}		1.5	3.5	
	2x mode ($2 \times V_{IN} - V_{OUT}$) / I_{OUT}		2.0	4.1	
Switching Frequency			1		MHz
$S1$, $S2$, $S3$ (RGB) Full-Scale Ramp Time	$SDA = 111xxx00$		2^9		μs
	$SDA = 111xxx01$		2^{18}		
	$SDA = 111xxx10$		2^{19}		
	$SDA = 111xxx11$		2^{20}		
Logic-Input High Voltage	$V_{DD} = 1.6V$ to $5.5V$	$0.7 \times V_{DD}$			V
Logic-Input Low Voltage	$V_{DD} = 1.6V$ to $5.5V$		$0.3 \times V_{DD}$		V
Logic-Input Current	$V_{IL} = 0V$ or $V_{IH} = 5.5V$	$T_A = +25^{\circ}C$	0.01	1	μA
		$T_A = +85^{\circ}C$	0.1		
SDA Output Low Voltage	$I_{SDA} = 3mA$		0.03	0.4	V
I ² C Clock Frequency				400	kHz
Bus-Free Time Between START and STOP	t_{BUF}	1.3			μs
Hold Time Repeated START Condition	t_{HD_STA}	0.6	0.1		μs
SCK Low Period	t_{LOW}	1.3	0.2		μs
SCK High Period	t_{HIGH}	0.6	0.2		μs
Setup Time Repeated START Condition	t_{SU_STA}	0.6	0.1		μs
SDA Hold Time	t_{HD_DAT}	0	-0.01		μs
SDA Setup Time	t_{SU_DAT}	100	50		ns
Setup Time for STOP Condition	t_{SU_STO}	0.6	0.1		μs
Thermal Shutdown			+160		$^{\circ}C$
Thermal-Shutdown Hysteresis			20		$^{\circ}C$

Note 1: All devices are 100% production tested at $T_A = +25^{\circ}C$. Limits over the operating temperature range are guaranteed by design.

Note 2: LED current specification includes both accuracy and matching tolerance.

Note 3: Dropout voltage is defined as the $M2$ or $F3$ to GND voltage at which current into $M2$ or $F3$ drops 10% from the value at 0.2V. All other current regulators are tested functionally by the accuracy test and guaranteed for low dropout by design.

Charge Pump for Backlight/Flash/RGB LEDs with Safety Timer

Typical Operating Characteristics

($T_A = +25^\circ\text{C}$, unless otherwise noted.)

EFFICIENCY vs. SUPPLY VOLTAGE DRIVING 4 MAIN LEDs

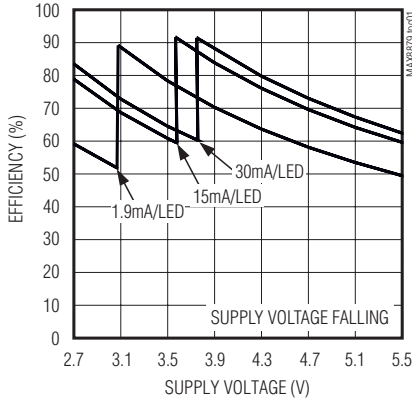

INPUT CURRENT vs. SUPPLY VOLTAGE DRIVING LUMILEDS LXCL-PWF1 FLASH

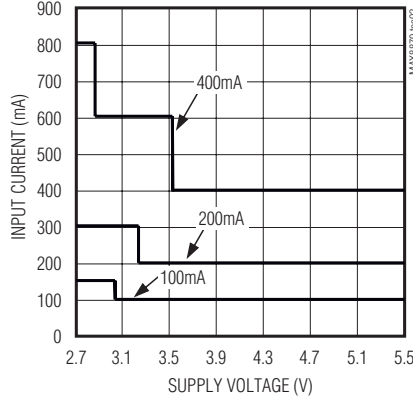

INPUT CURRENT vs. SUPPLY VOLTAGE DRIVING 4 MAIN LEDs AND RGB LEDs

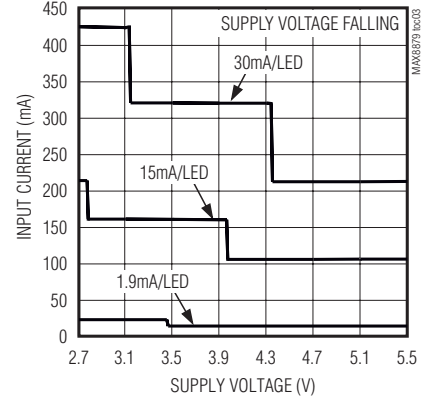

INPUT CURRENT vs. SUPPLY VOLTAGE DRIVING 4 MAIN LEDs

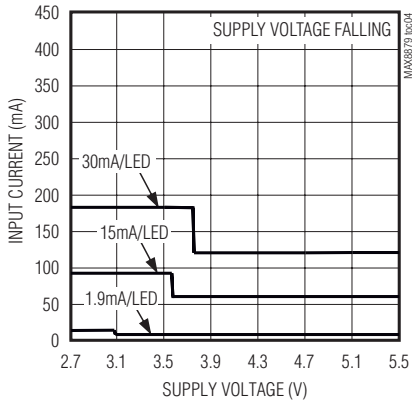

INPUT CURRENT vs. SUPPLY VOLTAGE DRIVING RGB LEDs

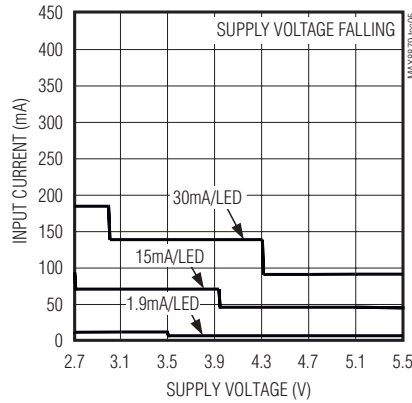

LED CURRENT MATCHING vs. SUPPLY VOLTAGE (MAIN AND RGB AT FULL CURRENT)

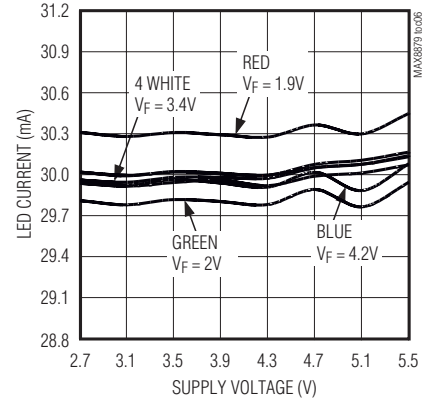

LED CURRENT MATCHING vs. SUPPLY VOLTAGE (MAIN AND RGB AT 1.9mA/LED)

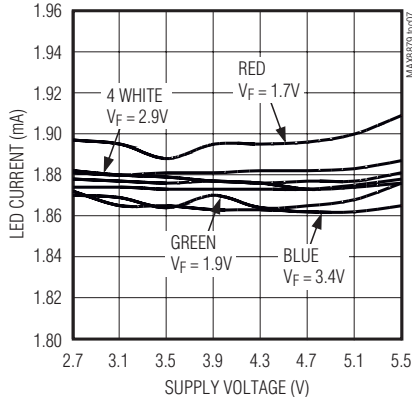

LED CURRENT vs. TEMPERATURE

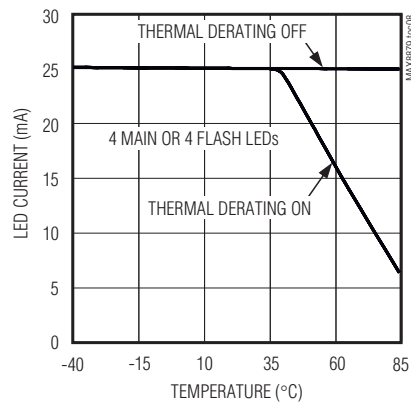

Charge Pump for Backlight/Flash/RGB LEDs with Safety Timer

Typical Operating Characteristics (continued)

($T_A = +25^\circ\text{C}$, unless otherwise noted.)

MAX8879

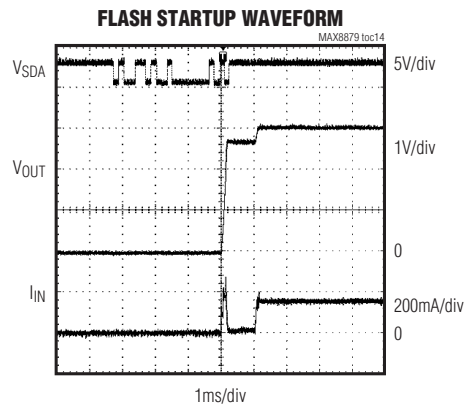
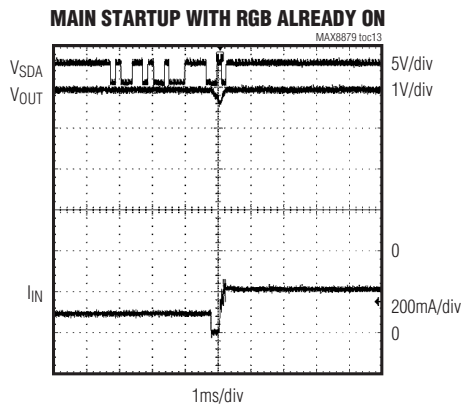
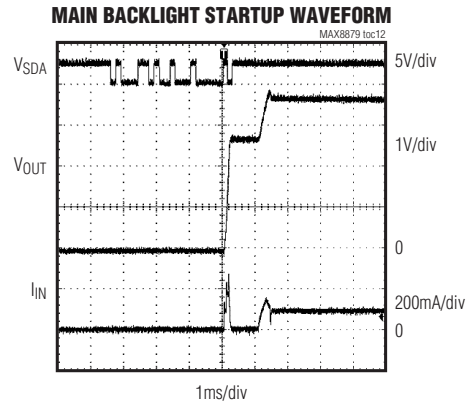
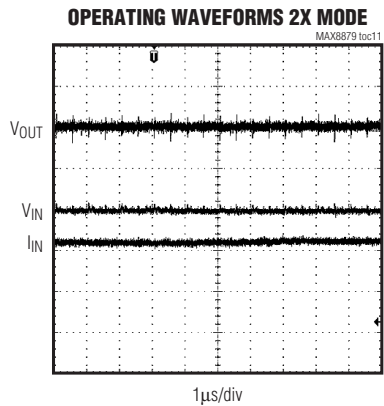
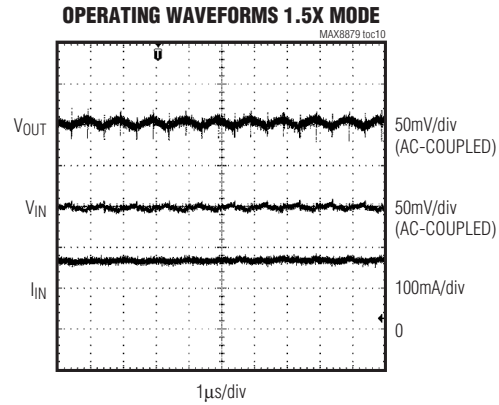
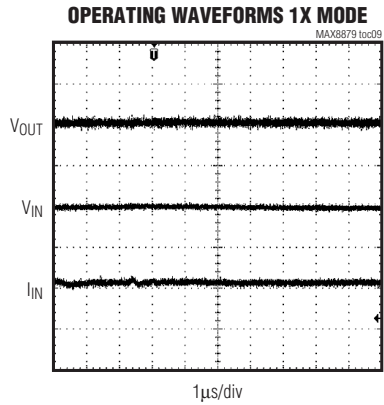

Charge Pump for Backlight/Flash/RGB LEDs with Safety Timer

Typical Operating Characteristics (continued)

($T_A = +25^\circ\text{C}$, unless otherwise noted.)

**STROBE STARTUP WAVEFORM
WITH MAIN ALREADY ON**

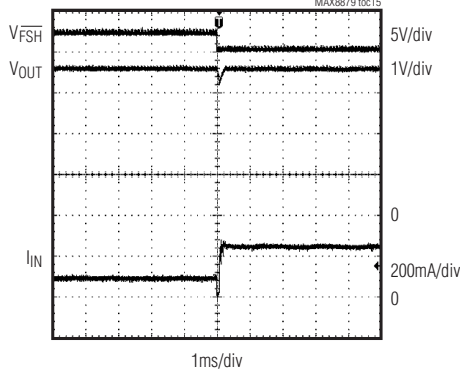

**MAIN BRIGHTNESS CHANGE
(1.9mA/LED TO 30mA/LED)**

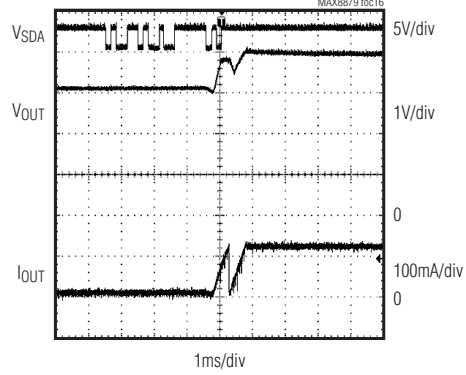

**LINE-TRANSIENT RESPONSE
(4V TO 3.3V TO 4V)**

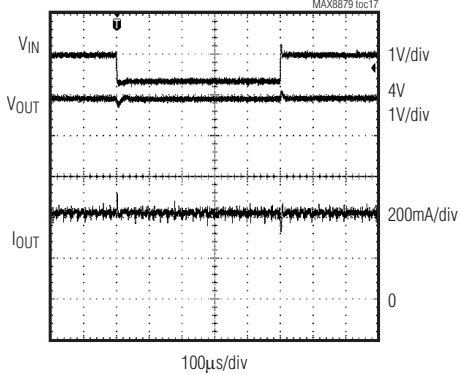

**LINE-TRANSIENT RESPONSE WITH
MODE TRANSITION (3.3V TO 2.7V TO 3.3V)**

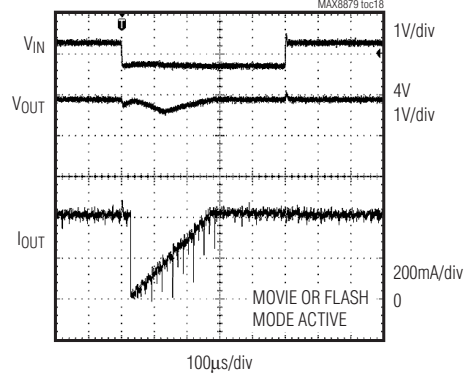

**RGB RAMP WAVEFORMS
(BLUE-TO-YELLOW TRANSITION)**

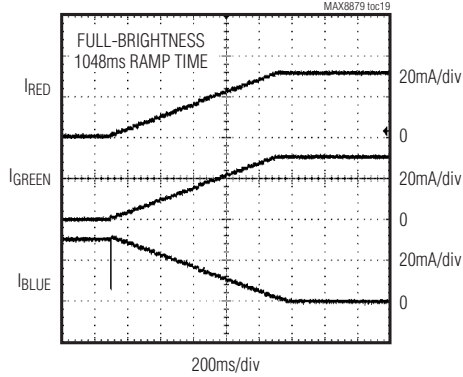

**RGB RAMP WAVEFORMS
(BLUE-TO-YELLOW TRANSITION)**

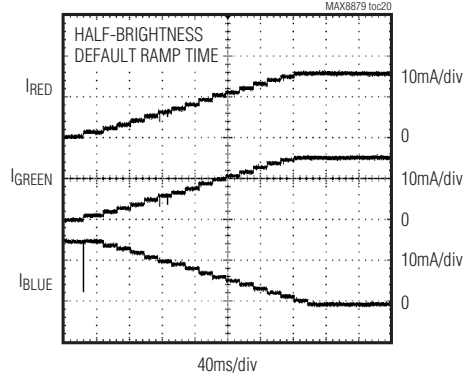

Charge Pump for Backlight/Flash/RGB LEDs with Safety Timer

Pin Description

MAX8879

PIN	NAME	FUNCTION
1	PIN	Power-Supply Voltage Input. Connect PIN to IN. Connect a 4.7 μ F ceramic capacitor from PIN to PGND. The input voltage range is 2.7V to 5.5V. PIN is high impedance during shutdown.
2	IN	Analog Supply Voltage Input. Connect IN to PIN. The input voltage range is 2.7V to 5.5V. IN is high impedance during shutdown.
3	GND	Ground. Connect GND to system ground and the ground side of the input bypass capacitor as close to the IC as possible.
4	V _{DD}	Logic-Input Supply Voltage. Connect V _{DD} to the logic supply driving SDA and SCK. Connect a 0.1 μ F ceramic capacitor from V _{DD} to GND.
5	M4	LED Cathode Connections. Current flowing into these pins is based on the internal I ² C dimming registers. The charge pump regulates the lowest LED cathode voltage to 0.15V. Grounding any of these pins forces output overvoltage protection mode causing OUT to pulse on and off at approximately 5V. To avoid constantly operating in overvoltage protection mode, any unused LED cathode connection (M ₋ , S ₋ , or F ₋) must be connected to OUT. This disables the corresponding current regulator. These pins are high impedance in shutdown. M1 through M4 are for main display backlights. S1 through S3 are for subdisplay backlights or one RGB LED indicator. F1 through F4 are for LED flash. Any combination of M ₋ , S ₋ , and F ₋ can be connected together to drive higher current LEDs.
6	M3	
7	M2	
8	M1	
9	F4	
10	F3	
11	F2	
12	F1	
13	S3	
14	S2	
15	S1	
16	$\overline{\text{FSH}}$	Flash Logic Input. Drive $\overline{\text{FSH}}$ low to turn on the flash LEDs (F1–F4) at the current specified in the internal flash register. The built-in flash timer is activated by synchronizing with the active-low falling edge on the pin. Drive $\overline{\text{FSH}}$ high to turn off the flash LEDs. This logic-high/low signal is only dedicated for enabling or deactivating flash LEDs. If the embedded flash timer expires in a certain time, it is not reactivated unless a falling edge is monitored again.
17	SCK	I ² C Clock Input. Data is read on the rising edge of SCK.
18	SDA	I ² C Data Input. Data is read on the rising edge of SCK.
19	C1N	Transfer Capacitor 1 Negative Connection. Connect a 1 μ F ceramic capacitor from C1N to C1P. C1N is shorted to IN during shutdown.
20	C1P	Transfer Capacitor 1 Positive Connection. Connect a 1 μ F ceramic capacitor from C1N to C1P. During shutdown, if V _{OUT} > V _{IN} , C1P is shorted to OUT. If V _{OUT} < V _{IN} , C1P is shorted to IN.
21	PGND	Power Ground. Charge-pump switching ground. Connect to GND and EP as close to the IC as possible.
22	OUT	Output. Connect a 10 μ F ceramic capacitor from OUT to PGND. The anodes of all the LEDs connect to OUT. OUT is pulled to ground through an internal 5k Ω resistor in shutdown.
23	C2P	Transfer Capacitor 2 Positive Connection. Connect a 1 μ F ceramic capacitor from C2N to C2P. During shutdown, if V _{OUT} > V _{IN} , C2P is shorted to OUT. If V _{OUT} < V _{IN} , C2P is shorted to IN.
24	C2N	Transfer Capacitor 2 Negative Connection. Connect a 1 μ F ceramic capacitor from C2N to C2P. C2N is shorted to IN during shutdown.
—	EP	Exposed Paddle. Connect to GND and PGND directly under the IC.

Charge Pump for Backlight/Flash/RGB LEDs with Safety Timer

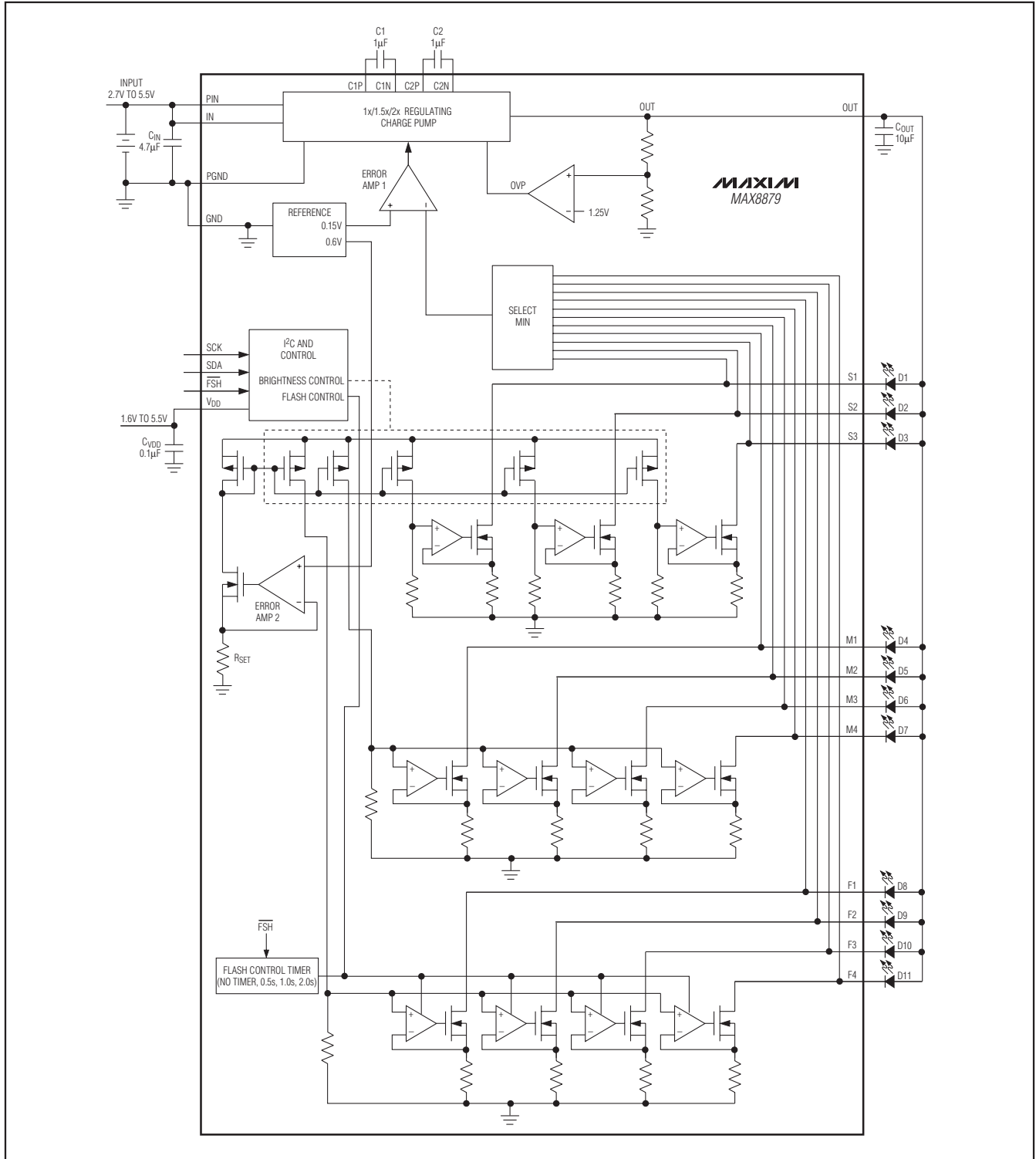

Figure 1. Functional Diagram

Charge Pump for Backlight/Flash/RGB LEDs with Safety Timer

Detailed Description

The MAX8879 charge pump operates in three modes to maintain high efficiency over a wide supply voltage range. The IC automatically selects between these three modes as described in the *1x/1.5x/2x Mode Switchover* section.

Current-sinking LED cathode connections are provided to drive four main (M₋) and three sub (S₋) LEDs at a regulated current up to 30mA each. The sub LED connections can be used for either subdisplay backlighting or one RGB indicator. The IC also contains four flash LED connections (F₋) that sink up to 100mA each. These LED connections can be connected together in any combination to provide increased current up to 610mA total.

An I²C serial port is used for on/off control and setting the LED currents in 32 linear steps. When using the RGB indicator, the I²C port provides 32k colors and programmable ramp-up/down rates. The camera flash may be turned on/off through a separate digital logic input (FSH) with the maximum flash safety timer programmed to an I²C-selectable value. The movie mode may be turned on/off only through the I²C interface. The flash and movie modes have separately adjustable brightness levels through separate I²C registers.

1x/1.5x/2x Mode Switchover

When the input voltage is higher than the required output voltage needed to drive the LEDs, the MAX8879 pulls OUT up to the input voltage (in 1x mode), while still regulating the LED current with the current regulators. As the input voltage drops, the lowest LED cathode voltage falls below the 100mV switchover

threshold, and the MAX8879 starts switching in 1.5x mode. When the input voltage is rising, the transition from 1.5x to 1x is made when V_{IN} is greater than V_{OUT}.

When the MAX8879 is running in 1.5x mode and the input voltage is decreased, the lowest LED cathode voltage crosses the 100mV switchover threshold again. At this point, the MAX8879 changes to the 2x charge-pump mode. With the input voltage rising and the MAX8879 in 2x mode, the IC changes to 1.5x mode once V_{IN} is greater than 2/3 of the output voltage.

Soft-Start

The MAX8879 includes soft-start circuitry to limit inrush current at turn-on and mode transitions. When starting up, the output capacitor is charged directly from the input with a ramped current source (with no charge-pump action) until the output voltage is near the input voltage. After 512μs, if all the LED cathodes are not above 100mV, the MAX8879 switches to 1.5x mode with the LED output current ramped from 1/32 to the programmed current in 1/32 steps. After another 512μs, if all the LED cathodes are not above 100mV, the MAX8879 switches to 2x mode, once again ramping the LED current from 1/32 to the programmed current in 1/32 steps. Any time the output voltage is less than 1.25V, the soft-start routine is reset to the 1x state. Thus, the startup time is 512μs, 1024μs, or 1536μs, depending on what mode is required after the completion of startup.

Output-Current Settings

The output currents for the main, sub, and flash current regulators are set using the I²C serial interface (see the *I²C Interface* section). The current for the four main LEDs is always equal and set with a single command.

Table 1. Control Data Byte

FUNCTION	SDA CONTROL BYTE							
	COMMAND			DATA				
	C2	C1	C0	D4	D3	D2	D1	D0
On/Off Control	0	0	0	Main	Sub3	Sub2	Sub1	Movie
Main Brightness	0	0	1	32-steps, 30mA/LED max				
Sub1 Brightness	0	1	0	32-steps, 30mA max				
Sub2 Brightness	0	1	1	32-steps, 30mA max				
Sub3 Brightness	1	0	0	32-steps, 30mA max				
Movie Brightness	1	0	1	16-steps, 51.0mA/LED max, I ² C enable				
Flash Brightness	1	1	0	32-steps, 100mA/LED max, active-low enable on FSH				
Other Functions	1	1	1	Flash-on time No timer (00), 0.5s (01), 1.0s (10), 2.0s (11)		Temp derate		RGB ramp rate

Notes: C2 is MSB and D0 is LSB. Default in **bold italics**.

Charge Pump for Backlight/Flash/RGB LEDs with Safety Timer

Table 2. Data and LED Currents

DATA					LED CURRENT (mA)					
D4	D3	D2	D1	D0	MAIN	SUB1	SUB2	SUB3	MOVIE	FLASH
0	0	0	0	0	0.9	0.9	0.9	0.9	3.3	3.3
0	0	0	0	1	1.9	1.9	1.9	1.9	6.5	6.5
0	0	0	1	0	2.8	2.8	2.8	2.8	9.7	9.7
0	0	0	1	1	3.8	3.8	3.8	3.8	12.9	12.9
0	0	1	0	0	4.7	4.7	4.7	4.7	16.2	16.2
0	0	1	0	1	5.6	5.6	5.6	5.6	19.4	19.4
0	0	1	1	0	6.6	6.6	6.6	6.6	22.6	22.6
0	0	1	1	1	7.5	7.5	7.5	7.5	25.8	25.8
0	1	0	0	0	8.4	8.4	8.4	8.4	28.9	28.9
0	1	0	0	1	9.4	9.4	9.4	9.4	32.1	32.1
0	1	0	1	0	10.3	10.3	10.3	10.3	35.4	35.4
0	1	0	1	1	11.3	11.3	11.3	11.3	38.6	38.6
0	1	1	0	0	12.2	12.2	12.2	12.2	41.6	41.6
0	1	1	0	1	13.1	13.1	13.1	13.1	44.7	44.7
0	1	1	1	0	14.1	14.1	14.1	14.1	47.9	47.9
0	1	1	1	1	15.0	15.0	15.0	15.0	51.0	51.0
1	0	0	0	0	15.9	15.9	15.9	15.9	3.3	54.1
1	0	0	0	1	16.9	16.9	16.9	16.9	6.5	57.2
1	0	0	1	0	17.8	17.8	17.8	17.8	9.7	60.3
1	0	0	1	1	18.8	18.8	18.8	18.8	12.9	63.4
1	0	1	0	0	19.7	19.7	19.7	19.7	16.2	66.3
1	0	1	0	1	20.6	20.6	20.6	20.6	19.4	69.6
1	0	1	1	0	21.6	21.6	21.6	21.6	22.6	72.7
1	0	1	1	1	22.5	22.5	22.5	22.5	25.8	75.8
1	1	0	0	0	23.4	23.4	23.4	23.4	28.9	78.8
1	1	0	0	1	24.4	24.4	24.4	24.4	32.1	81.9
1	1	0	1	0	25.3	25.3	25.3	25.3	35.4	84.9
1	1	0	1	1	26.3	26.3	26.3	26.3	38.6	87.9
1	1	1	0	0	27.2	27.2	27.2	27.2	41.6	91.0
1	1	1	0	1	28.1	28.1	28.1	28.1	44.7	94.0
1	1	1	1	0	29.1	29.1	29.1	29.1	47.9	97.0
1	1	1	1	1	30.0	30.0	30.0	30.0	51.0	100.0

Note: Defaults in **bold italics**.

Charge Pump for Backlight/Flash/RGB LEDs with Safety Timer

MAX8879

Table 3. Control Data Byte (Hexadecimal)

CONTROL BYTE (HEXADECIMAL)						LED CURRENT (mA)					
MAIN	SUB1	SUB2	SUB3	MOVIE	FLASH	MAIN	SUB1	SUB2	SUB3	MOVIE	FLASH
20	40	60	80	A0	C0	0.9	0.9	0.9	0.9	3.3	3.3
21	41	61	81	A1	C1	1.9	1.9	1.9	1.9	6.5	6.5
22	42	62	82	A2	C2	2.8	2.8	2.8	2.8	9.7	9.7
23	43	63	83	A3	C3	3.8	3.8	3.8	3.8	12.9	12.9
24	44	64	84	A4	C4	4.7	4.7	4.7	4.7	16.2	16.2
25	45	65	85	A5	C5	5.6	5.6	5.6	5.6	19.4	19.4
26	46	66	86	A6	C6	6.6	6.6	6.6	6.6	22.6	22.6
27	47	67	87	A7	C7	7.5	7.5	7.5	7.5	25.8	25.8
28	48	68	88	A8	C8	8.4	8.4	8.4	8.4	28.9	28.9
29	49	69	89	A9	C9	9.4	9.4	9.4	9.4	32.1	32.1
2A	4A	6A	8A	AA	CA	10.3	10.3	10.3	10.3	35.4	35.4
2B	4B	6B	8B	AB	CB	11.3	11.3	11.3	11.3	38.6	38.6
2C	4C	6C	8C	AC	CC	12.2	12.2	12.2	12.2	41.6	41.6
2D	4D	6D	8D	AD	CD	13.1	13.1	13.1	13.1	44.7	44.7
2E	4E	6E	8E	AE	CE	14.1	14.1	14.1	14.1	47.9	47.9
2F	4F	6F	8F	AF	CF	15.0	15.0	15.0	15.0	51.0	51.0
30	50	70	90	B0	D0	15.9	15.9	15.9	15.9	3.3	54.1
31	51	71	91	B1	D1	16.9	16.9	16.9	16.9	6.5	57.2
32	52	72	92	B2	D2	17.8	17.8	17.8	17.8	9.7	60.3
33	53	73	93	B3	D3	18.8	18.8	18.8	18.8	12.9	63.4
34	54	74	94	B4	D4	19.7	19.7	19.7	19.7	16.2	66.3
35	55	75	95	B5	D5	20.6	20.6	20.6	20.6	19.4	69.6
36	56	76	96	B6	D6	21.6	21.6	21.6	21.6	22.6	72.7
37	57	77	97	B7	D7	22.5	22.5	22.5	22.5	25.8	75.8
38	58	78	98	B8	D8	23.4	23.4	23.4	23.4	28.9	78.8
39	59	79	99	B9	D9	24.4	24.4	24.4	24.4	32.1	81.9
3A	5A	7A	9A	BA	DA	25.3	25.3	25.3	25.3	35.4	84.9
3B	5B	7B	9B	BB	DB	26.3	26.3	26.3	26.3	38.6	87.9
3C	5C	7C	9C	BC	DC	27.2	27.2	27.2	27.2	41.6	91.0
3D	5D	7D	9D	BD	DD	28.1	28.1	28.1	28.1	44.7	94.0
3E	5E	7E	9E	BE	DE	29.1	29.1	29.1	29.1	47.9	97.0
3F	5F	7F	9F	BF	DF	30.0	30.0	30.0	30.0	51.0	100.0

Note: Defaults in **bold italics**.

Charge Pump for Backlight/Flash/RGB LEDs with Safety Timer

Table 4. RGB Ramp Rate

CONTROL BYTE (HEXADECIMAL)	RGB RAMP RATE (A/s)	RAMP TIME FROM OFF TO FULL BRIGHTNESS (ms)
E0	58.6	0.512
E1	0.114	262
E2	0.0572	524
E3	0.0286	1048

*Default in **bold italics**.

The currents for the three sub LEDs are set independently, allowing them to drive an RGB LED. The current-level settings for both the main and sub LEDs range from 0.9mA to 30mA, defaulting to 15mA each (see Tables 1, 2, and 3).

The flash LEDs are controlled by pulsing the $\overline{\text{FSH}}$ input low. There are two registers in the MAX8879 to set the flash/movie current level. The Movie register sets the F1–F4 LED current when the I²C interface is used to activate the LEDs and the Flash register sets the F1–F4 LED current when the $\overline{\text{FSH}}$ input is pulsed low. The current level settings for the flash LEDs ranges from 3.3mA to 100mA, with a default of 25.8mA (see Tables 1, 2, and 3). The Flash register has priority over the Movie register when both movie and flash are on. In the event that the flash safety timer period expires, the flash LEDs are turned off and the movie mode ON/OFF control bit is reset to 0. This is to prevent the MAX8879 from going back into movie mode in the event of a safety timer violation.

The LED cathode connections (M₋, S₋, and F₋) can be connected together in any combination to allow the use of higher current LEDs. For example, to drive a single flash LED at up to 400mA, connect F1, F2, F3, and F4 together to the cathode of the flash LED.

To avoid constantly operating in overvoltage protection mode, any unused LED cathode connection (M₋, S₋, or F₋) must be connected to OUT. This disables the corresponding current regulator.

RGB Color and Ramp-Rate Settings

The three sub LED currents are controlled independently by the I²C interface, allowing for use of a common anode RGB LED. Thirty-two programmable brightness levels (5 bits) per LED provide a total of 32k colors. To smooth the transition between different color/brightness settings, a controlled ramp is used when the sub LED current level is changed, when the sub LEDs are enabled, and when the LEDs are disabled. The ramp rate is set to one of four settings with the I²C interface (see Table 4).

Temperature-Derating Function

The MAX8879 contains a temperature-derating function that automatically limits the LED current at high temperatures in accordance with the recommended derating curve of popular white LEDs. The derating function enables the safe usage of higher LED current at room temperature, thus reducing the number of LEDs required to backlight the display. In camera-light applications, the derating circuit protects the LEDs and PC board from overheating. The derating circuit limits the LED current

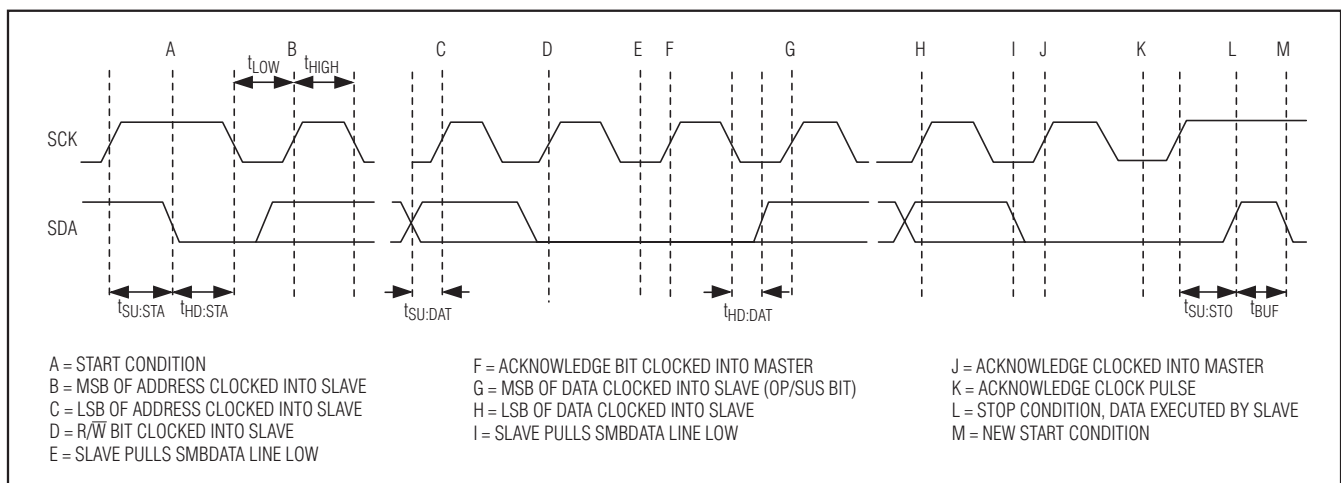

Figure 2. I²C Timing Diagram

Charge Pump for Backlight/Flash/RGB LEDs with Safety Timer

by reducing the LED current above +40°C by approximately 1.7%/°C. The typical derating function characteristic is shown in the *Typical Operating Characteristics*. The temperature derating function is enabled/disabled using the I²C interface and is off by default.

I²C Interface

An I²C 2-wire serial interface is provided on the MAX8879 to control LED brightness, flash, temperature deration, and RGB ramp rate. The serial interface consists of a serial data line (SDA) and a serial clock line (SCK). Standard I²C write-byte commands are used. Figure 2 shows a timing diagram for the I²C protocol. The MAX8879 is a slave-only device, relying upon a master to generate a clock signal. The master (typically a microprocessor) initiates data transfer on the bus and generates SCK to permit data transfer. A master device communicates to the MAX8879 by transmitting the proper 8-bit address (0x9A) followed by the 8-bit control byte. Each 8-bit control byte consists of a 3-bit command code and 5 bits of data (see Table 1). Each transmit sequence is framed by a START (A) condition and a STOP (L) condition (see Figure 2). Each word transmitted over the bus is 8 bits long and is always followed by an acknowledge clock pulse.

Shutdown Mode

When all the LEDs are off, the MAX8879 turns off the charge pump and enters low-power shutdown mode. When in shutdown, OUT is pulled to GND by an internal 5kΩ resistor, discharging the output capacitor. IN and PIN are high impedance during shutdown, but the I²C interface (powered from V_{DD}) remains active. To enter shutdown, send control byte 0x00 to the I²C interface, and drive FSH high. To exit shutdown, enable any of the LEDs with the I²C interface.

FSH Logic Input

The FSH input is used to control the flash LEDs with the embedded safety timer. When FSH is driven low, the flash LEDs are driven to the current set in the Flash register. Driving FSH low activates the flash safety timer with the pre-set time (programmed period). The safety timer is not activated until an active-low signal is applied to FSH. This function also serves as a protection feature to avoid thermal damage to the flash LEDs because of software-related errors. This pin is the flash-dedicated control pin.

Movie-Mode Operation

The movie current level is set through the I²C interface according to the current scale in Movie register. The ON/OFF of movie LEDs is only through I²C interface.

Output Overvoltage Protection

In case an LED fails or the cathode is shorted to GND, the output overvoltage protection limits the output to 5V. When the MAX8879 detects the output voltage rising above 5V, it shuts off the charge pump. The charge pump restarts once the output voltage has dropped to 4.9V.

To avoid constantly operating in overvoltage protection, any unused LED cathode connection (M₋, S₋, or F₋) must be connected to OUT; this disables the corresponding current regulator.

Thermal Shutdown

Thermal shutdown limits total power dissipation in the MAX8879. When the junction temperature exceeds +160°C, the MAX8879 turns off, allowing the IC to cool. The MAX8879 turns on and begins soft-start after the junction temperature cools by 20°C. This results in a pulsed output during continuous thermal-overload conditions.

Applications Information

Input Ripple

In 1x mode, the input ripple of the MAX8879 is negligible. When the charge pump is switching in 1.5x or 2x mode, the input ripple depends on the load current and the output impedance of the source supply. The worst-case ripple occurs when the charge pump is operating in 1.5x mode. The switching waveforms in the *Typical Operating Characteristics* show the typical input ripple. For noise-sensitive applications, input ripple can be reduced by increasing the input capacitance.

Capacitor Selection

Ceramic capacitors are recommended due to their small size, low cost, and low ESR. Select ceramic capacitors that maintain their capacitance over temperature and DC bias. Capacitors with X5R or X7R temperature characteristics generally perform well. Recommended values are shown in the *Typical Operating Circuit*. Using a larger-value input capacitor helps to reduce input ripple (see the *Input Ripple* section).

PCB Layout and Routing

The MAX8879 is a high-frequency switched-capacitor regulator. For best circuit performance, use a solid ground plane and place the capacitors as close to the IC as possible. Connect the exposed pad to GND and PGND, and allow sufficient copper area for cooling the IC. Refer to the MAX8879 evaluation kit for an example PCB layout.

Charge Pump for Backlight/Flash/RGB LEDs with Safety Timer

Pin Configuration

Chip Information

PROCESS: BiCMOS

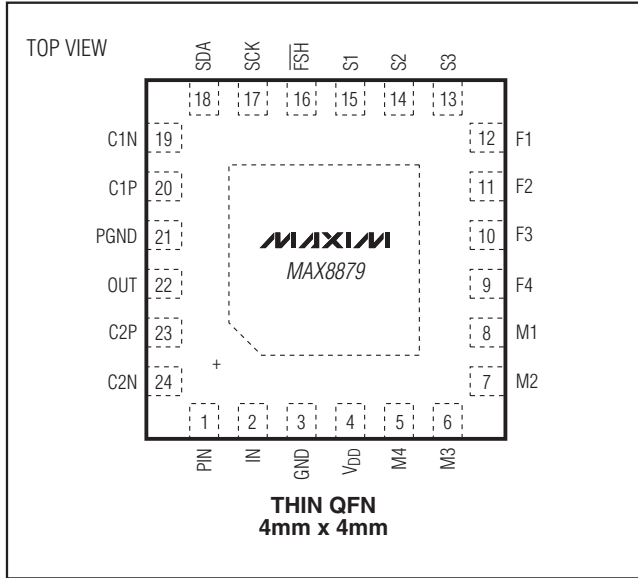

Charge Pump for Backlight/Flash/RGB LEDs with Safety Timer

Package Information

For the latest package outline information and land patterns, go to www.maxim-ic.com/packages.

PACKAGE TYPE	PACKAGE CODE	DOCUMENT NO.
8 TQFN	T2444-4	21-0139

MAX8879

24L QFN THIN.EPS

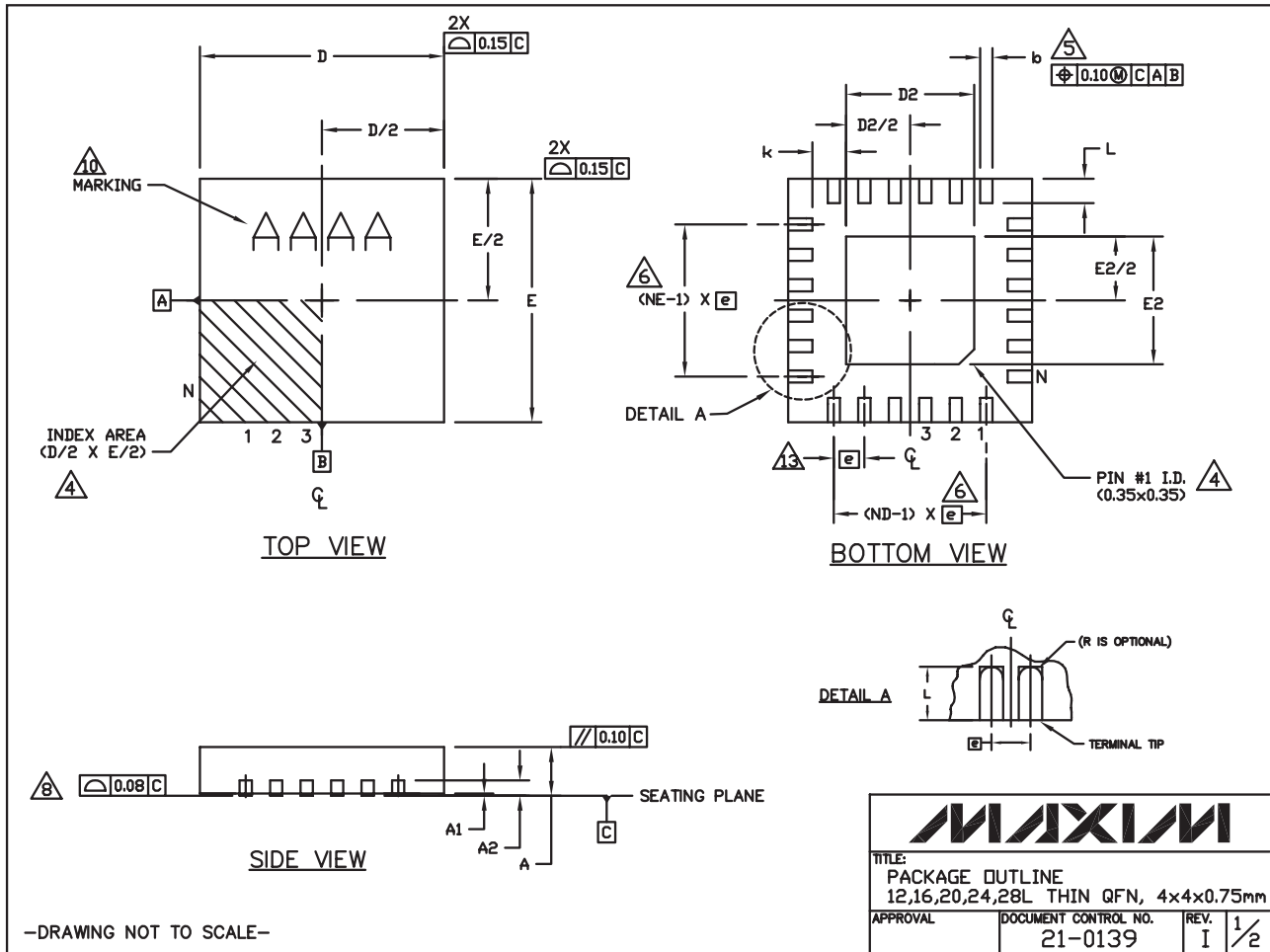

Charge Pump for Backlight/Flash/RGB LEDs with Safety Timer

Package Information (continued)

For the latest package outline information and land patterns, go to www.maxim-ic.com/packages.

COMMON DIMENSIONS															
PKG	12L 4x4			16L 4x4			20L 4x4			24L 4x4			28L 4x4		
REF.	MIN.	NDM.	MAX.	MIN.	NDM.	MAX.	MIN.	NDM.	MAX.	MIN.	NDM.	MAX.	MIN.	NDM.	MAX.
A	0.70	0.75	0.80	0.70	0.75	0.80	0.70	0.75	0.80	0.70	0.75	0.80	0.70	0.75	0.80
A1	0.0	0.02	0.05	0.0	0.02	0.05	0.0	0.02	0.05	0.0	0.02	0.05	0.0	0.02	0.05
A2	0.20 REF			0.20 REF			0.20 REF			0.20 REF			0.20 REF		
b	0.25	0.30	0.35	0.25	0.30	0.35	0.20	0.25	0.30	0.18	0.23	0.30	0.15	0.20	0.25
D	3.90	4.00	4.10	3.90	4.00	4.10	3.90	4.00	4.10	3.90	4.00	4.10	3.90	4.00	4.10
E	3.90	4.00	4.10	3.90	4.00	4.10	3.90	4.00	4.10	3.90	4.00	4.10	3.90	4.00	4.10
e	0.80 BSC.			0.65 BSC.			0.50 BSC.			0.50 BSC.			0.40 BSC.		
k	0.25	-	-	0.25	-	-	0.25	-	-	0.25	-	-	0.25	-	-
L	0.45	0.55	0.65	0.45	0.55	0.65	0.45	0.55	0.65	0.30	0.40	0.50	0.30	0.40	0.50
N	12			16			20			24			28		
ND	3			4			5			6			7		
NE	3			4			5			6			7		
JeDEC Var.	WGGB			WGGC			WGGD-1			WGGD-2			WGGE		

EXPOSED PAD VARIATIONS						
PKG. CODES	D2			E2		
	MIN.	NDM.	MAX.	MIN.	NDM.	MAX.
T1244-3	1.95	2.10	2.25	1.95	2.10	2.25
T1244-4	1.95	2.10	2.25	1.95	2.10	2.25
T1644-3	1.95	2.10	2.25	1.95	2.10	2.25
T1644-4	1.95	2.10	2.25	1.95	2.10	2.25
T2044-2	1.95	2.10	2.25	1.95	2.10	2.25
T2044-3	1.95	2.10	2.25	1.95	2.10	2.25
T2444-2	1.95	2.10	2.25	1.95	2.10	2.25
T2444-3	2.45	2.60	2.63	2.45	2.60	2.63
T2444-4	2.45	2.60	2.63	2.45	2.60	2.63
T2444N-4	2.45	2.60	2.63	2.45	2.60	2.63
T2444M-1	2.45	2.60	2.63	2.45	2.60	2.63
T2844-1	2.50	2.60	2.70	2.50	2.60	2.70

NOTES:

- DIMENSIONING & TOLERANCING CONFORM TO ASME Y14.5M-1994.
- ALL DIMENSIONS ARE IN MILLIMETERS. ANGLES ARE IN DEGREES.
- N IS THE TOTAL NUMBER OF TERMINALS.
- THE TERMINAL #1 IDENTIFIER AND TERMINAL NUMBERING CONVENTION SHALL CONFORM TO JESD 95-1 SPP-012. DETAILS OF TERMINAL #1 IDENTIFIER ARE OPTIONAL, BUT MUST BE LOCATED WITHIN THE ZONE INDICATED. THE TERMINAL #1 IDENTIFIER MAY BE EITHER A MOLD OR MARKED FEATURE.
- DIMENSION b APPLIES TO METALLIZED TERMINAL AND IS MEASURED BETWEEN 0.25mm AND 0.30mm FROM TERMINAL TIP.
- ND AND NE REFER TO THE NUMBER OF TERMINALS ON EACH D AND E SIDE RESPECTIVELY.
- DEPOPULATION IS POSSIBLE IN A SYMMETRICAL FASHION.
- COPLANARITY APPLIES TO THE EXPOSED HEAT SINK SLUG AS WELL AS THE TERMINALS.
- DRAWING CONFORMS TO JEDEC MO220, EXCEPT FOR T2444-3, T2444-4 AND T2844-1.
- MARKING IS FOR PACKAGE ORIENTATION REFERENCE ONLY.
- COPLANARITY SHALL NOT EXCEED 0.08mm.
- WARPAGE SHALL NOT EXCEED 0.10mm.
- LEAD CENTERLINES TO BE AT TRUE POSITION AS DEFINED BY BASIC DIMENSION 'e', ±0.05.
- NUMBER OF LEADS SHOWN ARE FOR REFERENCE ONLY.
- ALL DIMENSIONS ARE THE SAME FOR LEADED (-) & PbFREE (+) PACKAGE CODES.

—DRAWING NOT TO SCALE—

TITLE: PACKAGE OUTLINE 12,16,20,24,28L THIN QFN, 4x4x0.75mm			
APPROVAL	DOCUMENT CONTROL NO. 21-0139	REV. I	2/2

Maxim cannot assume responsibility for use of any circuitry other than circuitry entirely embodied in a Maxim product. No circuit patent licenses are implied. Maxim reserves the right to change the circuitry and specifications without notice at any time.

16 **Maxim Integrated Products, 120 San Gabriel Drive, Sunnyvale, CA 94086 408-737-7600**