

Bit Slave Units with Compact Connectors

CRT1B-□D02JS(-1)/□D04JS(-1)

Bit slave of smallest class in industry Innovation in wiring for any type of machinery

- Available in 2 types: 2-point Bit Slave Unit and 4-point Bit Slave Unit.
- Compact size for installation in limited space. Save space and wiring since bit slave can be installed near I/O devices.
- Industry first bit slave connectable with round cables which can be easily purchased at a lower price. Connectable with flat cables, too for easy wiring. Cables are selectable depending on applications.



NEW

Ordering Information

Name	Specifications			Model
Compact Connectors	Inputs	2 inputs	NPN	CRT1B-ID02JS NEW
		2 outputs	PNP	CRT1B-ID02JS-1 NEW
	Outputs	2 inputs	NPN	CRT1B-OD02JS NEW
		2 outputs	PNP	CRT1B-OD02JS-1 NEW
	Inputs/Outputs	1 input/1 output	NPN	CRT1B-MD02JS NEW
		1 input/1 output	PNP	CRT1B-MD02JS-1 NEW
	Inputs	4 inputs	NPN	CRT1B-ID04JS NEW
		4 outputs	PNP	CRT1B-ID04JS-1 NEW
	Outputs	4 inputs	NPN	CRT1B-OD04JS NEW
		4 outputs	PNP	CRT1B-OD04JS-1 NEW
	Inputs/Outputs	2 inputs/2 outputs	NPN	CRT1B-MD04JS NEW
		2 inputs/2 outputs	PNP	CRT1B-MD04JS-1 NEW
	Mounting Bracket			CRT1-ATT03 NEW

● Peripheral Devices

For Round Cable I

Name	Model
Open Type Connector (for Unit connection) (Honda Tsushin Kogyo Co.,Ltd.)	HCN-TB4LMZG+ *1
Terminating Resistor	DRS1-T

For Round Cable II

Name	Model
Open Type Connector (for Unit connection) (Honda Tsushin Kogyo Co.,Ltd.)	HCN-TB4LMZG+ *1
Terminating Resistor	DCN4-TM4 *2
Flat Connector Socket	DCN4-TR4 *2

Note: The DCN4-MD4 Multidrop Connector cannot be used with Bit Slaves with Compact Connectors. The Bit Slave with Compact connectors use Open Type Connectors from Honda Tsushin Kogyo Co., Ltd.

For Flat Cable I

Name	Model
Flat Connector Socket	DCN4-TR4 *2
Flat Connector Plug	DCN4-BR4 *2
Flat Multidrop Connector Plug	DCN4-MR4 *2 NEW
Terminating Resistor	DCN4-TM4 *2
Special Tools	DWT-A01

Note: The DCN4-MD4 Multidrop Connector cannot be used with Bit Slaves with Compact Connectors.

For Flat Cable II

Name	Model
Flat Connector Socket	DCN5-TR4 *2
Flat Connector Plug	DCN5-BR4 *2
Terminating Resistor	DCN5-TM4 *2
Special Tools	DWT-A02

*1 For information of HCN-TB4LMZG+, contact to Honda Tsushin Kogyo Co.,Ltd. Tel:+81-52-242-2111

*2 The minimum quantity packaged is 10 Connectors.Oder the Connectors in multiples of 10.

● Compact Connectors

The compact connectors use XA-series Connectors from JST Mfg. Co., Ltd. Special cable connectors must be attached for cables connecting to external devices if a Slave Unit with Compact Connectors is used.

Name	Applicable cable range			Model	Crimping Tool
	mm ²	AWG#	Wire sheath external diameter		
Contacts	0.08 to 0.33	28 to 22	1.2 to 1.9	SXA-001T-P0.6	YC692 or YC692R
	0.22 to 0.5	24 to 20	1.5 to 1.9	SXA-01T-P0.6	YRS701 to YC701R
Housing	---			XAP-03V-1	---

Note 1. Automated Crimp Tools are also available. For details, contact the manufacturer.

2. For information on the processing procedure, refer to the instruction manual included with the tool or contact the manufacturer (JST Mfg. Co., Ltd.).

Performance Specifications

For Basic Performance Specifications of Slave Units, refer to page 26.

Input Section Specifications

Item	Specification			
	CRT1B-ID02JS	CRT1B-ID02JS-1	CRT1B-ID04JS	CRT1B-ID04JS-1
Model	CRT1B-ID02JS	CRT1B-ID02JS-1	CRT1B-ID04JS	CRT1B-ID04JS-1
I/O capacity	2 inputs		4 inputs	
Internal I/O common	NPN	PNP	NPN	PNP
ON voltage	10.5 VDC min. (between each input terminal and the V terminal)	10.5 VDC min. (between each input terminal and the G terminal)	10.5 VDC min. (between each input terminal and the V terminal)	10.5 VDC min. (between each input terminal and the G terminal)
OFF voltage	---	---	---	---
OFF current	1.0 mA max.		1.0 mA max.	
Input current	3.0 mA min./input (at 10.5 VDC)		3.0 mA min./input (at 10.5 VDC)	
Sensor power supply voltage	Communications power supply voltage 0 V (max.) Communications power supply voltage -1 V (min.)		Communications power supply voltage 0 V (max.) Communications power supply voltage -1 V (min.)	
ON delay	1.5 ms max.		1.5 ms max.	
OFF delay	1.5 ms max.		1.5 ms max.	
Number of circuits per common	2 inputs/common		4 inputs/common	
Power short-circuit detection	Not supported.		Not supported.	
Isolation method	No isolation		No isolation	
Input indicators	LEDs (yellow)		LEDs (yellow)	
Degree of protection	IEC standard IP20		IEC standard IP20	
Installation	M4 screw mounting using CRT1B-ATT03 Mounting Bracket		M4 screw mounting using CRT1B-ATT03 Mounting Bracket	
Power supply type	Network power supply		Network power supply	
Communications power supply current consumption (See note.)	25 mA max. for 24-VDC power supply voltage 30 mA max. for 14-VDC power supply voltage		35 mA max. for 24-VDC power supply voltage 40 mA max. for 14-VDC power supply voltage	
Input device supply current	50 mA/point (G terminal)	50 mA/point (V terminal)	50 mA/point (G terminal)	50 mA/point (V terminal)
Weight	16 g max.		21 g max.	

Note: The current consumption is for Bit Slave Unit communications current when all inputs are OFF, i.e., it does not include input device current consumption. The communications power supply is also used for the I/O power supply for sensors. Be sure to consider the sensor current consumption and the number of sensors connected in addition to the communications power.

The power supply current consumption is expressed by the following formula.

$$\text{Communications power supply current consumption} = \text{Bit Slave Unit communications current consumption} + (\text{Bit Slave Unit input current} \times \text{number of inputs used}) + (\text{sensor current consumption} \times \text{number of sensors used})$$

Output Section Specifications

Item	Specification			
Model	CRT1B-OD02JS	CRT1B-OD02JS-1	CRT1B-OD04JS	CRT1B-OD04JS-1
I/O capacity	2 outputs		4 outputs	
Internal I/O common	NPN	PNP	NPN	PNP
ON voltage	0.1 A/output		0.1 A/output	
OFF voltage	Communications power supply voltage 0 V (max.) Communications power supply voltage -1.2 V (min.)		Communications power supply voltage 0 V (max.) Communications power supply voltage -1.2 V (min.)	
OFF current	1.2 V max. (0.1 A DC, between each output terminal and G terminal)	1.2 V max. (0.1 A DC, between each output terminal and V terminal)	1.2 V max. (0.1 A DC, between each output terminal and G terminal)	1.2 V max. (0.1 A DC, between each output terminal and V terminal)
Input current	0.1 mA max.		0.1 mA max.	
Sensor power supply voltage	0.5 ms max.		0.5 ms max.	
ON delay	1.5 ms max.		1.5 ms max.	
OFF delay	2 outputs/common		4 outputs/common	
Number of circuits per common	Not supported.		Not supported.	
Power short-circuit detection	No isolation		No isolation	
Isolation method	LEDs (yellow)		LEDs (yellow)	
Input indicators	IEC standard IP20		IEC standard IP20	
Degree of protection	M4 screw mounting using CRT1B-ATT03 Mounting Bracket		M4 screw mounting using CRT1B-ATT03 Mounting Bracket	
Installation	Network power supply		Network power supply	
Power supply type	25 mA max. for 24-VDC power supply voltage 30 mA max. for 14-VDC power supply voltage		30 mA max. for 24-VDC power supply voltage 35 mA max. for 14-VDC power supply voltage	
Communications power supply current consumption (See note.)	30 mA/point (G terminal)	30 mA/point (V terminal)	30 mA/point (G terminal)	30 mA/point (V terminal)
Input device supply current	16 g max.		21 g max.	
Weight	Specification		CRT1B-OD04JS	CRT1B-OD04JS-1

Note: The current consumption is for Bit Slave Unit communications current when all outputs are OFF, i.e., it does not include the output device load current consumption. The communications power supply is also used for the I/O power supply for actuators. Be sure to consider the actuator load current consumption and the number of sensors connected in addition to the communications power. The power supply current consumption is expressed by the following formula.

Communications power supply current consumption = Bit Slave Unit communications current consumption + (actual load current × number of actuators used)

Input and Output Section Specifications

● 1-point Input and 1-point Output units

Input Section Specification

Item	Specification	
	CRT1B-MD02JS	CRT1B-MD02JS-1
Model	CRT1B-MD02JS	CRT1B-MD02JS-1
I/O capacity	1 input	
Internal I/O common	NPN	PNP
ON voltage	10.5 VDC min. (between each input terminal and the V terminal)	10.5 VDC min. (between each input terminal and the G terminal)
OFF voltage	---	---
OFF current	1.0 mA max.	
Input current	3.0 mA min./input (at 10.5 VDC)	
Sensor power supply voltage	Communications power supply voltage 0 V (max.) Communications power supply voltage -1 V (min.)	
ON delay	1.5 ms max.	
OFF delay	1.5 ms max.	
Number of circuits per common	1 input/common	
Power short-circuit detection	Not supported.	
Isolation method	No isolation	
Input indicators	LEDs (yellow)	
Degree of protection	IEC standard IP20	
Installation	M4 screw mounting using CRT1B-ATT03 Mounting Bracket	
Power supply type	Network power supply	
Communications power supply current consumption (See note.)	25 mA max. for 24-VDC power supply voltage 30 mA max. for 14-VDC power supply voltage	
Input device supply current	50 mA/point (G terminal)	50 mA/point (V terminal)
Weight	16 g max.	

Output Section Specification

Item	Specification	
	CRT1B-MD02JS	CRT1B-MD02JS-1
Model	CRT1B-MD02JS	CRT1B-MD02JS-1
I/O capacity	1 output	
Internal I/O common	NPN	PNP
Rated output current	0.1 A/output	
Load power supply voltage	Communications power supply voltage 0 V (max.) Communications power supply voltage -1.2 V (min.)	
Residual voltage	1.2 V max. (DC, 0.1 A, between each output terminal and G terminal)	1.2 V max. (DC, 0.1 A, between each output terminal and V terminal)
Leakage current	0.1 mA max.	
ON delay	0.5 ms max.	
OFF delay	1.5 ms max.	
Number of circuits per common	1 output/common	
Load short-circuit detection	Not supported.	
Isolation method	No isolation	
Output indicators	LEDs (yellow)	
Degree of protection	IEC standard IP20	
Installation	M4 screw mounting using CRT1B-ATT03 Mounting Bracket	
Power supply type	Network power supply	
Output device supply current	30 mA/point (G terminal)	30 mA/point (V terminal)

Note: The current consumption is for Bit Slave Unit communications current when all inputs are OFF, i.e., it does not include input device current consumption. The communications power supply is also used for the I/O power supply for sensors. Be sure to consider the sensor current consumption and the number of sensors connected in addition to the communications power. The power supply current consumption is expressed by the following formula.

$$\text{Communications power supply current consumption} = \text{Bit Slave Unit communications current consumption} + (\text{Bit Slave Unit input current} \times \text{number of inputs used}) + (\text{sensor current consumption} \times \text{number of sensors used})$$

● 2-points Inputs and 2-points Outputs units

Input Section Specification

Item	Specification	
Model	CRT1B-MD04JS	CRT1B-MD04JS-1
I/O capacity	2 inputs	
Internal I/O common	NPN	PNP
ON voltage	10.5 VDC min. (between each input terminal and the V terminal)	10.5 VDC min. (between each input terminal and the G terminal)
OFF voltage	---	---
OFF current	1.0 mA max.	
Input current	3.0 mA min./input (at 10.5 VDC)	
Sensor power supply voltage	Communications power supply voltage 0 V (max.) Communications power supply voltage -1 V (min.)	
ON delay	1.5 ms max.	
OFF delay	1.5 ms max.	
Number of circuits per common	2 inputs/common	
Power short-circuit detection	Not supported.	
Isolation method	No isolation	
Input indicators	LEDs (yellow)	
Degree of protection	IEC standard IP20	
Installation	M4 screw mounting using CRT1B-ATT03 Mounting Bracket	
Power supply type	Network power supply	
Communications power supply current consumption (See note.)	35 mA max. for 24-VDC power supply voltage 40 mA max. for 14-VDC power supply voltage	
Input device supply current	50 mA/point (G terminal)	50 mA/point (V terminal)
Weight	21 g max.	

Output Section Specification

Item	Specification	
Model	CRT1B-MD04JS	CRT1B-MD04JS-1
I/O capacity	2 outputs	
Internal I/O common	NPN	PNP
Rated output current	0.1 A/output	
Load power supply voltage	Communications power supply voltage 0 V (max.) Communications power supply voltage -1.2 V (min.)	
Residual voltage	1.2 V max. (DC, 0.1 A, between each output terminal and G terminal)	1.2 V max. (DC, 0.1 A, between each output terminal and V terminal)
Leakage current	0.1 mA max.	
ON delay	0.5 ms max.	
OFF delay	1.5 ms max.	
Number of circuits per common	2 outputs/common	
Load short-circuit detection	Not supported.	
Isolation method	No isolation	
Output indicators	LEDs (yellow)	
Degree of protection	IEC standard IP20	
Installation	M4 screw mounting using CRT1B-ATT03 Mounting Bracket	
Power supply type	Network power supply	
Output device supply current	30 mA/point (G terminal)	30 mA/point (V terminal)

Note: The current consumption is for Bit Slave Unit communications current when all inputs are OFF, i.e., it does not include input device current consumption. The communications power supply is also used for the I/O power supply for sensors. Be sure to consider the sensor current consumption and the number of sensors connected in addition to the communications power. The power supply current consumption is expressed by the following formula.

Communications power supply current consumption = Bit Slave Unit communications current consumption + (Bit Slave Unit input current × number of inputs used) + (sensor current consumption × number of sensors used)

Wiring

Wire colors have been changed according to revisions in the JIS standards for photoelectric and proximity sensors. The colors in parentheses are the wire colors prior to the revisions.

The I/O connector section uses compact connectors. Pin arrangements and signals are shown below.

● **2-points Inputs/4-points Inputs type**

CRT1B-ID02JS (NPN)
CRT1B-ID04JS (NPN)

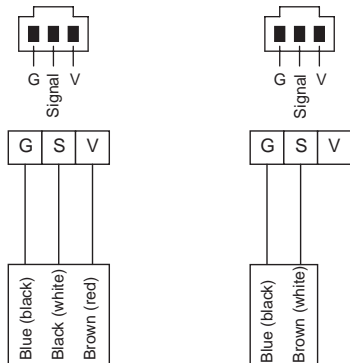

3-wire sensor with NPN output (photoelectric sensor or proximity sensor)

2-wire sensor (e.g., limit switch)

CRT1B-ID02JS-1 (PNP)
CRT1B-ID04JS-1 (NPN)

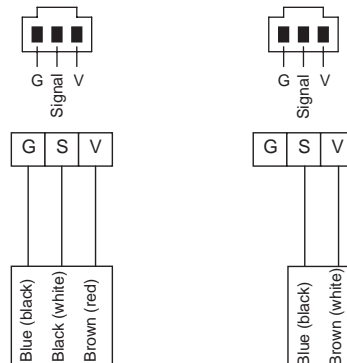

3-wire sensor with PNP output (photoelectric sensor or proximity sensor)

2-wire sensor (e.g., limit switch)

● **2-points Outputs/4-points Outputs type**

CRT1B-OD02JS (NPN)
CRT1B-OD04JS (NPN)

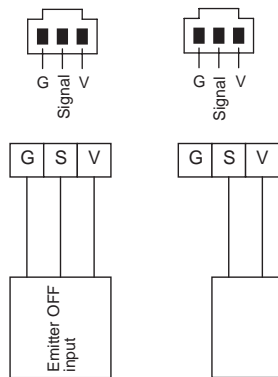

Photoelectric sensor, emitter, etc.

Solenoid, valve, etc.

CRT1B-OD02JS-1 (PNP)
CRT1B-OD04JS-1 (PNP)

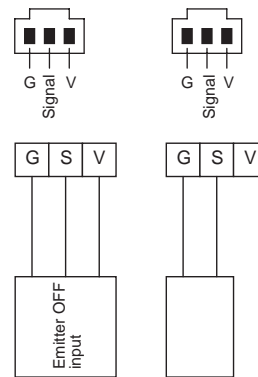

Photoelectric sensor, emitter, etc.

Solenoid, valve, etc.

● 1-point Input/1-point Output type, 2-points Inputs/2-points Outputs type

CRT1B-MD02JS (NPN)

CRT1B-MD04JS (NPN)

Input Connectors

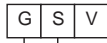
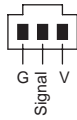
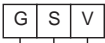
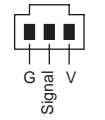

3-wire sensor with NPN output (photoelectric sensor or proximity sensor)

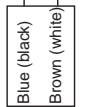

2-wire sensor (e.g., limit switch)

Output Connectors

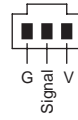
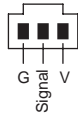

Photoelectric sensor, emitter, etc.



Solenoid, valve, etc.

CRT1B-MD02JS-1 (PNP)

CRT1B-MD04JS-1 (PNP)

Input Connectors

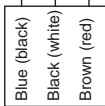
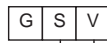
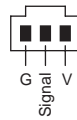
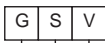
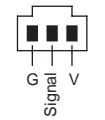

3-wire sensor with PNP output (photoelectric sensor or proximity sensor)

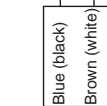

2-wire sensor (e.g., limit switch)

Output Connectors

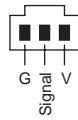
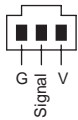

Photoelectric sensor, emitter, etc.



Solenoid, valve, etc.

Dimensions

(Unit: mm)

● 2-points Inputs, 2-points Outputs, 1-point Input/1-point Output type

- CRT1B-ID02JS
- CRT1B-ID02JS-1
- CRT1B-OD02JS
- CRT1B-OD02JS-1
- CRT1B-MD02JS
- CRT1B-MD02JS-1

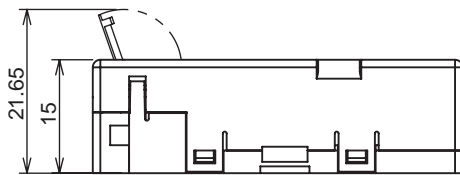
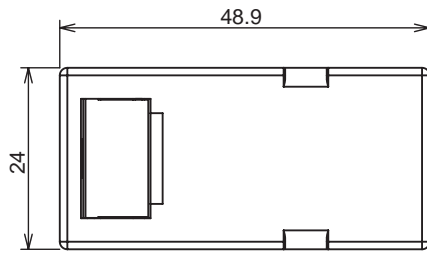

● 4-points Inputs, 4-points Outputs, 2-points Inputs/2-points Outputs type

- CRT1B-ID04JS
- CRT1B-ID04JS-1
- CRT1B-OD04JS
- CRT1B-OD04JS-1
- CRT1B-MD04JS
- CRT1B-MD04JS-1

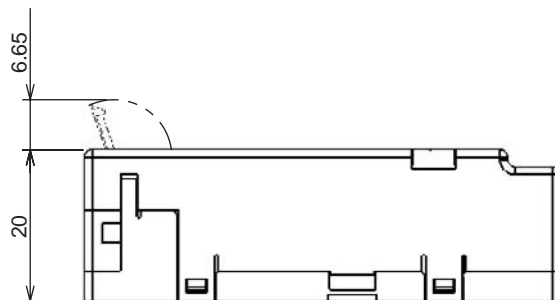
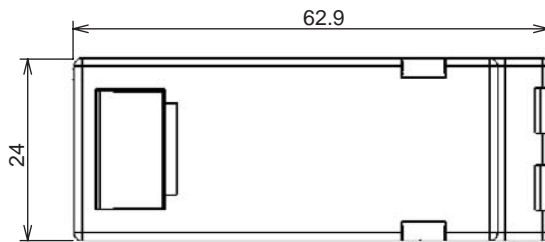

Read and Understand This Catalog

Please read and understand this catalog before purchasing the products. Please consult your OMRON representative if you have any questions or comments.

Warranty and Limitations of Liability

WARRANTY

OMRON's exclusive warranty is that the products are free from defects in materials and workmanship for a period of one year (or other period if specified) from date of sale by OMRON.

OMRON MAKES NO WARRANTY OR REPRESENTATION, EXPRESS OR IMPLIED, REGARDING NON-INFRINGEMENT, MERCHANTABILITY, OR FITNESS FOR PARTICULAR PURPOSE OF THE PRODUCTS. ANY BUYER OR USER ACKNOWLEDGES THAT THE BUYER OR USER ALONE HAS DETERMINED THAT THE PRODUCTS WILL SUITABLY MEET THE REQUIREMENTS OF THEIR INTENDED USE. OMRON DISCLAIMS ALL OTHER WARRANTIES, EXPRESS OR IMPLIED.

LIMITATIONS OF LIABILITY

OMRON SHALL NOT BE RESPONSIBLE FOR SPECIAL, INDIRECT, OR CONSEQUENTIAL DAMAGES, LOSS OF PROFITS OR COMMERCIAL LOSS IN ANY WAY CONNECTED WITH THE PRODUCTS, WHETHER SUCH CLAIM IS BASED ON CONTRACT, WARRANTY, NEGLIGENCE, OR STRICT LIABILITY.

In no event shall the responsibility of OMRON for any act exceed the individual price of the product on which liability is asserted.

IN NO EVENT SHALL OMRON BE RESPONSIBLE FOR WARRANTY, REPAIR, OR OTHER CLAIMS REGARDING THE PRODUCTS UNLESS OMRON'S ANALYSIS CONFIRMS THAT THE PRODUCTS WERE PROPERLY HANDLED, STORED, INSTALLED, AND MAINTAINED AND NOT SUBJECT TO CONTAMINATION, ABUSE, MISUSE, OR INAPPROPRIATE MODIFICATION OR REPAIR.

Application Considerations

SUITABILITY FOR USE

OMRON shall not be responsible for conformity with any standards, codes, or regulations that apply to the combination of products in the customer's application or use of the products.

At the customer's request, OMRON will provide applicable third party certification documents identifying ratings and limitations of use that apply to the products. This information by itself is not sufficient for a complete determination of the suitability of the products in combination with the end product, machine, system, or other application or use.

The following are some examples of applications for which particular attention must be given. This is not intended to be an exhaustive list of all possible uses of the products, nor is it intended to imply that the uses listed may be suitable for the products:

- Outdoor use, uses involving potential chemical contamination or electrical interference, or conditions or uses not described in this catalog.
- Nuclear energy control systems, combustion systems, railroad systems, aviation systems, medical equipment, amusement machines, vehicles, safety equipment, and installations subject to separate industry or government regulations.
- Systems, machines, and equipment that could present a risk to life or property.

Please know and observe all prohibitions of use applicable to the products.

NEVER USE THE PRODUCTS FOR AN APPLICATION INVOLVING SERIOUS RISK TO LIFE OR PROPERTY WITHOUT ENSURING THAT THE SYSTEM AS A WHOLE HAS BEEN DESIGNED TO ADDRESS THE RISKS, AND THAT THE OMRON PRODUCTS ARE PROPERLY RATED AND INSTALLED FOR THE INTENDED USE WITHIN THE OVERALL EQUIPMENT OR SYSTEM.

PROGRAMMABLE PRODUCTS

OMRON shall not be responsible for the user's programming of a programmable product, or any consequence thereof.

Disclaimers

CHANGE IN SPECIFICATIONS

Product specifications and accessories may be changed at any time based on improvements and other reasons.

It is our practice to change model numbers when published ratings or features are changed, or when significant construction changes are made. However, some specifications of the products may be changed without any notice. When in doubt, special model numbers may be assigned to fix or establish key specifications for your application on your request. Please consult with your OMRON representative at any time to confirm actual specifications of purchased products.

DIMENSIONS AND WEIGHTS

Dimensions and weights are nominal and are not to be used for manufacturing purposes, even when tolerances are shown.

PERFORMANCE DATA

Performance data given in this catalog is provided as a guide for the user in determining suitability and does not constitute a warranty. It may represent the result of OMRON's test conditions, and the users must correlate it to actual application requirements. Actual performance is subject to the OMRON Warranty and Limitations of Liability.

ERRORS AND OMISSIONS

The information in this document has been carefully checked and is believed to be accurate; however, no responsibility is assumed for clerical, typographical, or proofreading errors, or omissions.

2010.3

In the interest of product improvement, specifications are subject to change without notice.

OMRON Corporation
Industrial Automation Company

<http://www.ia.omron.com/>

(c)Copyright OMRON Corporation 2010 All Right Reserved.