

Tous droits strictement réservés. Reproduction ou communication a des tiers interdite sous quelque forme que ce soit sans autorisation écrite du propriétaire. Propriété de c FCI. Droits de reproduction FCI.

All rights strictly reserved. Reproduction or issue to third parties in any form whatever is not permitted without written authority from the proprietor. Property of FCI. Copyright FCI.

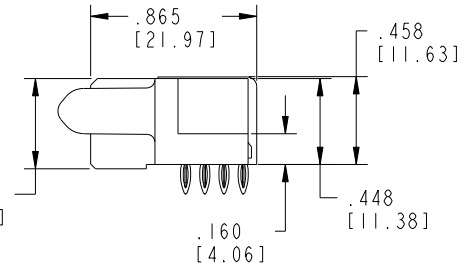
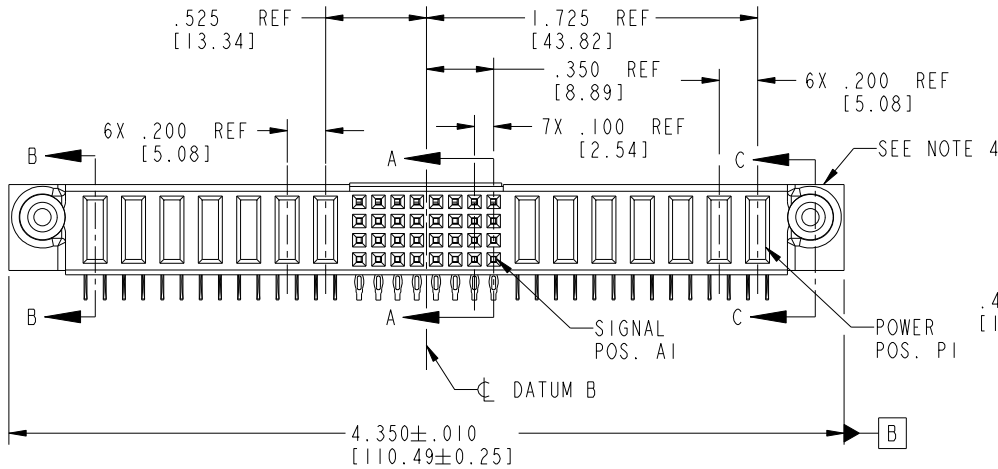
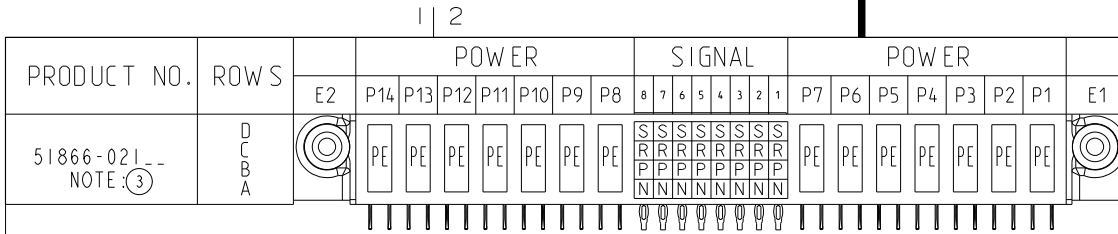

CODE	DIM "M" MATING LENGTH	CONTACT TYPE
N	N/A [N/A]	SIGNAL
P	N/A [N/A]	SIGNAL
R	N/A [N/A]	SIGNAL
S	N/A [N/A]	SIGNAL
PE	.042 [1.07]	POWER

mat'l code SEE NOTE 2				tolerances unless otherwise specified		CUSTOMER		FCI	
ltr	ecn no.	dr	date	linear	.XX±.01/0.X±0.3	COPY		www.fciconnect.com	
A	V03-1128	TAB	10/20/03		.XXX±.005/0.XX±0.13	projection		title 7P + 32S + 7P	
B	DG05-0168	SJ	06/17/05		.XXX±.002/0.XXX±0.051	INCH/MM		R/A PRESS-FIT RECEPTACLE	
C	DG08-0251	W D	09/16/08	angles	0°±2°	scale		product family PwrBlade code 213	
				dr	T. BRUNGARD 10/20/03	1:1		size dwg no	
				engr	M. GRAY 10/20/03			A 51866-021	
				chr	M. GRAY 10/20/03			sheet 1 of 4	
				appd	M. GRAY 10/20/03				
sheet index	revision sheet	C 1	C 2	C 3	C 4				

Pro/E

PDM: Rev: C

STATUS: Released

Printed: Dec 20, 2010

cage code 22536

Tous droits strictement réservés. Reproduction ou communication a des tiers interdite sous quelque forme que ce soit sans autorisation écrite du propriétaire. Propriété de c FCI. Droits de reproduction FCI.

All rights strictly reserved. Reproduction or issue to third parties in any form whatever is not permitted without written authority from the proprietor. Property of FCI. Copyright FCI.



PRODUCT NUMBER  
51866-021--  
NOTE:③

.010 REF  
[0.25]

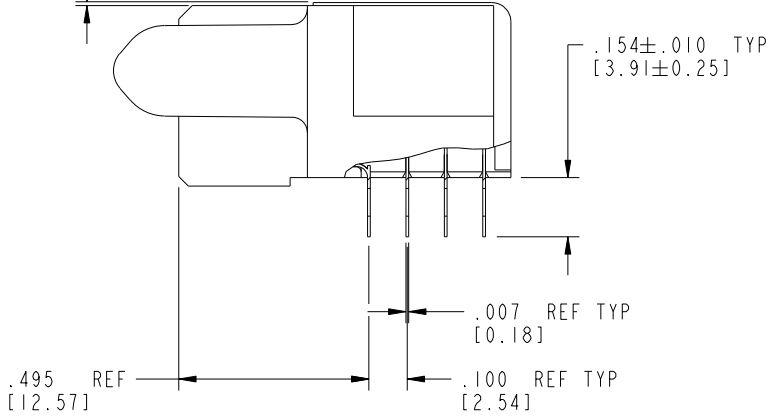

BROKEN-OUT SECTION A-A  
SCALE 2:1

DIM "M" ±0.010  
[±0.25]

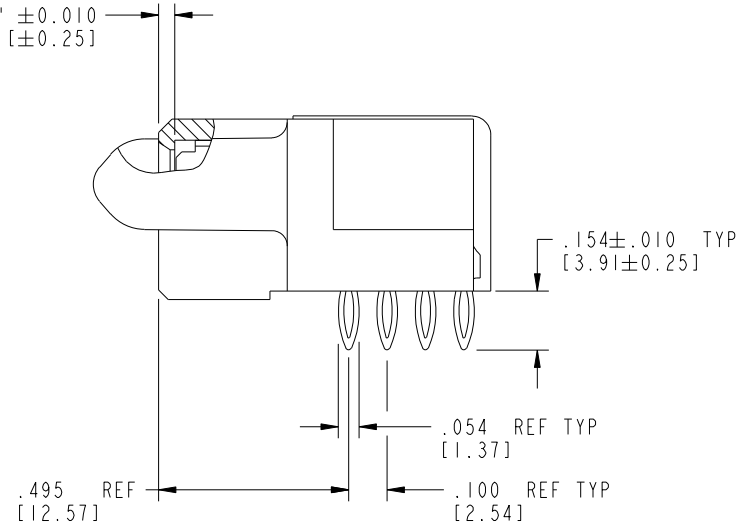

BROKEN-OUT SECTION B-B  
SCALE 2:1

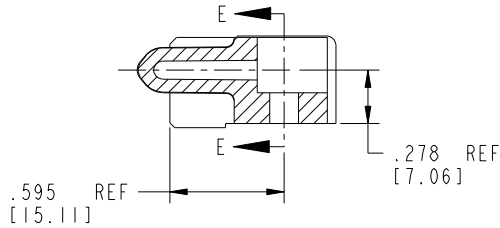

SECTION C-C

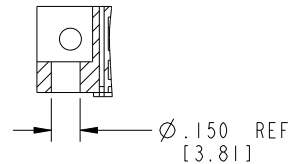

PARTIAL SECTION E-E

mat'l code		SEE NOTE 2		tolerances unless otherwise specified		CUSTOMER		FCI	
lfr	ecn no.	dr	date	linear	.XX±.01/0.X±0.3	COPY		www.fciconnect.com	
C				projection	.XXY±.005/0.XX±0.13	INCH/MM		title 7P + 32S + 7P	
				angles	.XXX±.0020/0.XXX±0.051	INCH/MM		R/A PRESS-FIT RECEPTACLE	
				dr	0°±2°	scale		product family PwrBlade code	
				engr	T. BRUNGARD 10/20/03	1:1		size dwg no 213	
				chr	M. GRAY 10/20/03			sheet	
				appd	M. GRAY 10/20/03			A 51866-021 2 of 4	
sheet index	revision sheet								

Pro/E

PDM: Rev: C

STAT: Released

Printed: Dec 20, 2010

Tous droits strictement réservés. Reproduction ou communication a des tiers interdite sous quelque forme que ce soit sans autorisation écrite du propriétaire. Propriété de c FCI. Droits de reproduction FCI.

All rights strictly reserved. Reproduction or issue to third parties in any form whatever is not permitted without written authority from the proprietor. Property of FCI. Copyright FCI.



PRODUCT NUMBER  
51866-021--  
NOTE:③

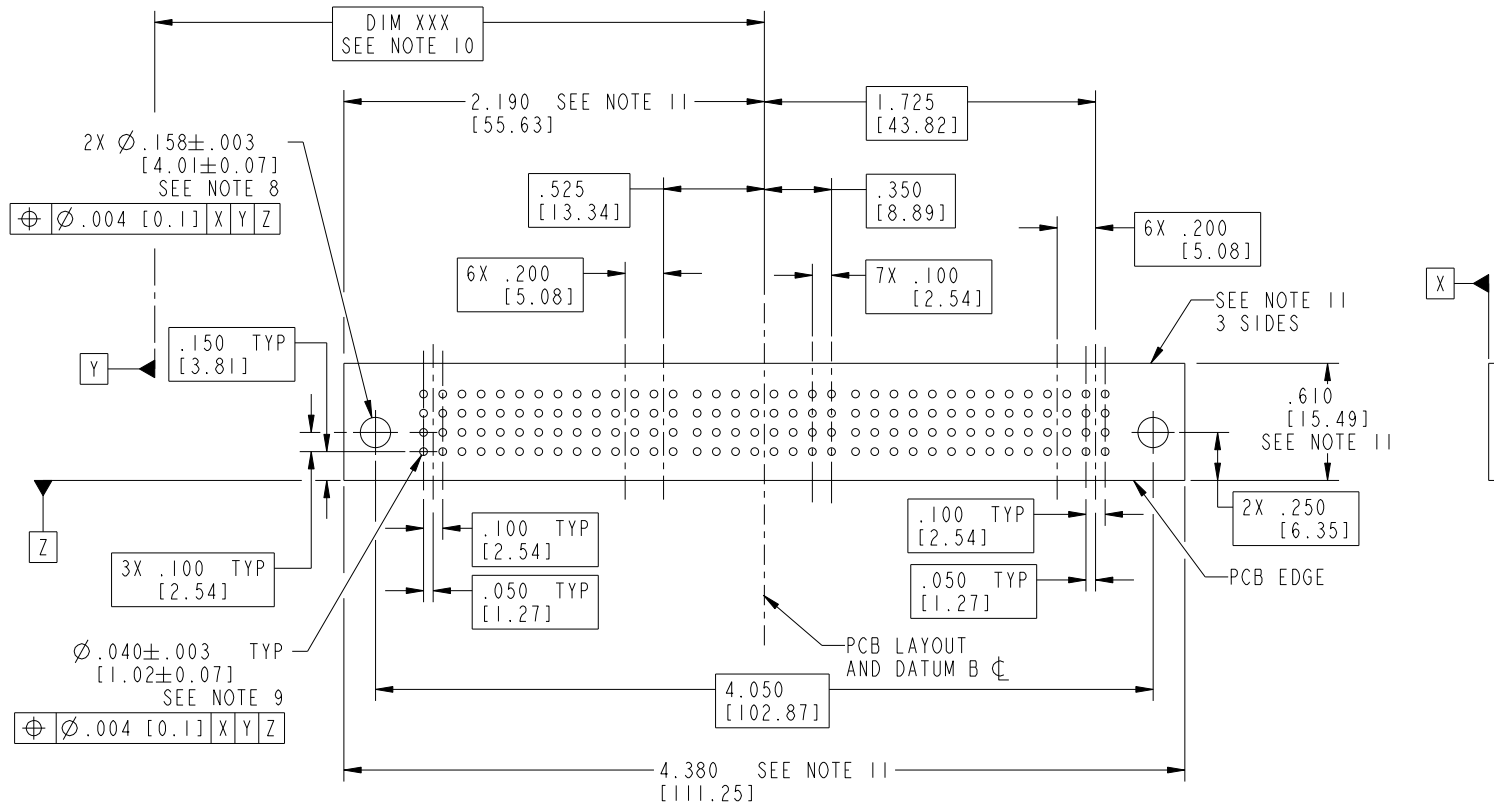

RECOMMENDED PCB LAYOUT

mat'l code		SEE NOTE 2		tolerances unless otherwise specified		CUSTOMER		 www.fciconnect.com	
ltr	ecn no.	dr	date	linear	.XX±.01/0.X±0.3	COPY		title	
C				angles	.XX±.005/0.XX±0.13	projection		7P + 32S + 7P	
					.XXX±.0020/0.XXX±0.051			R/A PRESS-FIT RECEPTACLE	
				dr	0°±2°	INCH/MM		product family	
				engr	T. BRUNGARD 10/20/03	scale		PwrBlade	
				chr	M. GRAY 10/20/03	1:1		code	
				appd	M. GRAY 10/20/03			213	
sheet index		revision sheet						size	
								dwg no	
								A 51866-021	
								sheet	
								3 of 4	

cage code 28526

Pro/E

PDM: Rev: C

STATUS: Released

Printed: Dec 20, 2010

Tous droits strictement réservés. Reproduction ou communication a des tiers interdite sous quelque forme que ce soit sans autorisation écrite du propriétaire. Propriété de c FCI. Droits de reproduction FCI.



All rights strictly reserved. Reproduction or issue to third parties in any form whatever is not permitted without written authority from the proprietor. Property of FCI. Copyright FCI.

1 | 2

3

4

PRODUCT NUMBER  
51866-021--  
NOTE: (3)

NOTES:

1. DIMENSIONS AND TOLERANCES ARE IN ACCORDANCE WITH ASME Y14.5M, 1994 UNLESS OTHERWISE SPECIFIED.

CONNECTOR NOTES:

(2) HOUSING MATERIAL: UL 94 V-0 GLASS FILLED HIGH-TEMP THERMOPLASTIC  
POWER CONTACT MATERIAL: COPPER ALLOY  
SIGNAL PIN MATERIAL: COPPER ALLOY

△ 3. SEE ITEM 7 & 8 IN PRINT 10064183 FOR PLATING SPEC OF 51866-021 AND 51866-021LF RESPECTIVELY.

(4) MANUFACTURER'S NAME, P/N, AND DATE CODE TO APPEAR ON THIS SURFACE.

5. PRODUCT SPECIFICATION GS-12-149.  
APPLICATION SPECIFICATION BUS-20-067.

6. PACKAGED IN TRAYS.

PCB NOTES:

7. ALL HOLE DIAMETERS ARE FINISHED HOLE SIZE.

(8) MOUNTING HOLES, WHERE APPLICABLE, ARE UNPLATED.

(9)  $\varnothing .0453 \pm .0010$  [1.151 ± 0.025] DRILLED HOLES PLATED WITH  
.0003 [0.008] MIN SnPb OVER .001 [0.03]  
TO .003 [0.08] Cu PLATING TO ACHIEVE  
 $\varnothing .040 \pm .003$  [1.02 ± .07] HOLE.

(10) "DIM XXX" TO BE DETERMINED BY THE CUSTOMER.

(11) CONNECTOR KEEP-OUT ZONE.

12. USE FCI CAM TOOL 430140-XXX TO APPLY CONNECTOR TO PCB.

13. △ SYMBOL WILL BE NEXT TO ANY DIMENSION, VIEW, OR NOTE WHICH HAS BEEN MODIFIED WITH THE CURRENT DRAWING REVISION.

mat'l code		SEE NOTE 2		tolerances unless otherwise specified		CUSTOMER		FCI	
ltr	ecn no.	dr	date	linear	.XX±.01/0.X±0.3	COPY		www.fciconnect.com	
C				projection	.XXX±.005/0.XX±0.13	R/A		7P + 32S + 7P	
				angles	.XXX±.0020/0.XXX±0.051	INCH/MM		R/A PRESS-FIT RECEPTACLE	
				dr	0° ± 2°	scale		product family PwrBlade code	
				enrg	T. BRUNGARD 10/20/03	1:1		size dwg no 213	
				chr	M. GRAY 10/20/03	A		51866-021 sheet	
				appd	M. GRAY 10/20/03			4 of 4	
sheet index	revision sheet								

1 | 2

Pro/E

PDM: Rev: C

STATUS: Released

Printed: Dec 20, 2010

A

A

B

B