

REVISIONS				
REV.	ECO. NO	DESCRIPTION	DATE	BY
A	2522	INITIAL RELEASE	5/31/2012	JH

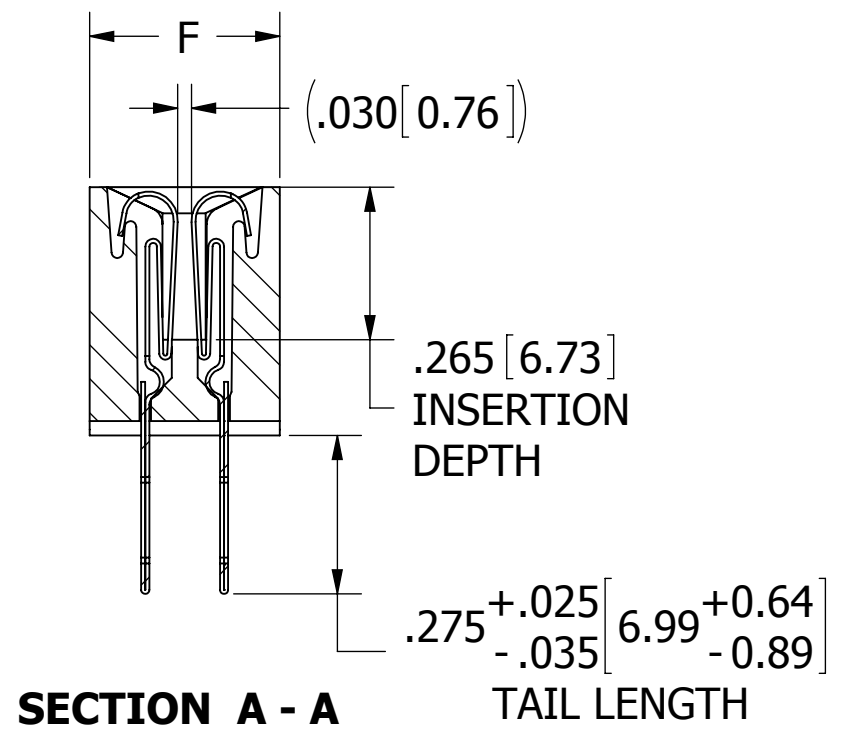

**MP \_ \_ - 100 - \_ \_ - DP - 1 \_ \_**

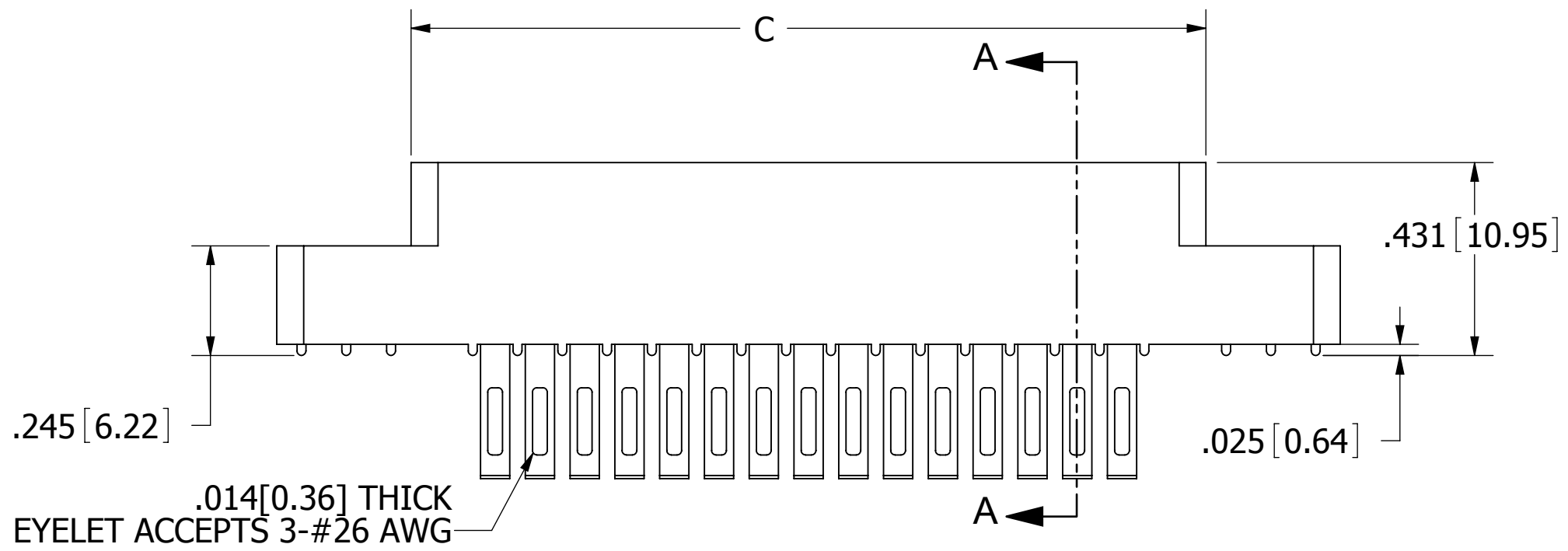
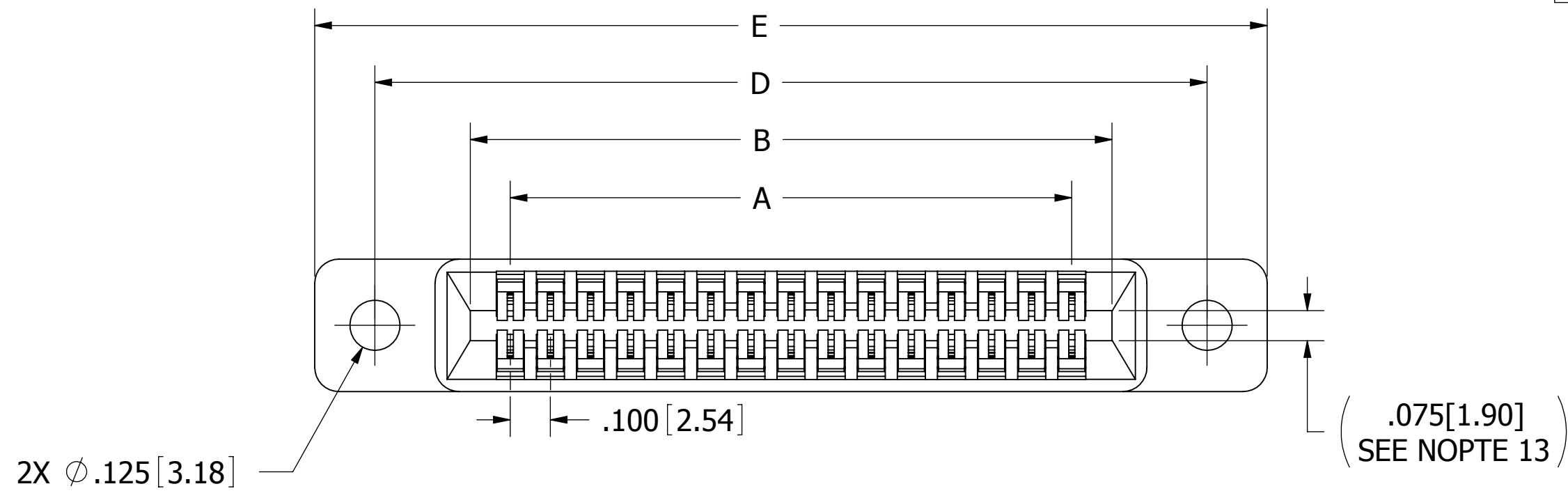
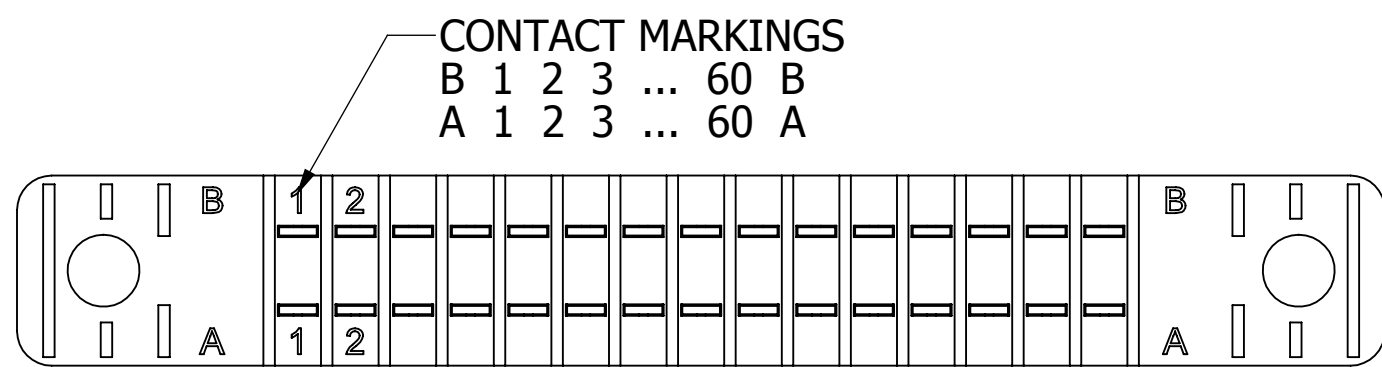

- NOTES:**
- INSULATOR MATERIAL: SEE PART NUMBER CODING
  - CONTACT MATERIAL: SEE PART NUMBER CODING
  - PLATING: SEE PART NUMBER CODING
  - OPERATING TEMPERATURE: SEE PART NUMBER CODING
  - PROCESSING TEMP: SEE PART NUMBER CODING
  - UL FLAMMABILITY RATING: 94V-0
  - OPERATING VOLTAGE: 700 VAC MINIMUM AT SEA LEVEL
  - CURRENT RATING: 3 AMP PER CONTACT
  - CONTACT RESISTANCE: 30 MILLI OHMS MAX
  - INSULATION RESISTANCE: 5000 MEGA OHMS
  - DURABILITY: 500 CYCLES MIN
  - CONNECTOR IDENTIFICATION: THE PART SHALL BE MARKED WITH A PART NUMBER AND LOT CODE
  - BOARD THICKNESS ACCOMMODATED:  $.062 \pm .008 [1.57 \pm 0.20]$
  - INSERTION FORCE: 16 OZ MAX PER CONTACT PAIR WHEN USING A  $.062 [1.57]$  TEST BLADE  
INTERNAL INSPECTION TO BE PER SULLIN'S WORK INSTRUCTION WI7.3-01
  - WITHDRAWAL FORCE: 1 OZ MIN PER CONTACT PAIR USING  $.062 [1.57]$  PCB

REF: \_ \_ C \_ \_ DTE \_ (-S38, S81, S328)

**CUSTOMER COPY**



UNLESS OTHERWISE SPECIFIED: DIMENSIONS ARE IN INCHES [MM]		DRAWN	DATE	NAME	
TOLERANCES: ANGULAR: $\pm 1^\circ$ DECIMALS .XX = $\pm .02 [ .5]$ .XXX = $\pm .005 [ .13]$ .XXXX = $\pm .0005 [ .013]$		5/31/2012	JH		
<small>THE INFORMATION HEREIN CONTAINS PROPRIETARY INFORMATION OF SULLINS ELECTRONICS AND IS NOT TO BE REPRODUCED, USED OR DISCLOSED TO OTHERS FOR ANY PURPOSE EXCEPT AS SPECIFICALLY AUTHORIZED IN WRITING BY AN OFFICER OF SULLINS ELECTRONICS.</small>					<b>TITLE</b> EDGE CARD, .100 CC LP
<b>PART NUMBER</b> MP _ _ - 100 - _ _ - DP - _ _					<b>SCALE</b> : 3:1
SIZE	CAGE CODE	DWG. NO.	REV		
C	54453	C11935	A		
SHEET 1 OF 3			FILE NAME: C11935, MP _ _ - 100 - _ _ - DP - _ _ , REF _ _ C _ _ DTE _ OMIT, S38, S81, S328		

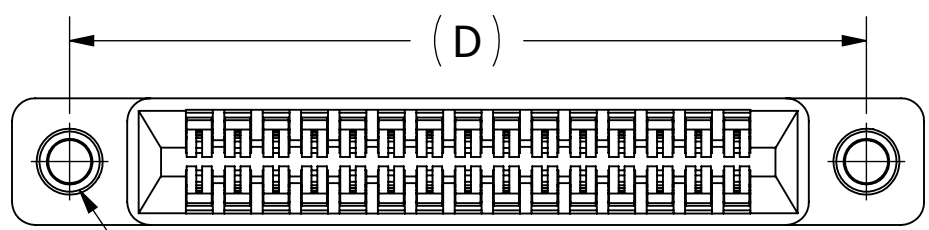

2X #4-40 THREADED INSERTS

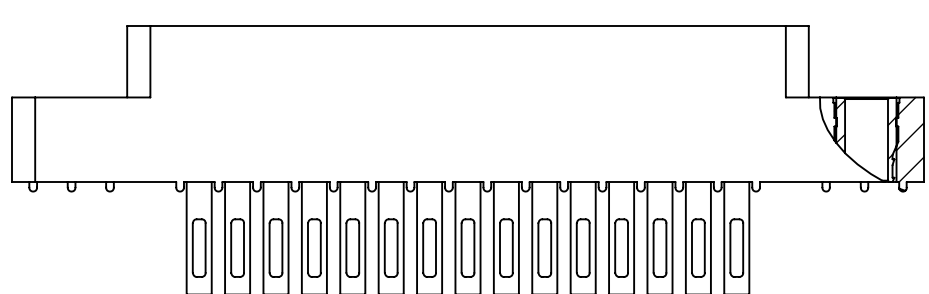

**MP - 100 - DP-2**

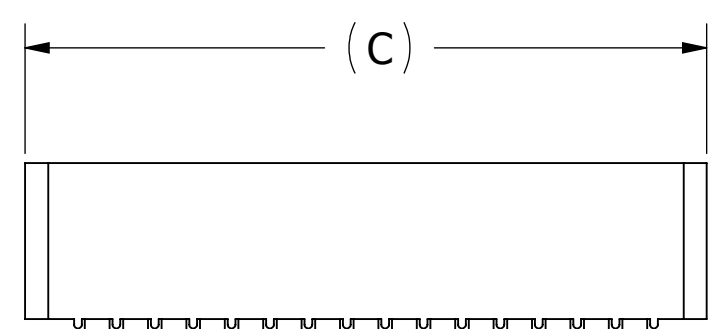
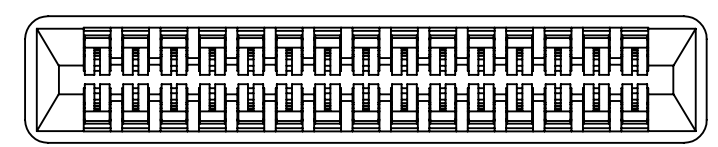

**MP - 100 - DP-4**

2X FLOATING BOBBIN  
 $\phi .116 [2.95]$   
 CLEARANCE FOR  
 # 4 SCREW

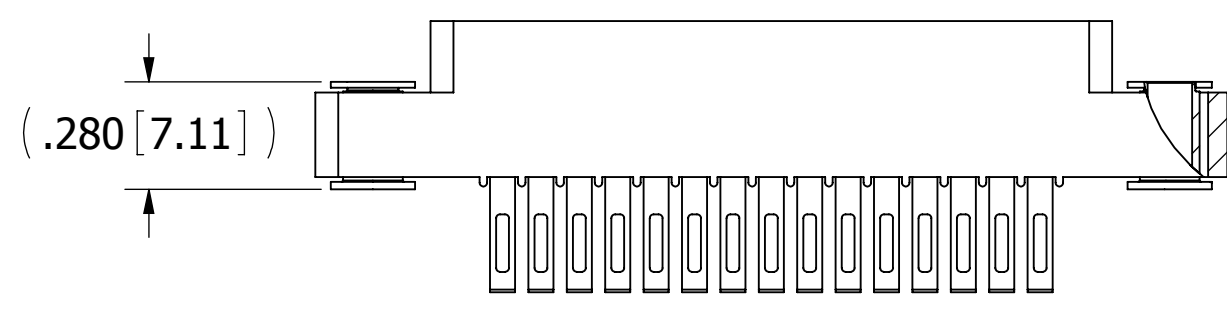
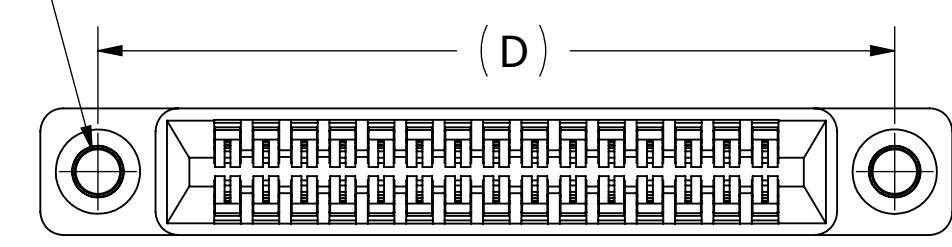

**MP - 100 - DP-3**

# CUSTOMER COPY



UNLESS OTHERWISE SPECIFIED: DIMENSIONS ARE IN INCHES [MM]		DRAWN	DATE	NAME	
TOLERANCES: ANGULAR: $\pm 1^\circ$ DECIMALS .XX = $\pm .02 [ .5]$ .XXX = $\pm .005 [ .13]$ .XXXX = $\pm .0005 [ .013]$			5/31/2012	JH	
<small>THE INFORMATION HEREIN CONTAINS PROPRIETARY INFORMATION OF SULLINS ELECTRONICS AND IS NOT TO BE REPRODUCED, USED OR DISCLOSED TO OTHERS FOR ANY PURPOSE EXCEPT AS SPECIFICALLY AUTHORIZED IN WRITING BY AN OFFICER OF SULLINS ELECTRONICS.</small>					TITLE
					EDGE CARD, .100 CC LP
					PART NUMBER
					MP - 100 - DP -
SIZE	CAGE CODE	DWG. NO.		REV	
C	54453	C11935		A	
SCALE: 2:1				SHEET 2 OF 3	

PART NUMBER	NO. OF POS.	A±.008[0.20]		B±.008[0.20]		C±.015[0.38]		D±.010[0.25]		E±.020[0.51]		F+.005/-0.015[+0.13/-0.38]	
		IN	MM	IN	MM	IN	MM	IN	MM	IN	MM	IN	MM
MP - 100-05-DP-	5	0.400	10.16	0.600	15.24	0.775	19.69	1.075	27.31	1.375	34.93	0.330	8.38
MP - 100-06-DP-	6	0.500	12.70	0.700	17.78	0.875	22.23	1.175	29.85	1.475	37.47		
MP - 100-07-DP-	7	0.600	15.24	0.800	20.32	0.975	24.77	1.275	32.39	1.575	40.01		
MP - 100-08-DP-	8	0.700	17.78	0.900	22.86	1.075	27.31	1.375	34.93	1.675	42.55		
MP - 100-10-DP-	10	0.900	22.86	1.100	27.94	1.275	32.39	1.575	40.01	1.875	47.63		
MP - 100-12-DP-	12	1.100	27.94	1.300	33.02	1.475	37.47	1.775	45.09	2.075	52.71		
MP - 100-13-DP-	13	1.200	30.48	1.400	35.56	1.575	40.01	1.875	47.63	2.175	55.25		
MP - 100-15-DP-	15	1.400	35.56	1.600	40.64	1.775	45.09	2.075	52.71	2.375	60.33		
MP - 100-17-DP-	17	1.600	40.64	1.800	45.72	1.975	50.17	2.275	57.79	2.575	65.41		
MP - 100-18-DP-	18	1.700	43.18	1.900	48.26	2.075	52.71	2.375	60.33	2.675	67.95		
MP - 100-19-DP-	19	1.800	45.72	2.000	50.80	2.175	55.25	2.475	62.87	2.775	70.49		
MP - 100-20-DP-	20	1.900	48.26	2.100	53.34	2.275	57.79	2.575	65.41	2.875	73.03		
MP - 100-22-DP-	22	2.100	53.34	2.300	58.42	2.475	62.87	2.775	70.49	3.075	78.11		
MP - 100-23-DP-	23	2.200	55.88	2.400	60.96	2.575	65.41	2.875	73.03	3.175	80.65		
MP - 100-25-DP-	25	2.400	60.96	2.600	66.04	2.775	70.49	3.075	78.11	3.375	85.73		
MP - 100-26-DP-	26	2.500	63.50	2.700	68.58	2.875	73.03	3.175	80.65	3.475	88.27		
MP - 100-28-DP-	28	2.700	68.58	2.900	73.66	3.075	78.11	3.375	85.73	3.675	93.35		
MP - 100-30-DP-	30	2.900	73.66	3.100	78.74	3.275	83.19	3.575	90.81	3.875	98.43		
MP - 100-31-DP-	31	3.000	76.20	3.200	81.28	3.375	85.73	3.675	93.35	3.975	100.97		
MP - 100-35-DP-	35	3.400	86.36	3.600	91.44	3.775	95.89	4.075	103.51	4.375	111.13		
MP - 100-36-DP-	36	3.500	88.90	3.700	93.98	3.875	98.43	4.175	106.05	4.475	113.67		
MP - 100-40-DP-	40	3.900	99.06	4.100	104.14	4.275	108.59	4.575	116.21	4.875	123.83		
MP - 100-43-DP-	43	4.200	106.68	4.400	111.76	4.575	116.21	4.875	123.83	5.175	131.45		
MP - 100-44-DP-	44	4.300	109.22	4.500	114.30	4.675	118.75	4.975	126.37	5.275	133.99		
MP - 100-49-DP-	49	4.800	121.92	5.000	127.00	5.175	131.45	5.475	139.07	5.775	146.69		
MP - 100-50-DP-	50	4.900	124.46	5.100	129.54	5.275	133.99	5.575	141.61	5.875	149.23		
MP - 100-52-DP-	52	5.100	129.54	5.300	134.62	5.475	139.07	5.775	146.69	6.075	154.31		
MP - 100-60-DP-	60	5.900	149.86	6.100	154.94	6.275	159.39	6.575	167.01	6.875	174.63		
MP - 100-65-DP-	65	6.400	162.56	6.600	167.64	6.775	172.09	7.075	179.71	7.375	187.33		

**TABLE 1 (PLATING):**

ALL PLATINGS HAVE .000050" NICKEL UNDERPLATE

	CONTACT SURFACE	TERMINATION	PLATING MODIFICATION CODE
MP	.000010" GOLD OVERALL		OMIT
	.000030" GOLD	.000010" GOLD OVERALL	G
MPL	.000100" PURE TIN, MATTE OVERALL		K

(MPL PLATING AVAILABLE WITH PHOSPHOR BRONZE CONTACTS ONLY)

**TABLE 2 (PHOSPHOR BRONZE CONTACTS):**

INSULATOR MATERIAL CODE	OPERATING TEMPERATURE	PROCESSING TEMPERATURE
0, 2, 3	-65°C TO +125°C	260°C FOR 10 SEC MAX (230°C, 30 SEC)
1, 5, 6, 7	-65°C TO +125°C	260°C FOR 120 SEC MAX

**TABLE 3 (BERYLLIUM COPPER CONTACTS):**

INSULATOR MATERIAL CODE	OPERATING TEMPERATURE	PROCESSING TEMPERATURE
0, 2, 3	-65°C TO +125°C	260°C FOR 10 SEC MAX (230°C, 30 SEC)
1, 5, 6, 7	-65°C TO +150°C	260°C FOR 120 SEC MAX

**PART NUMBER CODING**

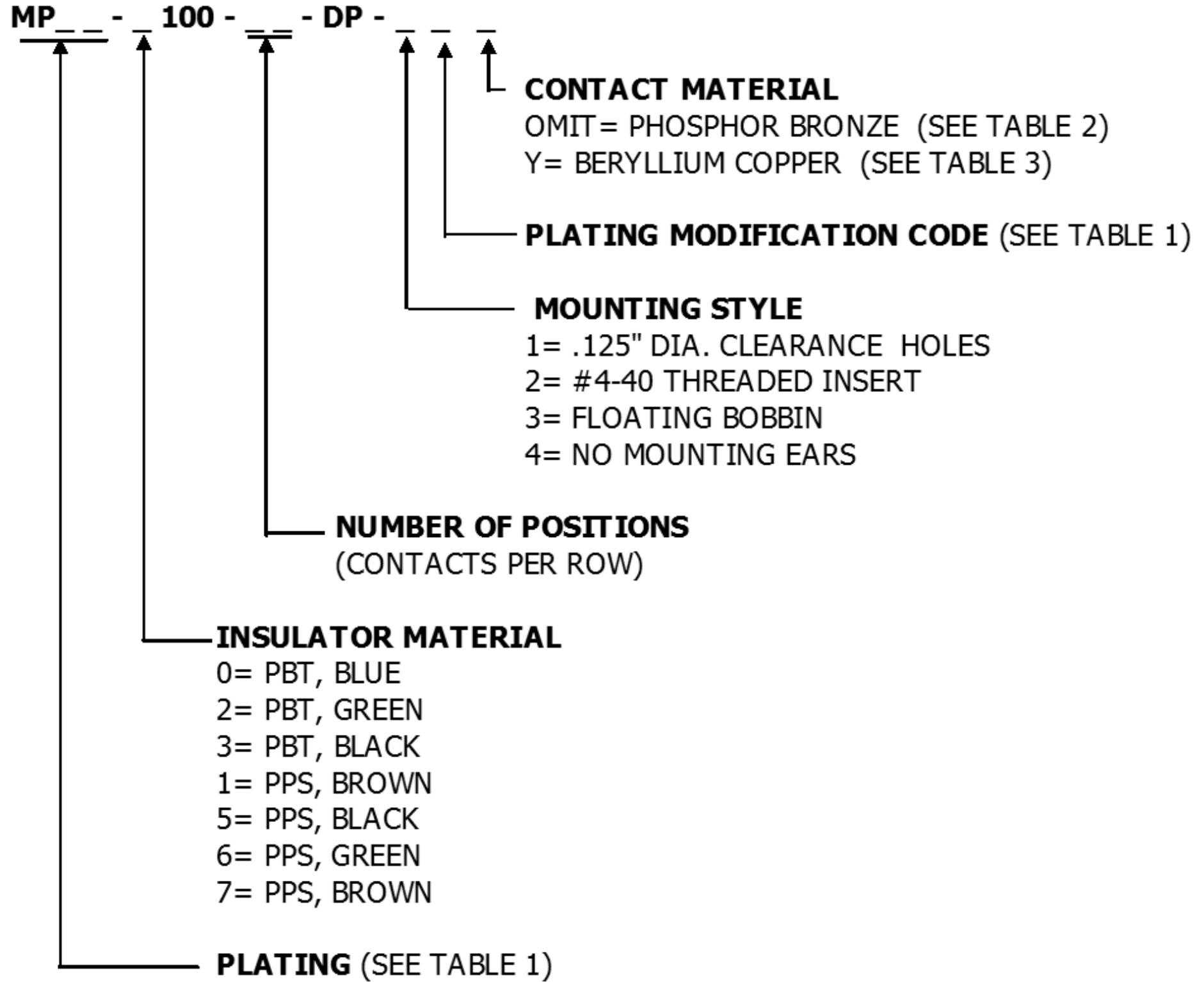

**CUSTOMER COPY**



UNLESS OTHERWISE SPECIFIED: DIMENSIONS ARE IN INCHES [MM]		DRAWN	DATE	NAME	
			5/31/2012	JH	
<small>THE INFORMATION HEREIN CONTAINS PROPRIETARY INFORMATION OF SULLINS ELECTRONICS AND IS NOT TO BE REPRODUCED, USED OR DISCLOSED TO OTHERS FOR ANY PURPOSE EXCEPT AS SPECIFICALLY AUTHORIZED IN WRITING BY AN OFFICER OF SULLINS ELECTRONICS.</small>					TITLE
					EDGE CARD, .100 CC LP
					PART NUMBER
					MP - 100 - DP -
SIZE	CAGE CODE	DWG. NO.			REV
C	54453	C11935			A
SCALE: 2:1					SHEET 3 OF 3