

## Technical Data Sheet

### 0.20" Single Digit SMD Display

**ELSS-206USRWA/S530-A3/S290**

#### Features

- Packaged in tape and reel for SMT manufacturing.
- Design flexibility (common cathode or anode).
- Categorized for luminous intensity.
- The thickness is thinner than tradition display.
- Pb free.
- The product itself will remain within RoHS compliant version.

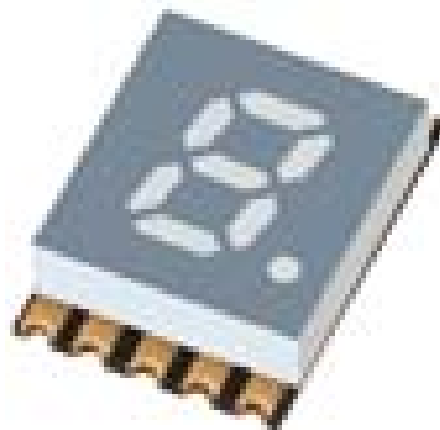

#### Descriptions

- The SMD type is much smaller than tradition type components, thus enable smaller board size, higher packing density, reduced storage space and finally smaller equipment to be obtained.

#### Applications

- Suitable for indoor use.
- Audio system.
- Set top box.
- Game machine.
- Channel indicator of TV.

#### Device Selection Guide

Chip		Face Color
Material	Emitted Color	
AlGaInP	Dark-Red	Gray

# Technical Data Sheet

## 0.20" Single Digit SMD Display

**ELSS-206USRWA/S530-A3/S290**

### Package Dimensions

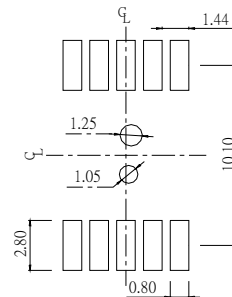
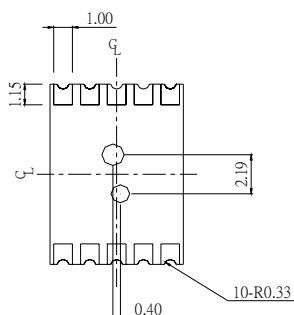
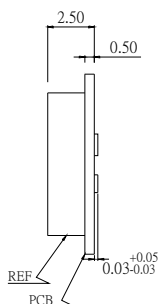
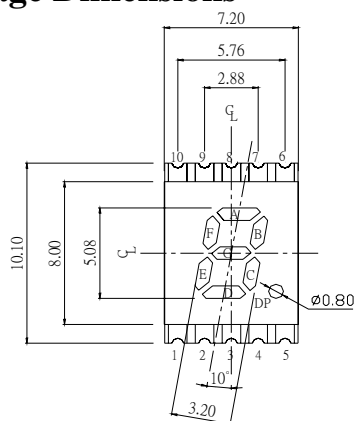

### Internal Connection Diagram

1. Cathode E
2. Cathode D
3. Common Anode
4. Cathode C
5. Cathode DP
6. Cathode B
7. Cathode A
8. Common Anode
9. Cathode F
10. Cathode G

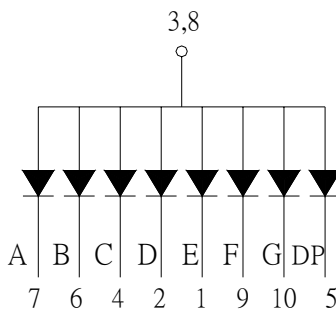

### Notes:

- All dimensions are in millimeters, tolerance is 0.25mm unless otherwise noted.
- Above specification may be changed without notice. Supplier will reserve authority on material change for above specification.

### Absolute Maximum Ratings (Ta=25°C)

Parameter	Symbol	Rating	Units
Forward Current	I <sub>F</sub>	25	mA
Pulse Forward Current <sup>*1</sup>	I <sub>FP</sub>	60	mA
Operating Temperature	T <sub>opr</sub>	-40 ~ +105	°C
Storage Temperature	T <sub>stg</sub>	-40 ~ +105	°C
Reflow Temperature <sup>*2</sup>	T <sub>ref</sub>	260	°C
Electrostatic Discharge	ESD	2000	V
Power Dissipation	P <sub>d</sub>	60	mW
Reverse Voltage	V <sub>R</sub>	5	V

**Notes:** \*1:I<sub>FP</sub> Conditions--Pulse Width ≤ 10msec and Duty ≤ 1/10.

\*2:Reflow time ≤ 5 seconds.

# Technical Data Sheet

## 0.20" Single Digit SMD Display

### ELSS-206USRWA/S530-A3/S290

#### Electro-Optical Characteristics (Ta=25°C)

Parameter		Symbol	Min.	Typ.	Max.	Units	Condition
Forward Voltage		$V_F$	--	2.0	2.4	V	$I_F=20mA$
Reverse Current		$I_R$	--	--	10	$\mu A$	$V_R=5V$
Luminous Intensity	Per segment	$I_v$	4.0	12.4	----	mcd	$I_F=10mA$
	Per decimal point	$I_v$	2.1	7.7	----		
Peak Wavelength		$\lambda_p$	--	639	--	nm	$I_F=20mA$
Dominant Wavelength		$\lambda_d$	--	631	--	nm	$I_F=20mA$
Spectrum Radiation Bandwidth		$\Delta \lambda$	--	20	--	nm	$I_F=20mA$

**Notes:** 1.Luminous Intensity per segment doesn't include decimal point.

#### Bin Range of Luminous Intensity (Unit: mcd)

Rank	Min.	Max.	Rank	Min.	Max.
N	4.0	6.4	R	11.0	17.6
P	5.6	8.9	S	15.0	24.0
Q	7.8	12.5	T	21.0	34.0

# Technical Data Sheet

## 0.20" Single Digit SMD Display

### ELSS-206USRWA/S530-A3/S290

#### Typical Electro-Optical Characteristics Curves

( U S R )

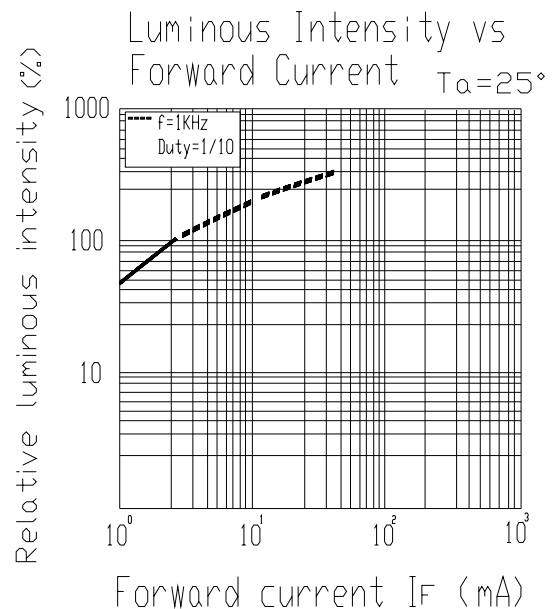
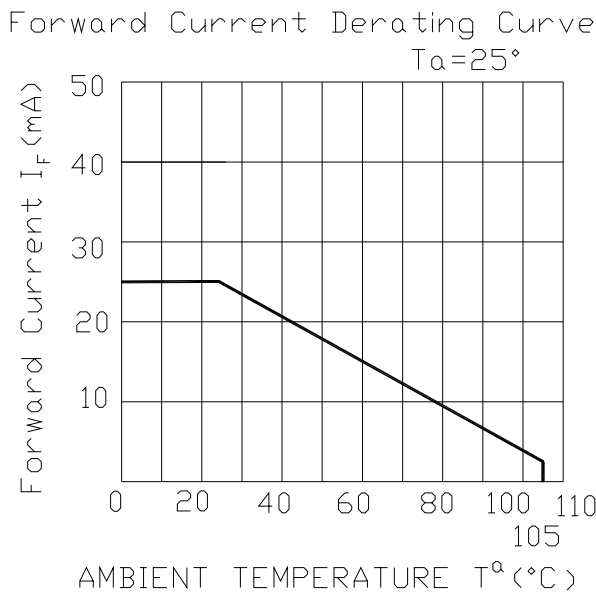
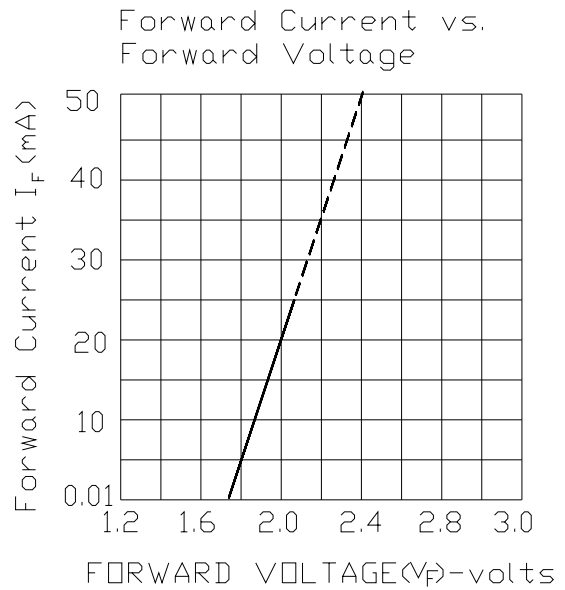
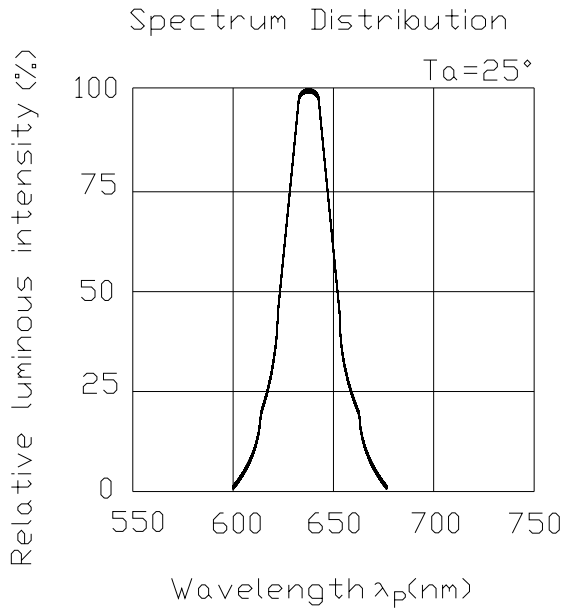

## Technical Data Sheet

### 0.20" Single Digit SMD Display

**ELSS-206USRWA/S530-A3/S290**

#### ■ Reflow Temp. / Time :

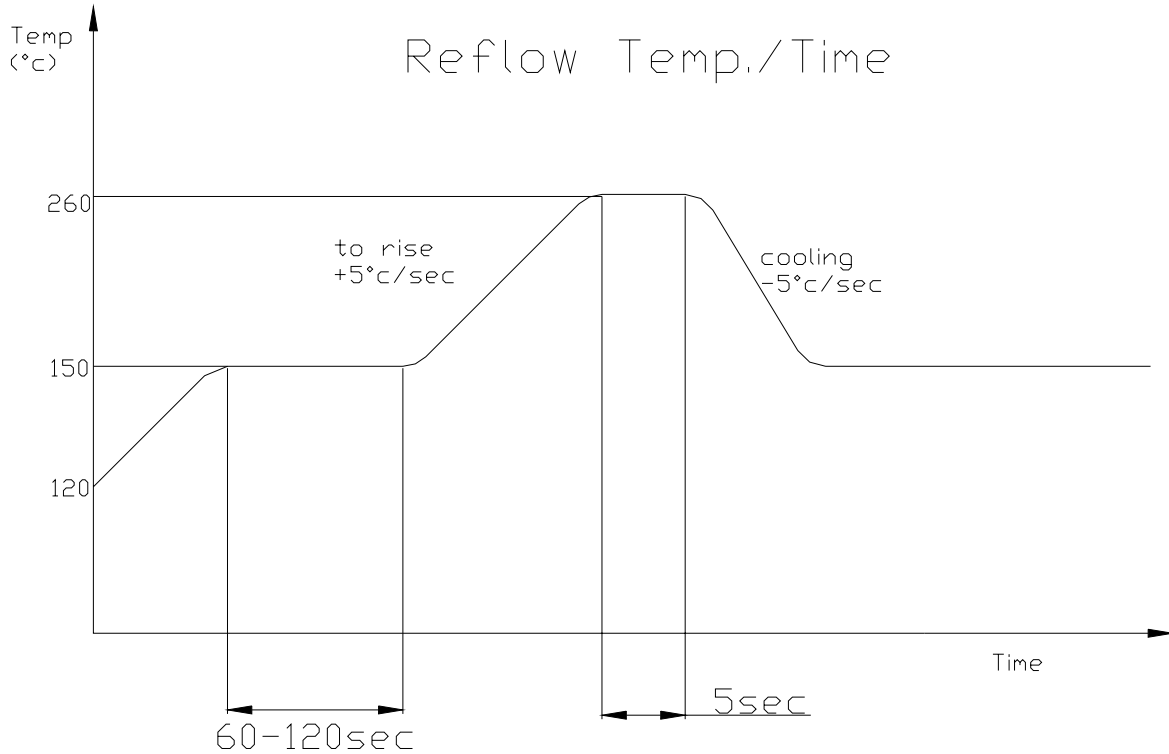

#### ■ Soldering Iron :

Basic spec is  $\leq 5$  sec when  $260^{\circ}\text{C}$ . If temperature is higher, time should be shorter ( $+10^{\circ}\text{C} \rightarrow -1\text{sec}$ ). Power dissipation of iron should be smaller than 15 W, and temperature should be controllable. Surface temperature of the device should be under  $230^{\circ}\text{C}$ .

#### ■ Rework :

1. Customer must finish rework within 5 sec under  $260^{\circ}\text{C}$ .
2. The head of iron can not touch copper foil.

# Technical Data Sheet

## 0.20" Single Digit SMD Display

**ELSS-206USRWA/S530-A3/S290**

### Reliability test items and conditions:

The reliability of products shall be satisfied with items listed below.

Confidence level : 90%

LTPD : 10%

NO	Item	Test Conditions	Test Hours/Cycle	Sample Size	Failure Judgment Criteria	Ac/Re
1	Reflow Soldering	Temp:260°C±5°C 5~10 Sec	6 Min	22 PCS	$I_v \leq I_{vt} * 0.5$ or $V_F \geq U$ or $V_F \leq L$	0/1
2	Temperature Cycle	H : +100°C 15min § 5min L : -40°C 15min	300 Cycles	22 PCS		0/1
3	Thermal Shock	H : +100°C 5min § 10 sec L : -10°C 5min	300 Cycles	22 PCS		0/1
4	High Temperature Storage	TEMP:105°C	1000 Hrs	22PCS		0/1
5	Low Temperature Storage	TEMP:-40°C	1000 Hrs	22 PCS		0/1
6	DC Operating Life	TEMP:25°C I <sub>f</sub> = 10mA	1000 Hrs	22 PCS		0/1
7	High Temperature / High Humidity	85°C / 85% RH	1000 Hrs	22 PCS		0/1

Note : I<sub>vt</sub> : The test I<sub>v</sub> value of the chip before the reliability test

I<sub>v</sub> : The test value of the chip that has completed the reliability test

U : Upper Specification Limit

L : Lower Specification Limit

# Technical Data Sheet

## 0.20" Single Digit SMD Display

**ELSS-206USRWA/S530-A3/S290**

### Package Dimensions

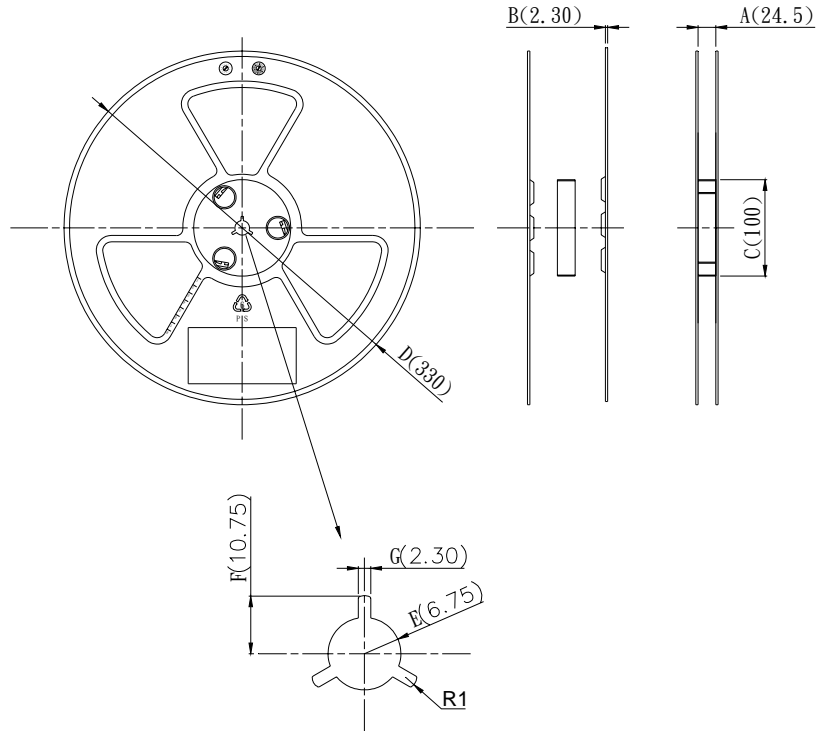

### Taping Dimensions

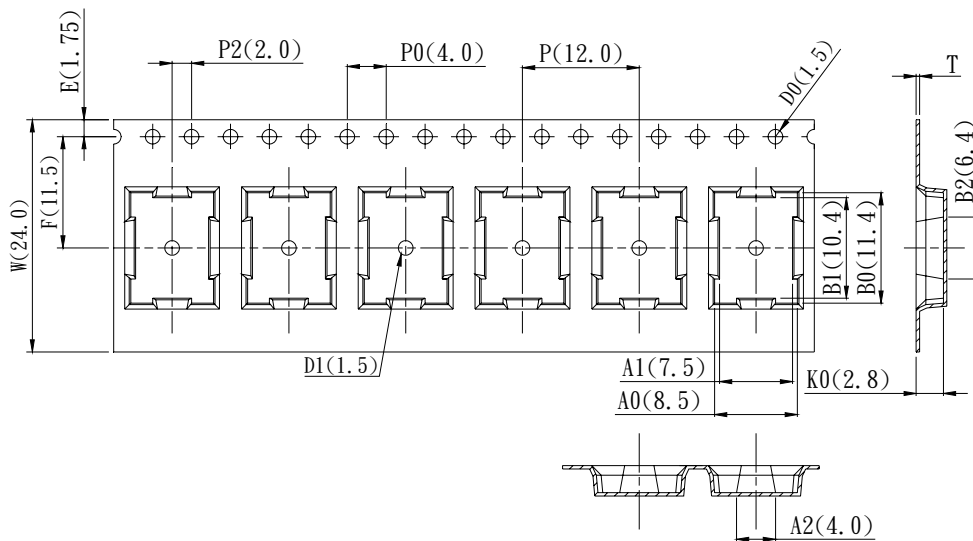



# Technical Data Sheet

## 0.20" Single Digit SMD Display

**ELSS-206USRWA/S530-A3/S290**

### Packing Quantity Specification

1500PCS/Roll · 1Roll/Small box, 7Small boxes/Box

### Label Form Specification

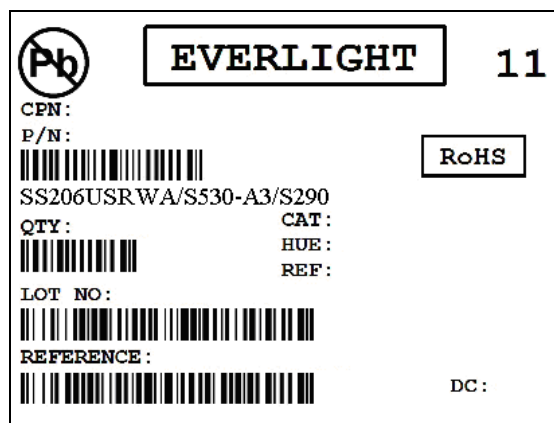

CPN: Customer's Production Number

P/N : Production Number

QTY: Packing Quantity

CAT: Ranks

HUE: Space

REF: Reference

LOT No: Lot Number

DC: Year and weekly

REFERENCE: Label identify code

### Notes

1. Above specification may be changed without notice. EVERLIGHT will reserve authority on material change for above specification.
2. When using this product, please observe the absolute maximum ratings and the instructions for using outlined in these specification sheets. EVERLIGHT assumes no responsibility for any damage resulting from use of the product which does not comply with the absolute maximum ratings and the instructions included in these specification sheets.
3. These specification sheets include materials protected under copyright of EVERLIGHT Corporation. Please don't reproduce or cause anyone to reproduce them without EVERLIGHT's consent.

EVERLIGHT ELECTRONICS CO., LTD.

Office: No 25, Lane 76, Sec 3, Chung Yang Rd,

Tucheng, Taipei 236, Taiwan, R.O.C

Tel: 886-2-2267-2000, 2267-9936

Fax: 886-2-2267-6244, 2267-6189, 2267-6306

<http://www.everlight.com>