

MOLEX P/N	CONTACT PLATING	DIM "B"	P.C.B THICKNESS
87715-9900	GOLD 15	3.00	2.36
87715-9901	MICROINCH	2.54	1.58
87715-9922	GOLD 30	2.54	1.58
87715-9923	MICROINCH	3.00	2.36

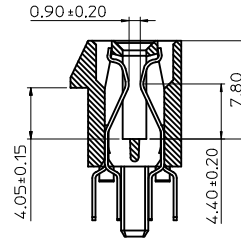

SECTION A-A

- NOTES:
- MATERIALS:
HOUSING: NYLON 46, GLASS FIBER FILLED UL94V-0
COLOR:BLACK
TERMINAL: PHOSPHOR BRONZE
 - PLATING:
TERMINAL :
CONTACT AREA: SEE TABLE
SOLDER TAIL: TIN, THICKNESS = 100 MICROINCH MIN.
UNDER PLATING: NICKEL OVERALL
 - WEEK CODE: XX(YEAR), XX(WEEK), X(LOCATION)
 - PRODUCT SPECIFICATION REFER TO PS-87715-200
 - PACKAGE SPECIFICATION REFER TO PK-87715-201
 - TEST SUMMARY: REFER TO TS-87715-209
 - CHAMFER EDGES MUST BE FREE OF CUTTING BURRS.
 - LEAD FREE AND ROHS COMPLIANCE PRODUCT.

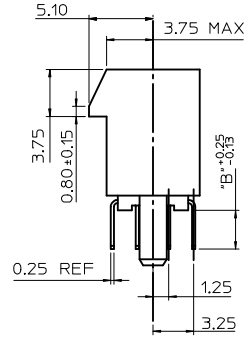
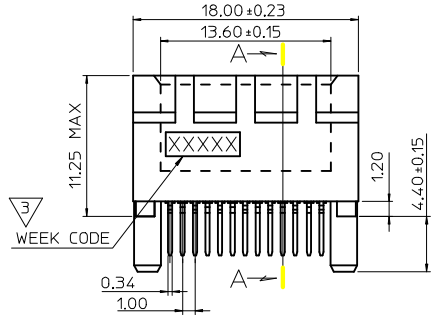
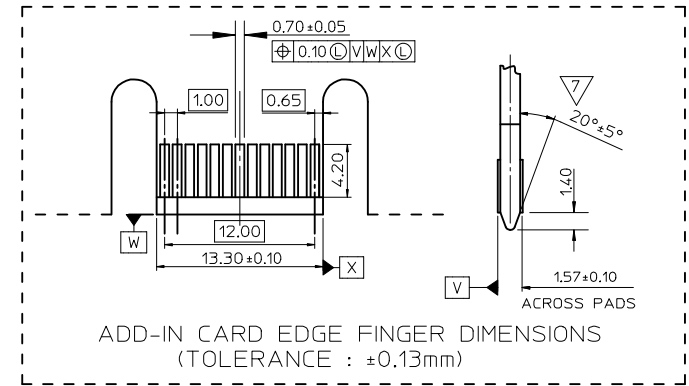
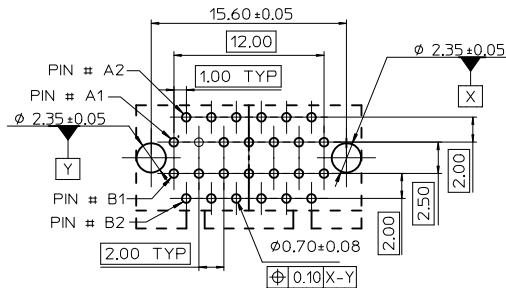
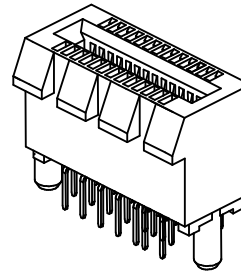
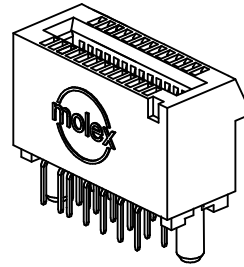
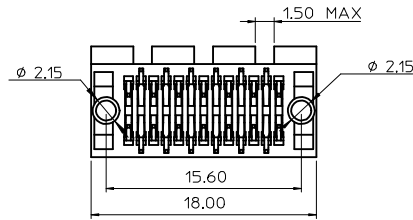

RECOMMENDED PCB LAYOUT

NEW RELEASED EC NO: SH2006-0194 DRAWN:ALL IN 2006/04/18 CHKD: 2006/04/18 APPR:WMSCHANG 2006/04/18	QUALITY SYMBOLS ▽=0 ◁=0	GENERAL TOLERANCES (UNLESS SPECIFIED)		DIMENSION STYLE MM/IN		SCALE	DESIGN UNITS METRIC	THIRD ANGLE PROJECTION
		4 PLACES ± --- ± ---	3 PLACES ± --- ± ---	2 PLACES ± 0.25 ± ---	1 PLACE ± 0.25 ± ---	ANGULAR ± 3 °	DRAWN BY TOM	DATE 2005/03/15
A	REV	DRAFT WHERE APPLICABLE MUST REMAIN WITHIN DIMENSIONS		MATERIAL NO. SEE TABLE		MOLEX INCORPORATED		SHEET NO. 1 OF 1
		THIS DRAWING CONTAINS INFORMATION THAT IS PROPRIETARY TO MOLEX INCORPORATED AND SHOULD NOT BE USED WITHOUT WRITTEN PERMISSION		APPROVED BY WWSCHANG		DATE 2005/03/15	DOCUMENT NO. SD-87715-209	