



MICROCHIP

**PIC18F87J72
Evaluation Board
User's Guide**

Note the following details of the code protection feature on Microchip devices:

- Microchip products meet the specification contained in their particular Microchip Data Sheet.
- Microchip believes that its family of products is one of the most secure families of its kind on the market today, when used in the intended manner and under normal conditions.
- There are dishonest and possibly illegal methods used to breach the code protection feature. All of these methods, to our knowledge, require using the Microchip products in a manner outside the operating specifications contained in Microchip's Data Sheets. Most likely, the person doing so is engaged in theft of intellectual property.
- Microchip is willing to work with the customer who is concerned about the integrity of their code.
- Neither Microchip nor any other semiconductor manufacturer can guarantee the security of their code. Code protection does not mean that we are guaranteeing the product as "unbreakable."

Code protection is constantly evolving. We at Microchip are committed to continuously improving the code protection features of our products. Attempts to break Microchip's code protection feature may be a violation of the Digital Millennium Copyright Act. If such acts allow unauthorized access to your software or other copyrighted work, you may have a right to sue for relief under that Act.

Information contained in this publication regarding device applications and the like is provided only for your convenience and may be superseded by updates. It is your responsibility to ensure that your application meets with your specifications. MICROCHIP MAKES NO REPRESENTATIONS OR WARRANTIES OF ANY KIND WHETHER EXPRESS OR IMPLIED, WRITTEN OR ORAL, STATUTORY OR OTHERWISE, RELATED TO THE INFORMATION, INCLUDING BUT NOT LIMITED TO ITS CONDITION, QUALITY, PERFORMANCE, MERCHANTABILITY OR FITNESS FOR PURPOSE. Microchip disclaims all liability arising from this information and its use. Use of Microchip devices in life support and/or safety applications is entirely at the buyer's risk, and the buyer agrees to defend, indemnify and hold harmless Microchip from any and all damages, claims, suits, or expenses resulting from such use. No licenses are conveyed, implicitly or otherwise, under any Microchip intellectual property rights.

Trademarks

The Microchip name and logo, the Microchip logo, dsPIC, KEELOQ, KEELOQ logo, MPLAB, PIC, PICmicro, PICSTART, PIC³² logo, rPIC and UNI/O are registered trademarks of Microchip Technology Incorporated in the U.S.A. and other countries.

FilterLab, Hampshire, HI-TECH C, Linear Active Thermistor, MXDEV, MXLAB, SEEVAL and The Embedded Control Solutions Company are registered trademarks of Microchip Technology Incorporated in the U.S.A.

Analog-for-the-Digital Age, Application Maestro, chipKIT, chipKIT logo, CodeGuard, dsPICDEM, dsPICDEM.net, dsPICworks, dsSPEAK, ECAN, ECONOMONITOR, FanSense, HI-TIDE, In-Circuit Serial Programming, ICSP, Mindi, MiWi, MPASM, MPLAB Certified logo, MPLIB, MPLINK, mTouch, Omniscient Code Generation, PICC, PICC-18, PICDEM, PICDEM.net, PICkit, PICtail, REAL ICE, rfLAB, Select Mode, Total Endurance, TSHARC, UniWinDriver, WiperLock and ZENA are trademarks of Microchip Technology Incorporated in the U.S.A. and other countries.

SQTP is a service mark of Microchip Technology Incorporated in the U.S.A.

All other trademarks mentioned herein are property of their respective companies.

© 2011, Microchip Technology Incorporated, Printed in the U.S.A., All Rights Reserved.

 Printed on recycled paper.

ISBN: 978-1-61341-304-3

QUALITY MANAGEMENT SYSTEM
CERTIFIED BY DNV
== ISO/TS 16949:2009 ==

Microchip received ISO/TS-16949:2002 certification for its worldwide headquarters, design and wafer fabrication facilities in Chandler and Tempe, Arizona; Gresham, Oregon and design centers in California and India. The Company's quality system processes and procedures are for its PIC[®] MCUs and dsPIC[®] DSCs, KEELOQ[®] code hopping devices, Serial EEPROMs, microperipherals, nonvolatile memory and analog products. In addition, Microchip's quality system for the design and manufacture of development systems is ISO 9001:2000 certified.



PIC18F87J72 EVALUATION BOARD USER'S GUIDE

Table of Contents

Preface	5
Introduction.....	5
Document Layout	6
Recommended Reading.....	7
The Microchip Web Site	7
Customer Support	8
Document Revision History	8
Chapter 1. Product Overview	
1.1 Introduction	9
1.2 PIC18F87J72 Evaluation Board Functionality and Features	9
1.3 PIC18F87J72 EVALUATION BOARD KIT CONTENTS	10
Chapter 2. Hardware Description	
2.1 Introduction	11
Chapter 3. PIC18F87J72 Evaluation Board Features	
3.1 Introduction	17
Chapter 4. PIC18F87J72 Evaluation Board Firmware Flowchart	
4.1 Introduction	23
Chapter 5. PIC18F87J72 Evaluation Board Lab Test Results	
5.1 Introduction	31
Chapter 6. PIC18F87J72 Evaluation Board GUI	
6.1 Introduction	35

PIC18F87J72 EVALUATION BOARD USER'S GUIDE

Appendix A. Schematics and Layouts

A.1 Introduction	37
A.2 Board – Schematic 1	38
A.3 Board – Schematic 2	39
A.4 Board – Schematic 3	40
A.5 Board – Schematic 4	41
A.6 Board – PCB Front Page	42
A.7 Board – PCB Top Silk	43
A.8 Board – PCB Top Layer	44
A.9 Board – PCB Bottom Layer	45
A.10 Board – PCB Bottom Silk	46
A.11 Board – PCB L1 Ground	47
A.12 Board – PCB L2 VDD	48

Appendix B. Bill of Materials (BOM)

Worldwide Sales and Service	52
-----------------------------------	----



PIC18F87J72 EVALUATION BOARD USER'S GUIDE

Preface

NOTICE TO CUSTOMERS

All documentation becomes dated, and this manual is no exception. Microchip tools and documentation are constantly evolving to meet customer needs, so some actual dialogs and/or tool descriptions may differ from those in this document. Please refer to our web site (www.microchip.com) to obtain the latest documentation available.

Documents are identified with a "DS" number. This number is located on the bottom of each page, in front of the page number. The numbering convention for the DS number is "DSXXXXA", where "XXXX" is the document number and "A" is the revision level of the document.

For the most up-to-date information on development tools, see the MPLAB® IDE on-line help. Select the Help menu, and then Topics to open a list of available on-line help files.

INTRODUCTION

This chapter contains the general information that will be useful to know before using the PIC18F87J72 Evaluation Board. Items discussed in this chapter include:

- Document Layout
- Recommended Reading
- The Microchip Web Site
- Customer Support
- Document Revision History

PIC18F87J72 Evaluation Board User's Guide

DOCUMENT LAYOUT

This document describes how to use the PIC18F87J72 Evaluation Board as a development tool to emulate and debug firmware on a target board. The manual layout is as follows:

- **Chapter 1. “Product Overview”** – Provides a brief overview of the PIC18F87J72 Evaluation Board, its features and uses.
- **Chapter 2. “Hardware Description”** – Provides a detailed description of the PIC18F87J72 Evaluation Board hardware features.
- **Chapter 3. “PIC18F87J72 Evaluation Board Features”** – Provides details on how to use and configure the PIC18F87J72 Evaluation Board.
- **Chapter 4. “PIC18F87J72 Evaluation Board Firmware Flowchart”** – Provides the flow charts for various functions and routines in the firmware.
- **Chapter 5. “PIC18F87J72 Evaluation Board Lab Test Results”** – Provides the various lab test results obtained when working on a debugging environment using MPLAB® IDE.
- **Chapter 6. “PIC18F87J72 Evaluation Board GUI”** – Provides details on the Graphical User Interface (GUI) used for plotting the various signals in time and frequency domain for spectral analysis.
- **Appendix A. “Schematics and Layouts”** – Provides schematic and board layouts of the PIC18F87J72 Evaluation Board.
- **Appendix B. “Bill of Materials (BOM)”** – Provides details of all the components with part numbers and designators used for the PIC18F87J72 Evaluation Board.

RECOMMENDED READING

This user's guide describes how to use PIC18F87J72 Evaluation Board. Other useful documents are listed below. The following Microchip documents are available and recommended as supplemental reference resources.

MPLAB® IDE Simulator, Editor User's Guide (DS51025)

Refer to this document for more information on installation and implementation of the MPLAB Integrated Development Environment (IDE) software.

THE MICROCHIP WEB SITE

Microchip provides online support through our web site at www.microchip.com. This web site is used as a means to make files and information easily available to customers. Accessible by using your favorite Internet browser, the web site contains the following information:

- **Product Support** – Data sheets and errata, application notes and sample programs, design resources, user's guides and hardware support documents, latest software releases and archived software
- **General Technical Support** – Frequently Asked Questions (FAQs), technical support requests, online discussion groups, Microchip consultant program member listing
- **Business of Microchip** – Product selector and ordering guides, latest Microchip press releases, listing of seminars and events, listings of Microchip sales offices, distributors and factory representatives

PIC18F87J72 Evaluation Board User's Guide

CUSTOMER SUPPORT

Users of Microchip products can receive assistance through several channels:

- Distributor or Representative
- Local Sales Office
- Field Application Engineer (FAE)
- Technical Support
- Development Systems Information Line

Customers should contact their distributor, representative or field application engineer (FAE) for support. Local sales offices are also available to help customers. A listing of sales offices and locations is included in the back of this document.

Technical support is available through the web site at: <http://support.microchip.com>

DOCUMENT REVISION HISTORY

Revision A (June 2011)

This is the initial release of this document.

Chapter 1. Product Overview

1.1 INTRODUCTION

This chapter provides an overview of the PIC18F87J72 Evaluation Board. This board is used as a development tool and as evaluation kit for PIC18F87J72 based applications.

Topics discussed in this chapter include:

- Development Kit Contents
- Evaluation Board Functionality and Features

1.2 PIC18F87J72 EVALUATION BOARD FUNCTIONALITY AND FEATURES

The PIC18F87J72 Evaluation Board provides a platform for developing and evaluating applications which are based on the PIC18F87J72 device. These applications can range from accurate measurement of low signals like an output signal of a load cell to processing of information for metering and other metrology applications like energy metering, heatmeter and so on.

The PIC18F87J72 microcontroller has an 8-bit core processor along with many advanced peripherals like 12-bit SAR-based ADC, two 24-bit delta sigma ADCs and Charge Time Measurement unit (CTMU) for temperature measurement or implementation of touch keys.

PIC18F87J72 also has built-in Real Time Clock and Calendar (RTCC) with calibration registers for time stamping the measured data, and a Liquid Crystal Display (LCD) driver for a display up to 132 pixels.

The PIC18F87J72 Evaluation Board has the following features to develop and test user applications:

- Easy connection for low and high voltage signals. Signals from variety of sensors can be connected to this board.
- Touch keys to select different parameters of the of the 24-bit Delta Sigma ADC, like Over Sampling Ratio (OSR), Resolution, and Channel gain.
- Direct LCD display, driven from the COM/SEG pins of PIC18F87J72
- Real Time Clock
- Temperature Measurement option with CTMU

The PIC18F87J72 Evaluation Board can be connected to the GUI, supplied along with the board, to analyze the synchronous sampling, 24-bit, delta sigma ADCs. The ADCs have 90 dB SINAD and -104dB THD (up to the 35th harmonic) for each channel, enabling highly accurate energy metering and other low signal level designs. With less than 10 mVRMS output noise and a programmable gain amplifier of up to 32 V/V, these 24-bit ADCs are capable of interfacing to a large variety of small signal sensors, as well as voltage and current sensors, including shunts, Current Transformers (CT), Rogowski coils, Hall Effect sensors and load cells.

PIC18F87J72 Evaluation Board User's Guide

1.3 PIC18F87J72 EVALUATION BOARD KIT CONTENTS

This PIC18F87J72 Evaluation Board kit includes:

- PIC18F87J72 Evaluation Board
- Pre-Programmed PIC18F87J72 microcontroller on board
- MCP2200 device on board
- GUI
- LAB VIEW installation software for the GUI
 - Visa 441 runtime
 - LVRTE86std
- Mini Universal Serial Bus (USB) connecting cable

Chapter 2. Hardware Description

2.1 INTRODUCTION

This chapter describes the various sections of the hardware present on the evaluation board. It also describes the different configurations possible for operating the evaluation board, depending upon the input voltage and current specifications. Figure 2-1 shows the overall layout of the PIC18F87J72 Evaluation Board where the different hardware sections are indicated by numbers. Table 2-1 lists the descriptions for each hardware component.

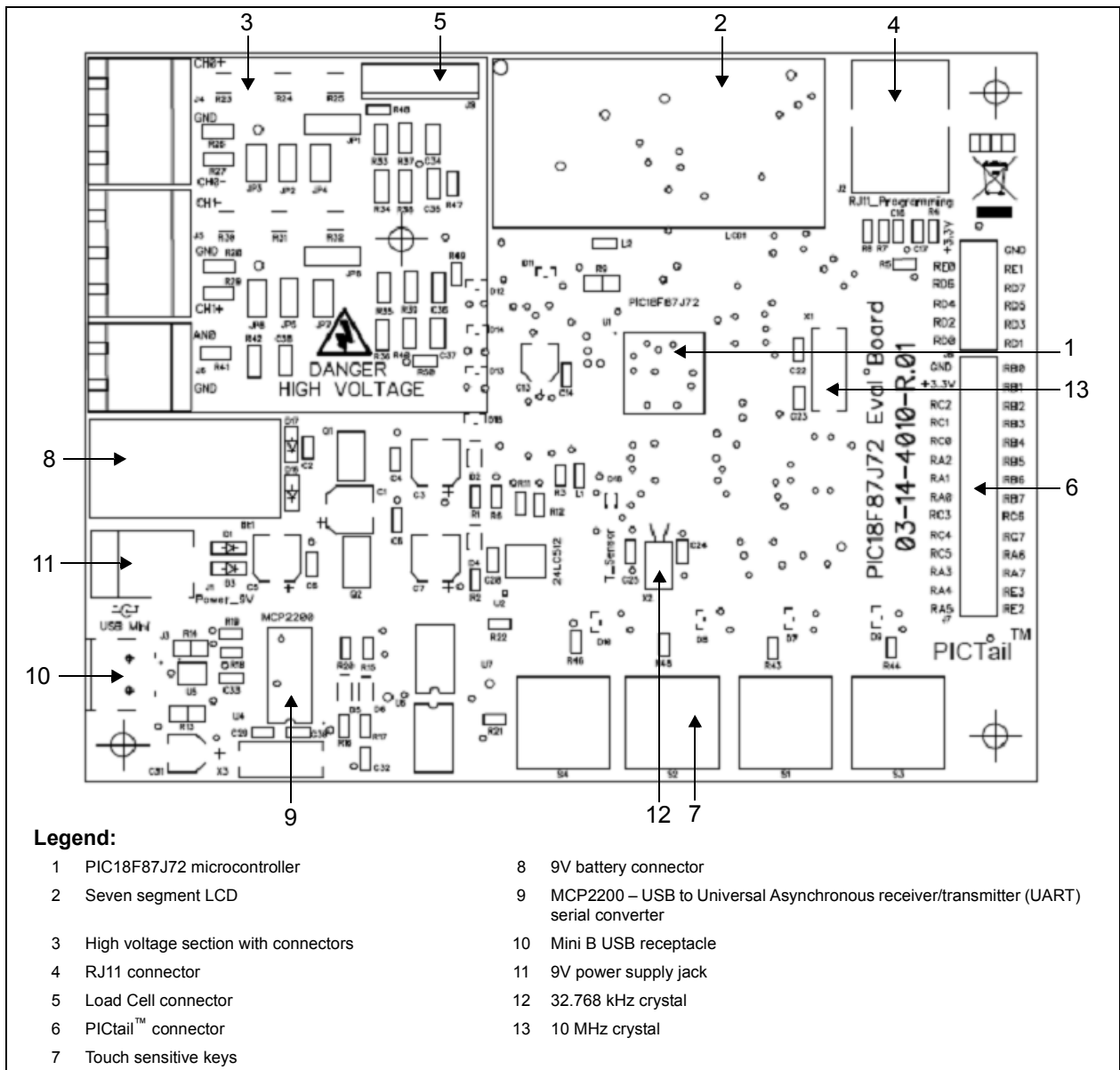

FIGURE 2-1: Layout of the PIC18F87J72 Evaluation Board.

PIC18F87J72 Evaluation Board User's Guide

TABLE 2-1: BOARD LAYOUT AND COMPONENTS

SI NO	Section or Component	Functionality
1	PIC18F87J72 microcontroller	Main controller for all functions on the board
2	Seven segment LCD	To display time and other configuration features like OSR, Gain, Bit Width
3	High voltage section with connectors	For connecting universal input voltage to the board (when not using 9V supply or battery)
4	RJ11 connector	For debugging and programming purpose
5	Load Cell connector	Optional provision to connect an external load cell output to the ADC input channels
6	PICtail™ connector	To connect to other application-specific daughter cards
7	Touch sensitive keys	Touch sense switches for changing configuration of Sigma-Delta ADC
8	9V battery connector	To connect a 9V battery when powering the board through it
9	MCP2200 – USB to UART serial converter	To communicate with the GUI
10	Mini B USB receptacle	To connect the USB port of the computer to the evaluation board
11	9V power supply jack	9V power supply to the board
12	32.768 kHz crystal	Clock to the internal Real-Time Clock and Calendar (RTCC)
13	10 MHz crystal	External Clock to the main controller

2.1.1 PIC18F87J72 Evaluation Board Jumper Settings

Table 2-2 shows the various jumpers available on the PIC18F87J72 Evaluation Board. By connecting the jumper pins appropriately, different configurations can be achieved on the board. Care must be taken regarding the voltage level before placing these jumpers. Further sections in this document describe what precautions need to be ensured while connecting these jumpers.

TABLE 2-2: JUMPERS ON THE EVALUATION BOARD

SI NO	Device	Description
1	JP1	Selection between high voltage and low voltage input on channel CH0
2	JP2	To ground Pin 1 of J4
3	JP3	Used for burden connections when CT output is connected to J4
4	JP4	To ground Pin 3 of J4
5	JP5	To ground Pin 1 of J5
6	JP6	Used for burden connections when CT output is connected to J5
7	JP7	To ground Pin 3 of J5
8	JP8	Selection between high voltage and low voltage input on channel CH1

2.1.2 Measurement of High Voltages

The circuit diagrams in the schematics section of **Appendix A. “Schematics and Layouts”**, provide details on the resistor values used for dividing the network of the input voltage. Table 2-3 provides a quick reference to resistor values in the high voltage section.

TABLE 2-3: RESISTORS FOR HIGH VOLTAGE MEASUREMENT

Register	Value (K Ω)
R23 and R30	330
R24 and R31	330
R25 and R32	120
R33 and R35	1
R37 and R39	1

When measuring a high voltage signal on the input terminals of channels CH0 and CH1, refer to Table 2-4 and Table 2-5. These tables provide the configuration of jumpers, along with the amplitude of the voltage available at the various points. The high voltage can be in the universal range of input voltage ranging from 85-265 Volts_{rms} (Vrms) at 50 Hz or 60 Hz.

TABLE 2-4: JUMPER SETTINGS FOR HIGH VOLTAGE MEASUREMENT ON CH0

CH0 Jumper Position					ADC		Remark
Voltage (Vrms)	JP1	JP2	JP3	JP4	ADC I/P (Vrms)	ADC I/P (Vpeak)	
80	Short 1-2	Open	Open	Short	0.10230	0.14468	Internal Gain of 2 can be used for better resolution
110	Short 1-2	Open	Open	Short	0.14066	0.19893	
220	Short 1-2	Open	Open	Short	0.28133	0.39786	
270	Short 1-2	Open	Open	Short	0.34527	0.48828	
280	Short 1-2	Open	Open	Short	0.35806	0.50637	Max Differential ADC I/P is 0.5V

TABLE 2-5: JUMPER SETTINGS FOR HIGH VOLTAGE MEASUREMENT ON CH1

CH1 Jumper Position					ADC		Remark
Voltage (Vrms)	JP8	JP5	JP6	JP7	ADC I/P (Vrms)	ADC I/P (Vpeak)	
80	Short 1-2	Open	Open	Short	0.10230	0.14468	Internal Gain of 2 can be used for better resolution
110	Short 1-2	Open	Open	Short	0.14066	0.19893	
220	Short 1-2	Open	Open	Short	0.28133	0.39786	
270	Short 1-2	Open	Open	Short	0.34527	0.48828	
280	Short 1-2	Open	Open	Short	0.35806	0.50637	Max Differential ADC I/P is 0.5V

- Note 1:** The precautions given need to be strictly adhered to, in order to avoid any damage to the evaluation board and prevent electric shock hazard.
- 2:** Input high voltage AC signal can be applied between pins 1 and 2 of the connector J4 or J5.
 - 3:** The resistors R26 and R27 should not be populated when pins 1 and 2 of J4 are connected to a high voltage.
 - 4:** The resistors R28 and R29 should not be populated when pins 1 and 2 of J5 are connected to a high voltage.
 - 5:** The resistors R26, R27, R28 and R29 can be used only when CT outputs are connected to the connectors J4 and J5. In this case, these resistors act as a burden resistor to the CT secondary winding.

PIC18F87J72 Evaluation Board User's Guide

2.1.3 Measurement of Low Voltages

The circuit diagrams in the schematics section of **Appendix A. "Schematics and Layouts"**, provide details on the resistor values used for the low voltage circuit. Table 2-6 provides a quick reference to resistor values in the low voltage section.

TABLE 2-6: RESISTORS FOR LOW VOLTAGE MEASUREMENT

Register	Value (K Ω)
R34 and R36	1
R33 and R35	1
R37 and R39	1
R38 and R40	1

When measuring a low voltage signal on the input terminals of channels CH0 and CH1, refer to Table 2-7 and Table 2-8. These tables provide the configuration of jumpers, along with the amplitude of the voltage available at the various points. The low voltage signal can be either an AC signal, a DC signal or a signal of any arbitrary wave shape.

TABLE 2-7: JUMPER SETTINGS FOR LOW VOLTAGE MEASUREMENT ON CH0

CH0 Jumper Position					ADC		Remark
Voltage (Vrms)	JP1	JP2	JP3	JP4	ADC I/P (Vrms)	ADC I/P (Vpeak)	
0.1	Short 2-3	Open	Open	Short	0.05000	0.05000	Internal Gain of 2 can be used for better resolution
0.2	Short 2-3	Open	Open	Short	0.10000	0.10000	
0.5	Short 2-3	Open	Open	Short	0.25000	0.25000	
1	Short 2-3	Open	Open	Short	0.50000	0.50000	
1.1	Short 2-3	Open	Open	Short	0.55000	0.55000	Max Differential ADC I/P is 0.5V

TABLE 2-8: JUMPER SETTINGS FOR LOW VOLTAGE MEASUREMENT ON CH1

CH1 Jumper Position					ADC		Remark
Voltage (Vrms)	JP8	JP5	JP6	JP7	ADC I/P (Vrms)	ADC I/P (Vpeak)	
0.1	Short 2-3	Open	Open	Short	0.05000	0.05000	Internal Gain of 2 can be used for better resolution
0.2	Short 2-3	Open	Open	Short	0.10000	0.10000	
0.5	Short 2-3	Open	Open	Short	0.25000	0.25000	
1	Short 2-3	Open	Open	Short	0.50000	0.50000	
1.1	Short 2-3	Open	Open	Short	0.55000	0.55000	Max Differential ADC I/P is 0.5V

Note 1: Input low voltage signal can be applied between pins 1 and 2 of the connector J4 or J5.

2.1.4 Measurement of Current Signals

The circuit diagrams in the schematics section of **Appendix A. “Schematics and Layouts”**, provide details on the resistor values used for the current measurement circuit. Table 2-9 provides a quick reference to resistor values while measuring the current signals. The output of Current Transformers (CTs) can be connected to the input connector pins.

TABLE 2-9: RESISTORS FOR LOW VOLTAGE MEASUREMENT

Register	Value (KΩ)
R26 and R28	0.063
R27 and R29	0.063
R34 and R36	1
R33 and R35	1
R37 and R39	1
R38 and R40	1

When measuring a current signal on the input terminals of channels CH0 and CH1, refer to Table 2-10 and Table 2-11. These tables provide the configuration of jumpers, along with the amplitude of the voltage available at the various points.

TABLE 2-10: JUMPER SETTINGS FOR CURRENT MEASUREMENT ON CH0

CT Primary Current (Irms-A)	CH0 Jumper Position				ADC		Remark
	JP1	JP2	JP3	JP4	ADC I/P (Vrms)	ADC I/P (Vpeak)	
0.1	Short 2-3	Open	Short	Open	0.00063	0.00089	Internal Gain of 2 can be used for better resolution
0.5	Short 2-3	Open	Short	Open	0.00315	0.00445	
1	Short 2-3	Open	Short	Open	0.0063	0.00891	
10	Short 2-3	Open	Short	Open	0.063	0.08910	
20	Short 2-3	Open	Short	Open	0.126	0.17819	
30	Short 2-3	Open	Short	Open	0.189	0.26729	Max Differential ADC I/P is 0.5V

PIC18F87J72 Evaluation Board User's Guide

TABLE 2-11: JUMPER SETTINGS FOR CURRENT MEASUREMENT ON CH1

CH1 Jumper Position					ADC		Remark
CT Primary Current (Irms-A)	JP1	JP2	JP3	JP4	ADC I/P (Vrms)	ADC I/P (Vpeak)	
0.1	Short 2-3	Open	Short	Open	0.00063	0.00089	Internal Gain of 2 can be used for better resolution
0.5	Short 2-3	Open	Short	Open	0.00315	0.00445	
1	Short 2-3	Open	Short	Open	0.0063	0.00891	
10	Short 2-3	Open	Short	Open	0.063	0.08910	
20	Short 2-3	Open	Short	Open	0.126	0.17819	
30	Short 2-3	Open	Short	Open	0.189	0.26729	Max Differential ADC I/P is 0.5V

- Note 1:** The precautions given need to be strictly adhered to, in order to avoid any damage to the evaluation board and prevent electric shock hazard.
- 2:** I/P CT Secondary is connected between pins 1 and 3 of J4 and J5.
- 3:** The resistors R26, R27, R28 and R29 need to be populated. These resistors act as burden resistors for CT secondary.
- 4:** The calculations given in Table 2-10 and Table 2-11 are true for a CT ratio of 1:2500 and a burden resistance of 31.5(Ω).

Chapter 3. PIC18F87J72 Evaluation Board Features

3.1 INTRODUCTION

This chapter provides a brief description on how to use the PIC18F87J72 Evaluation Board for the measurement and analysis of various signals. It also describes the process of the demo and explains various configuration changes for observing the response using the PIC18F87J72 Evaluation Board.

Figure 3-1 shows the PIC18F87J72 Evaluation Board with the 9V supply connected to the input jack. The initial set up of the evaluation board involves connecting the supply to the input jack of the board. This provides the required supply to the evaluation board. Alternatively, the 9V battery can be connected to power the board. In addition, the USB cable from the computer is connected to the mini USB connector on the board. This is used for transmitting and receiving data to and from the board, to and from the GUI tool. The input signal can be connected to connectors J4 and J5. If the microcontroller is already programmed, then the program will start executing when the supply is turned on.

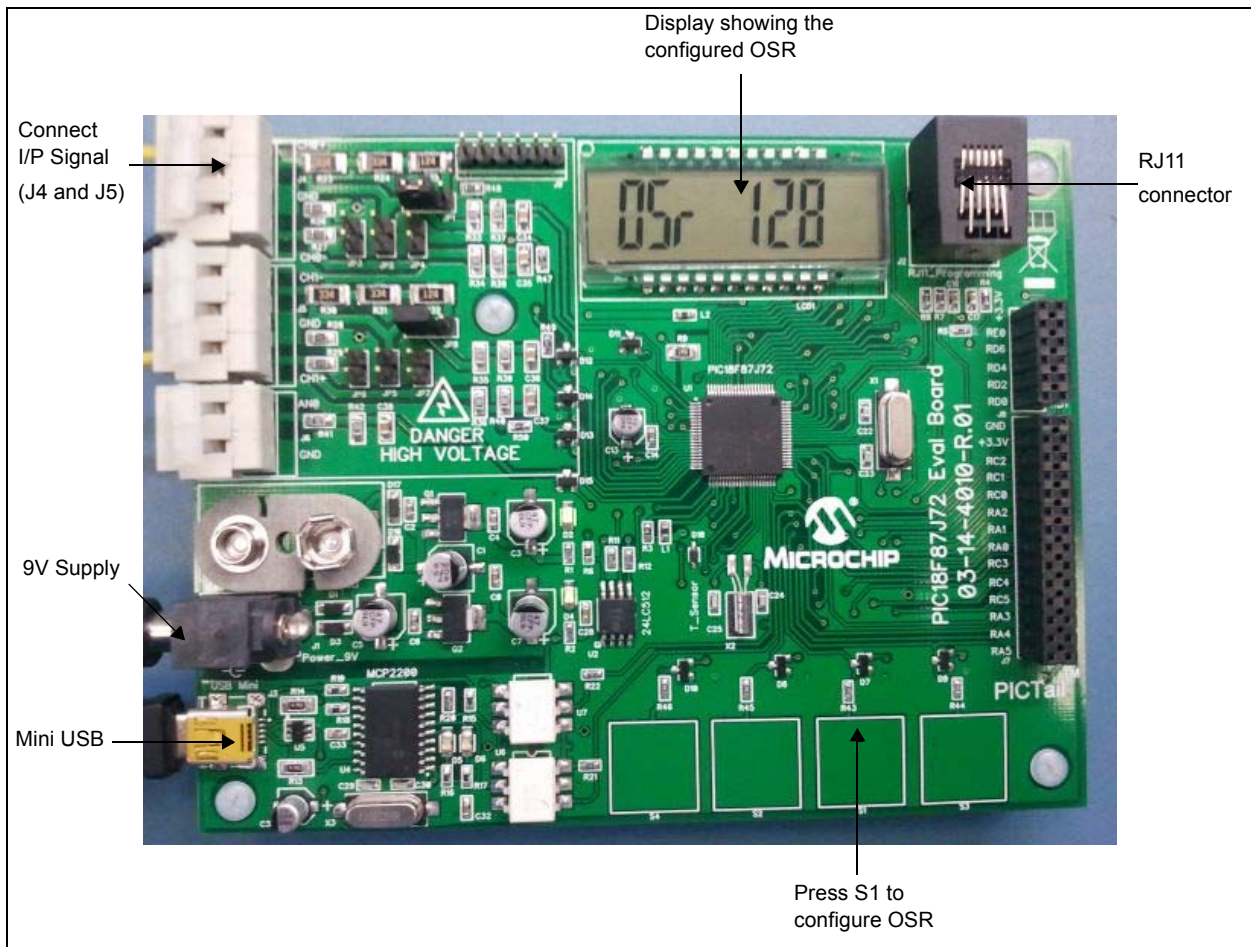

FIGURE 3-1: PIC18F87J72 Evaluation Board and OSR Configuration.

PIC18F87J72 Evaluation Board User's Guide

If the evaluation board is used in programmer mode, then the waveforms and the response can be observed on the GUI. If the evaluation board is used in debugging mode, using the MPLAB IDE, then the user can see the response on the Data Monitor and Control Interface (DMCI) window.

For debugging, the Real ICE/ICD debugger and programmer is connected to the RJ11 connector. After the software is compiled and programmed to the PIC18F87J72 device, the program can be executed. The LCD display on the board will indicate the time and the waveforms that can be observed on the GUI window or DMCI. The LCD display on the board will indicate the time. The various waveforms applied at the input can be observed on the GUI or DMCI.

Various changes to the device configuration can be done using the touch sensitive keys S1, S2, S3 and S4. The on-chip CTMU peripheral is used for all the touch-sensitive keys.

Press the key S1, to change the Over Sampling Ratio (OSR) as shown in Figure 3-1. There are four OSR configurations that can be created using S1. Each press of the key S1 will change the configuration of the sigma delta ADC with OSR values from a value of 256, 128, 64 and 32.

The time from the RTCC can also be displayed using the key S1 as shown in Figure 3-2.

The RTCC date and time can be set using the following steps:

- Press the keys S2 and S4 simultaneously to enter into the RTCC date setting mode. The date field on the LCD will start blinking.
- The date can be changed by pressing the key S4 for incrementing and S2 for decrementing. The key S1 can be used to set the day, month and year fields.
- Press the keys S1 and S2 simultaneously, to enter into the RTCC time setting mode. The time field on the LCD will start blinking.
- The time can be changed by pressing the key S4 for incrementing and S2 for decrementing. The key S1 can be used to set the hour, minute and second fields.

By pressing the key S1 repeatedly, the OSR configurations will sequentially change from 256 to 32 and then back to 256.

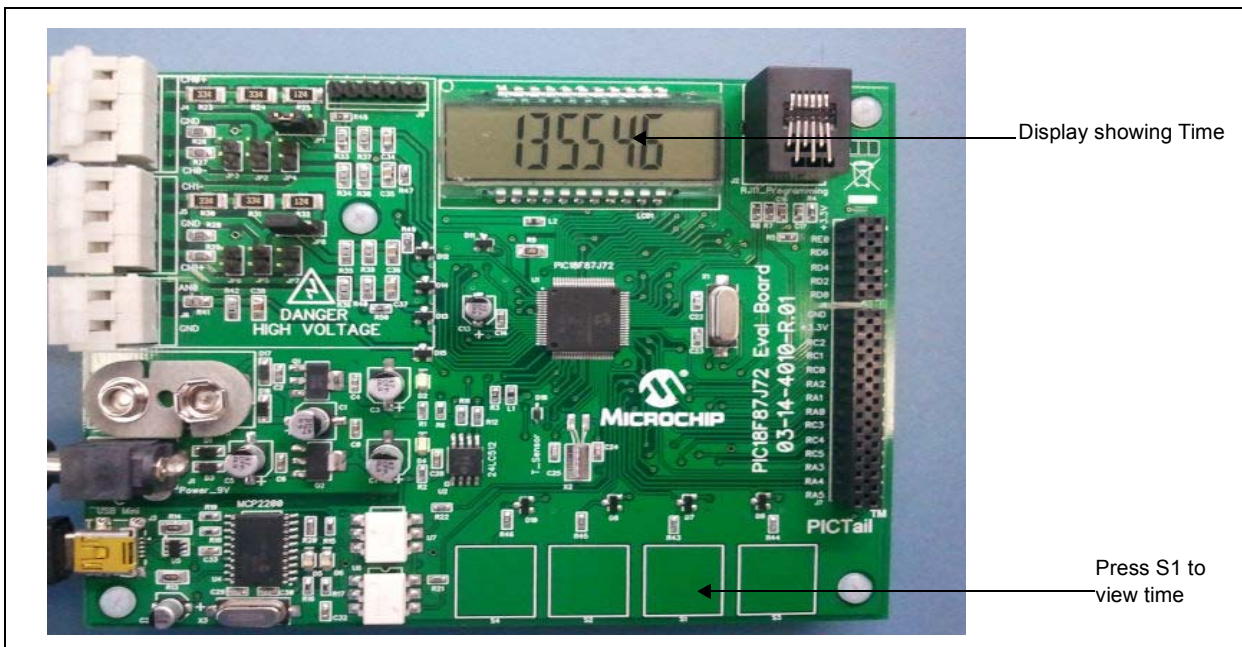

FIGURE 3-2: *Displaying Time and Date*

PIC18F87J72 Evaluation Board Features

As shown in Figure 3-3, the S2 key is used for changing the internal PGA gain of the first channel. The gains can be changed from 1 to 32 with each press of the key. When pressing the S2 key repeatedly, the gain configurations of the Sigma Delta ADC will sequentially change from 1, 2, 4, 8, 16, 32 and then back to 1.

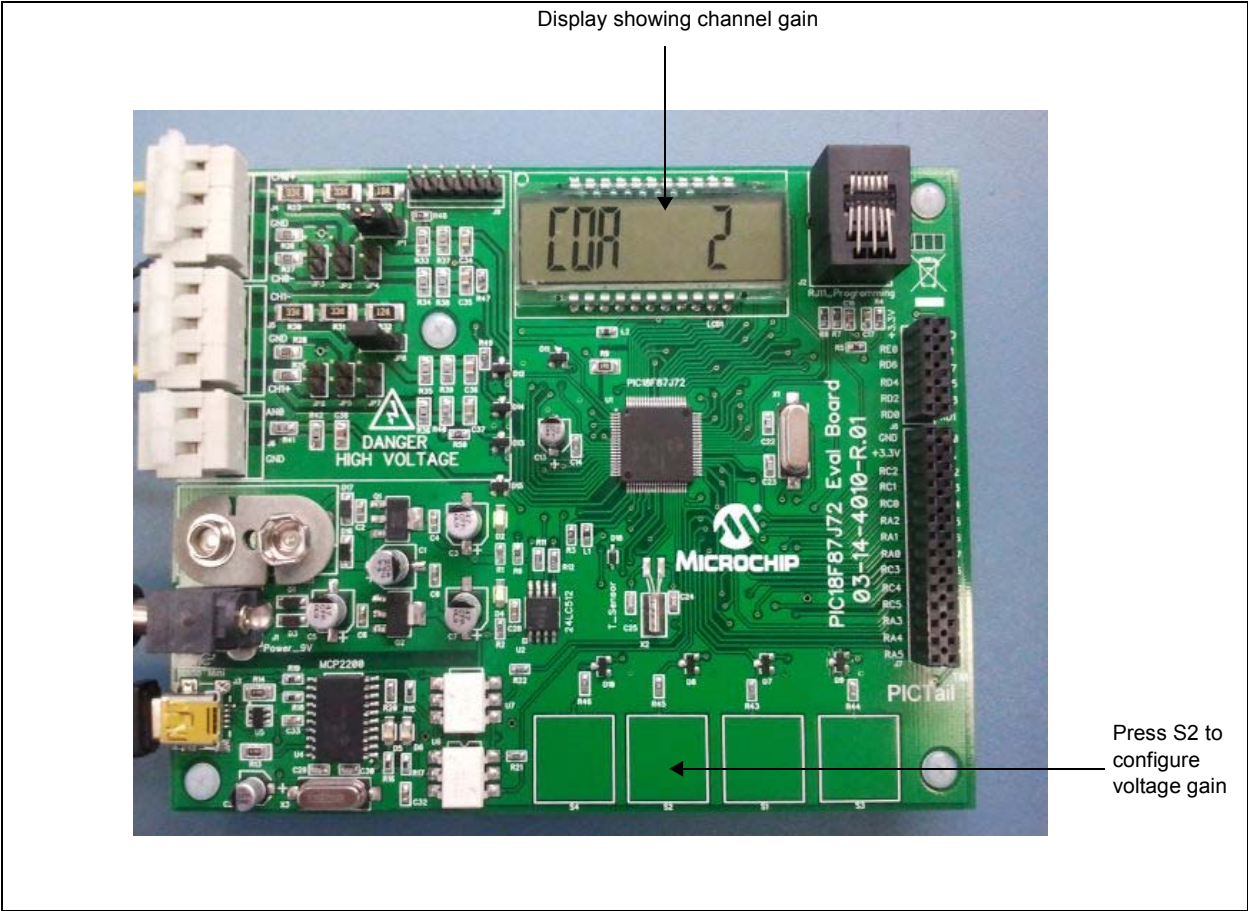

FIGURE 3-3: Configuring Internal PGA Gain for voltage channel.

PIC18F87J72 Evaluation Board User's Guide

Figure 3-4 shows the function of the S3 key, which is used to change the internal gain of the second input channel. The gains can be changed from 1 to 32 with each press of the key. When pressing the S3 key repeatedly, the gain configurations of the Sigma Delta ADC will sequentially change from 1, 2, 4, 8, 16, 32 and then back to 1.

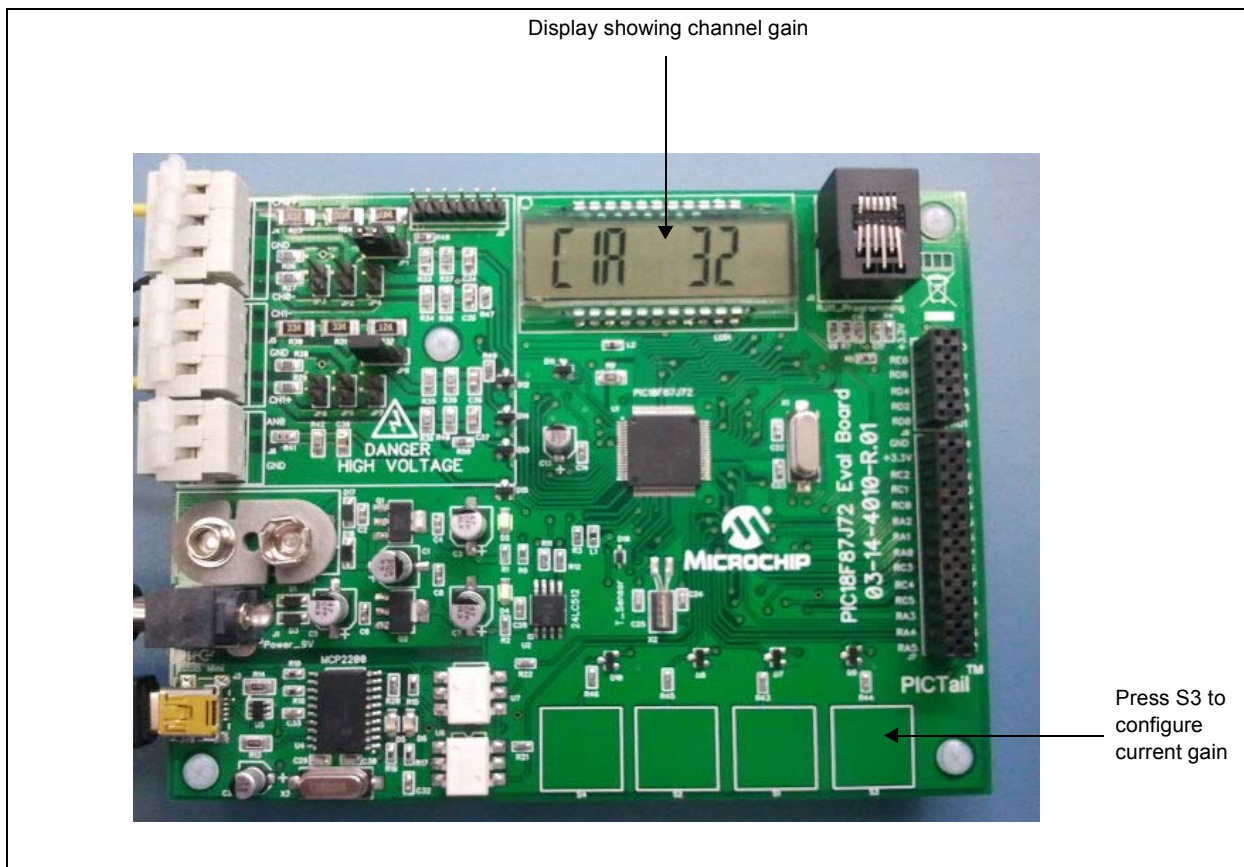

FIGURE 3-4: Configuring Internal PGA Gain for Current Channel.

PIC18F87J72 Evaluation Board Features

Figure 3-5 shows the function of the S4 key, which is used to change the bit width of the ADC conversion. Two configurations of the ADC bits are possible, either 16-bit or 24-bit. When the S4 key is pressed repeatedly, the bits toggle between 16 and 24-bit width.

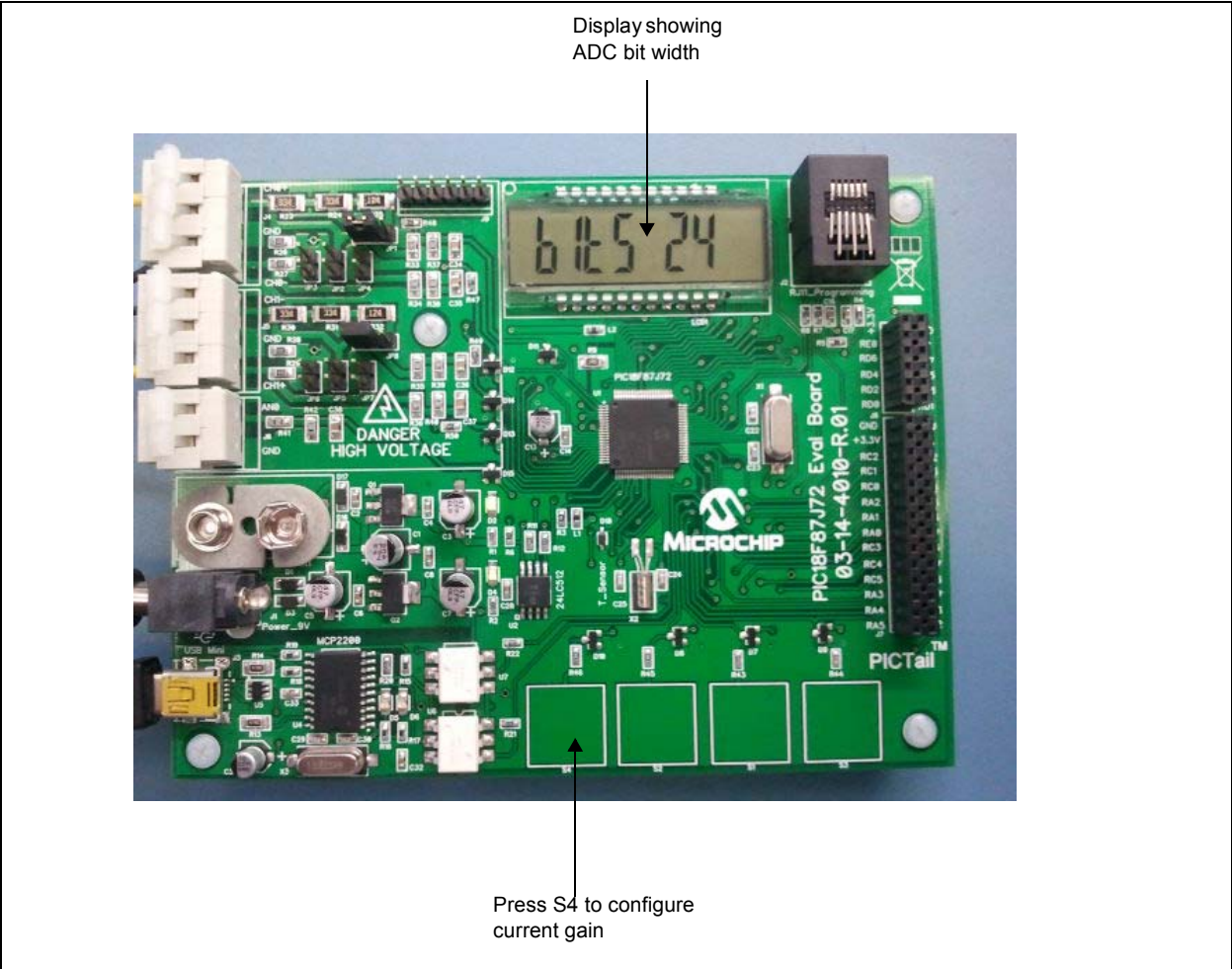

FIGURE 3-5: Configuring the Number of Bits.

PIC18F87J72 Evaluation Board User's Guide

NOTES:

Chapter 4. PIC18F87J72 Evaluation Board Firmware Flowchart

4.1 INTRODUCTION

This chapter provides the flowcharts describing the functions and routines implemented in the PIC18F87J72 Evaluation Board firmware.

Figures 4-1 – 4-6 show the flow of the following routines:

- Main routine (see Figure 4-1)
- Touch Key press routines (see Figure 4-2)
- Time display routines (see Figure 4-2)
- OSR switching routines (see Figure 4-2)
- Channel CH0 Gain switching routines (see Figure 4-3)
- Channel CH1 Gain switching routines (see Figure 4-4)
- Bit width changing routines (see Figure 4-5)
- UART Transmit Interrupt routine (see Figure 4-6)
- UART Receive Interrupt routine (see Figure 4-6)
- INT0 Interrupt routine (see Figure 4-6)

PIC18F87J72 Evaluation Board User's Guide

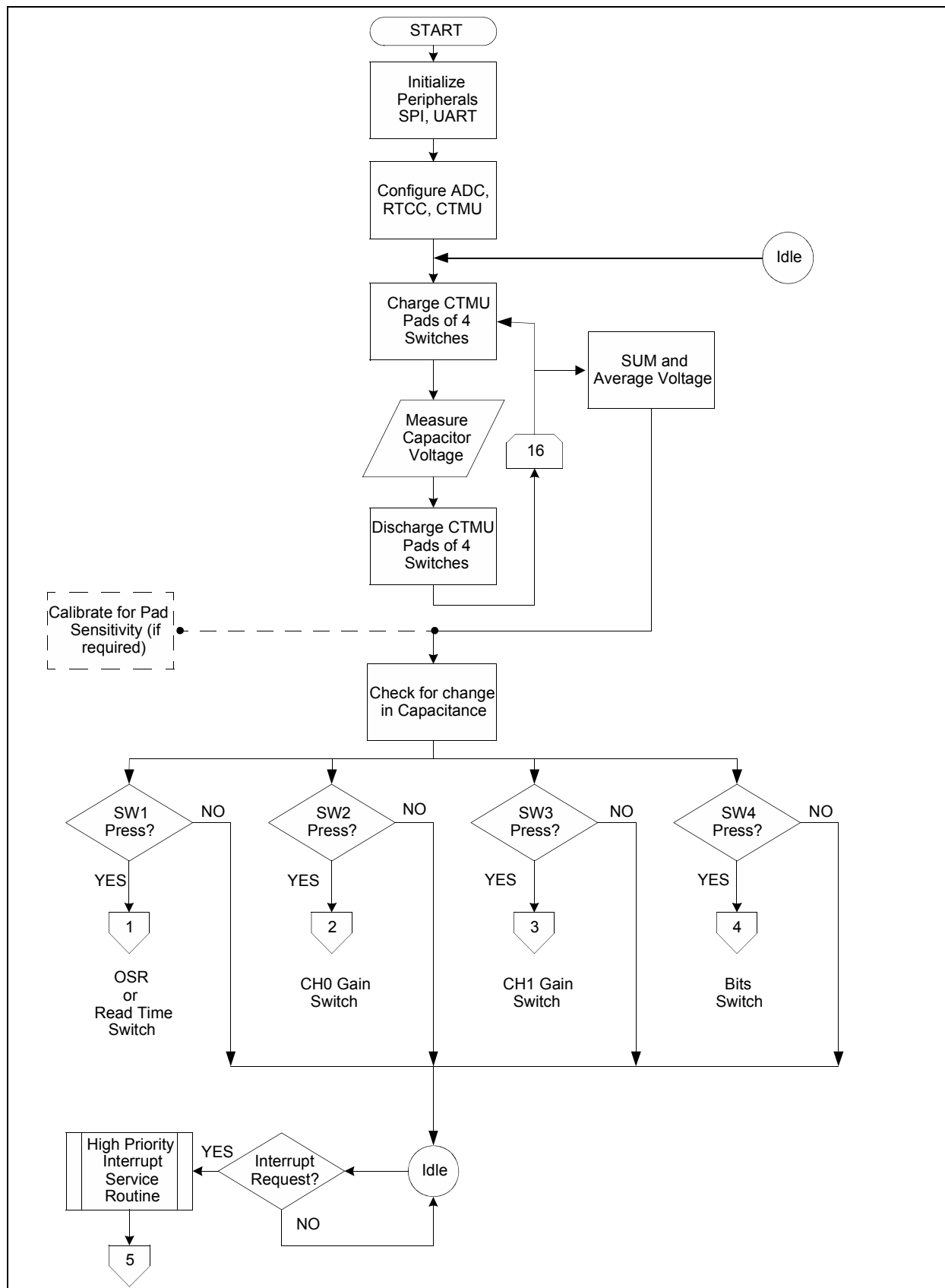

FIGURE 4-1: Main Routine

PIC18F87J72 Evaluation Board Firmware Flowchart

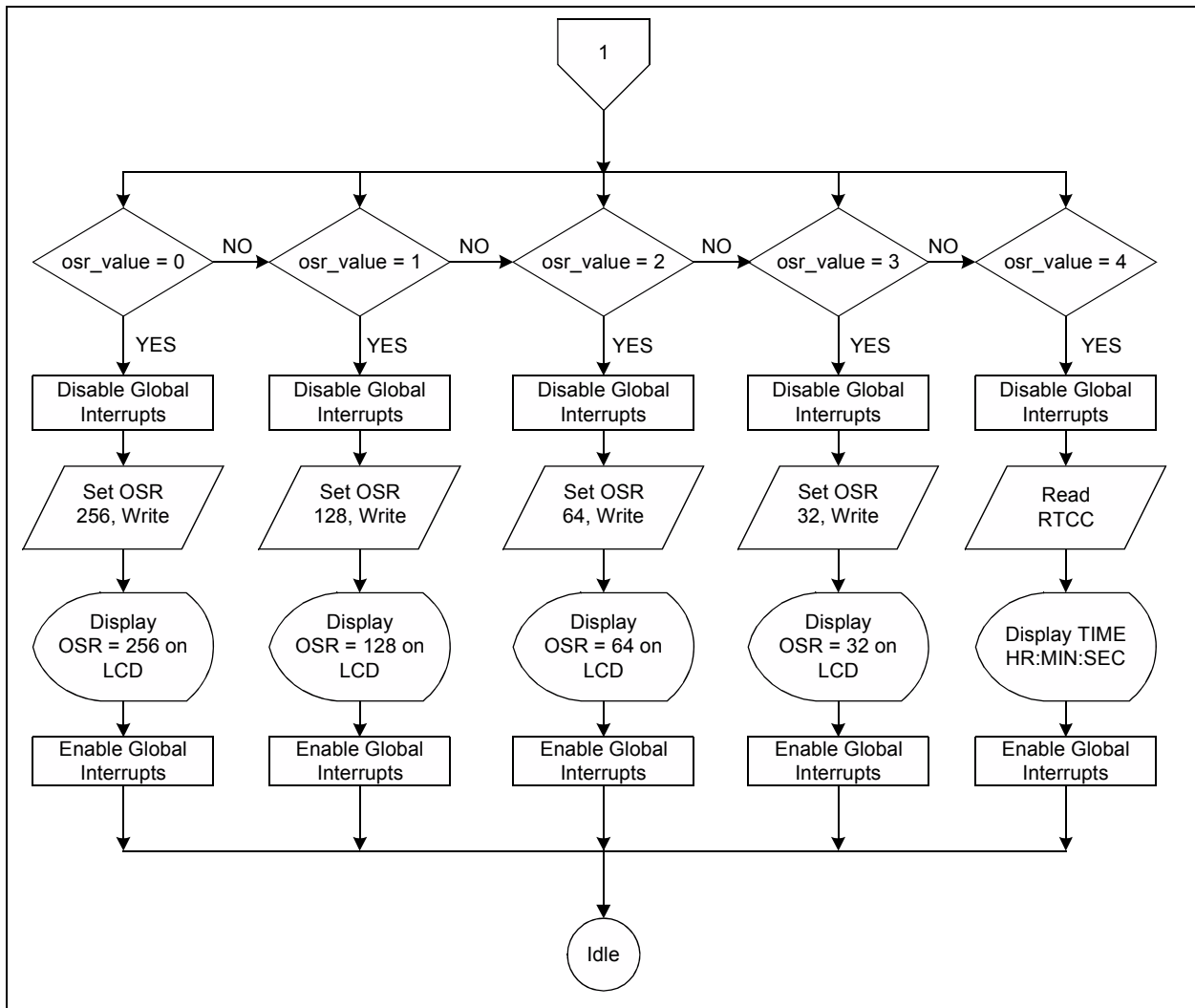

FIGURE 4-2: Key Press Routine to Configure OSR and Display Time.

PIC18F87J72 Evaluation Board User's Guide

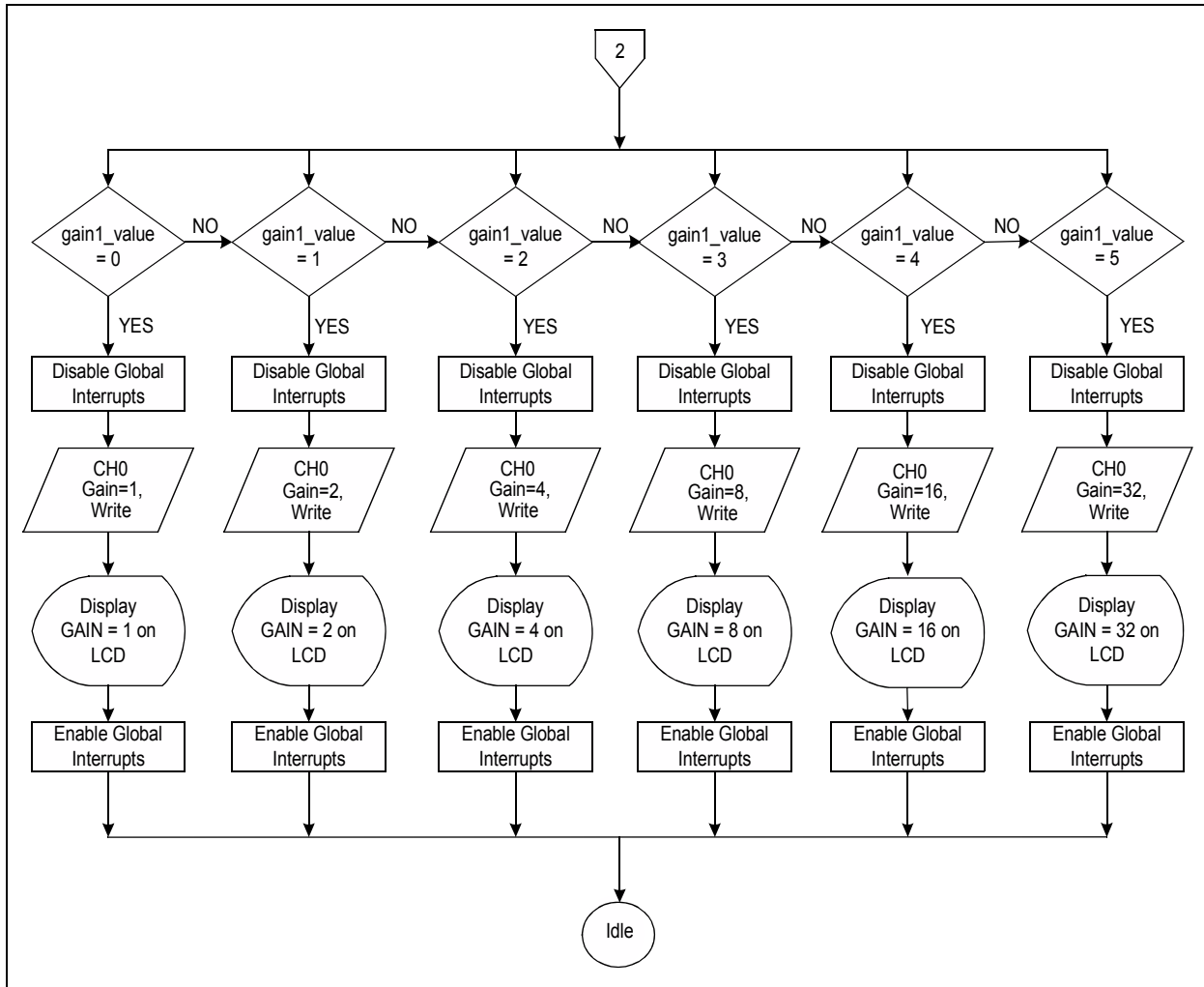

FIGURE 4-3: Key Press Routine to Configure Gain of Channel CH0.

PIC18F87J72 Evaluation Board Firmware Flowchart

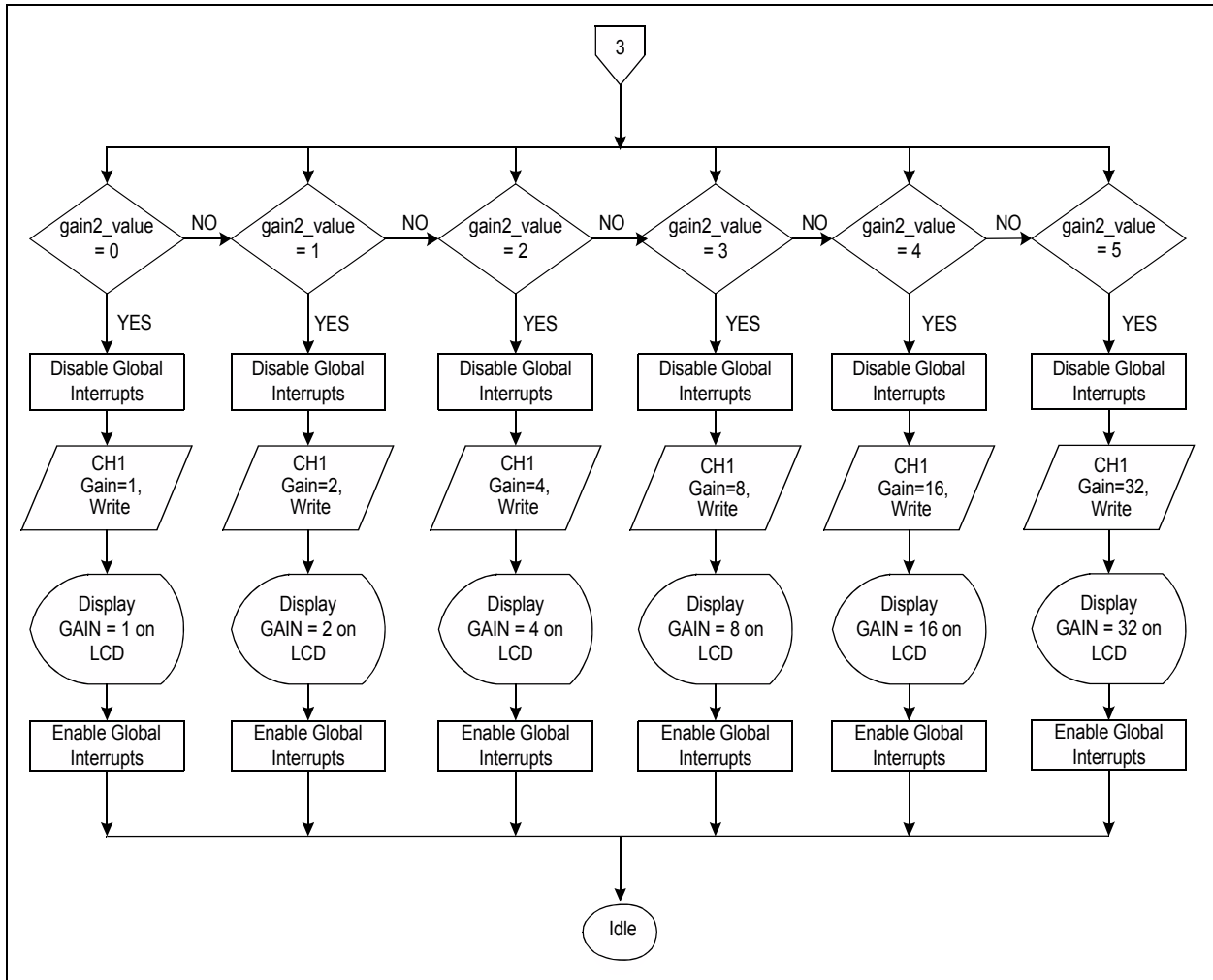

FIGURE 4-4: Key Press Routine to Configure Gain of Channel CH1.

PIC18F87J72 Evaluation Board User's Guide

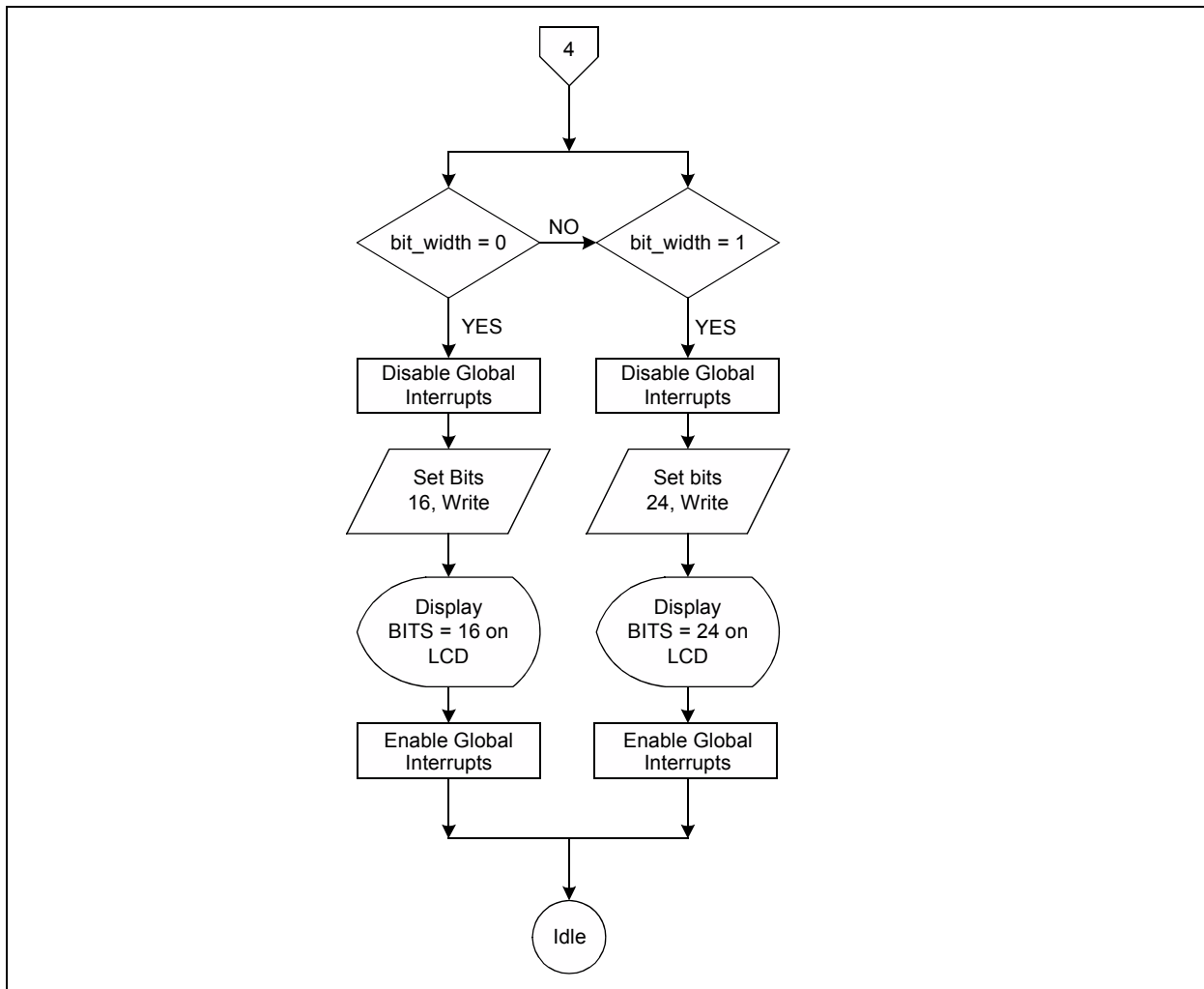

FIGURE 4-5: Key Press Routine to Configure Bit Width of Channel CH0 and CH1.

PIC18F87J72 Evaluation Board Firmware Flowchart

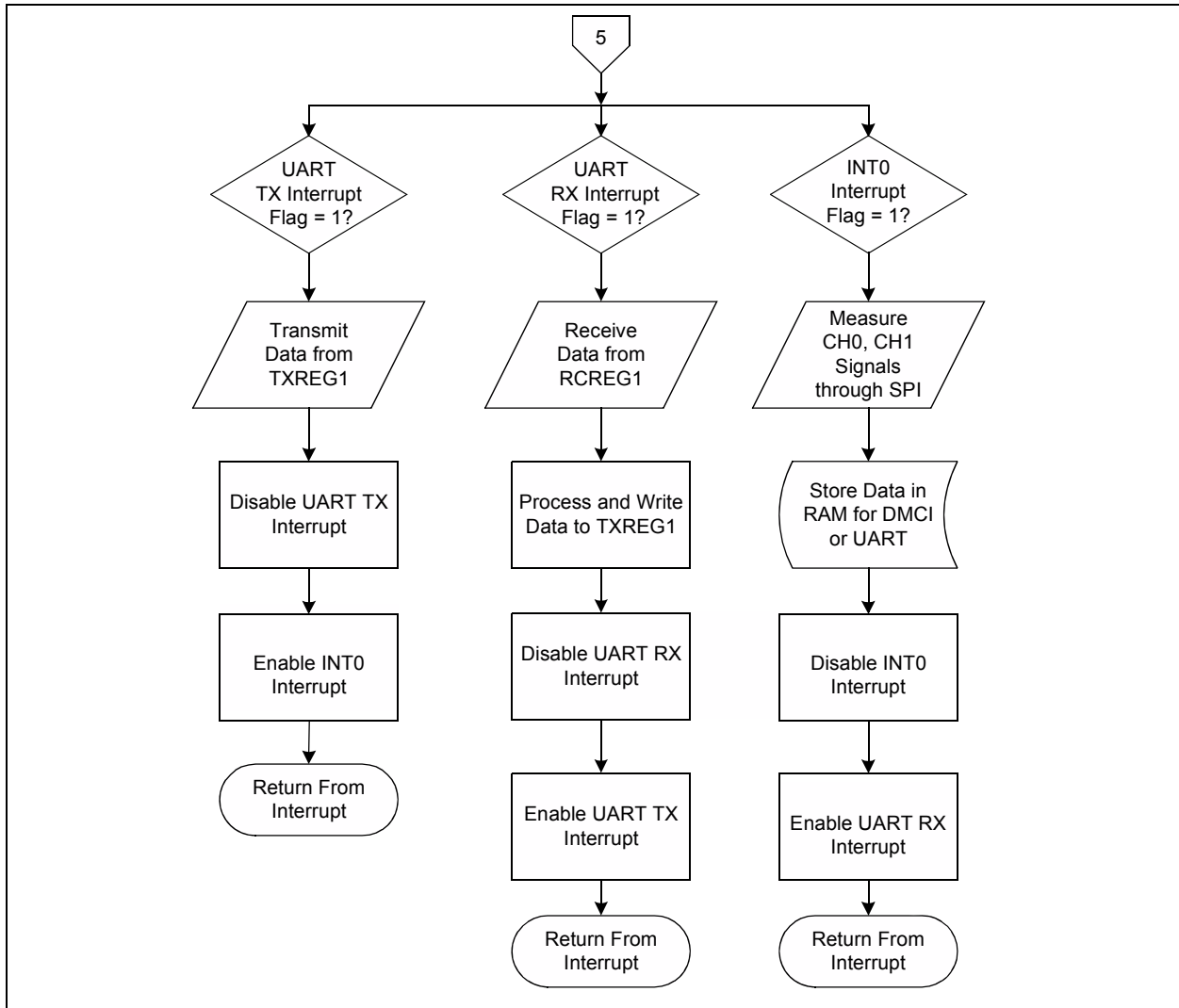

FIGURE 4-6: Interrupt Service Routine for UART and INT0 Interrupts.

PIC18F87J72 Evaluation Board User's Guide

NOTES:

Chapter 5. PIC18F87J72 Evaluation Board Lab Test Results

5.1 INTRODUCTION

This chapter provides the various laboratory test results obtained when using the PIC18F87J72 Evaluation Board. This chapter also describes the use of the Data Monitor and Control Interface (DMCI) window to plot the waveforms present on Channel CH0 and CH1 of the evaluation board. Displaying waveforms on the DMCI window can only be done when the user is working in Debugging mode. In Debugging mode, the MPLAB IDE needs to be uploaded and the debugger connected to the RJ11 connector of the PIC18F87J72 Evaluation Board.

Figure 5-1 shows two graphs (i.e., Graph 1 and Graph 2). Graph 1 shows the waveform created on Channel CH0 of the PIC18F87J72 Evaluation Board. Graph 2 shows the waveform created on Channel CH1 of the PIC18F87J72 Evaluation Board. CH0 and CH1 are both connected to the same signal of 300 mV. The internal PGA gain is chosen to be 8 for CH0 and 1 for Channel CH1.

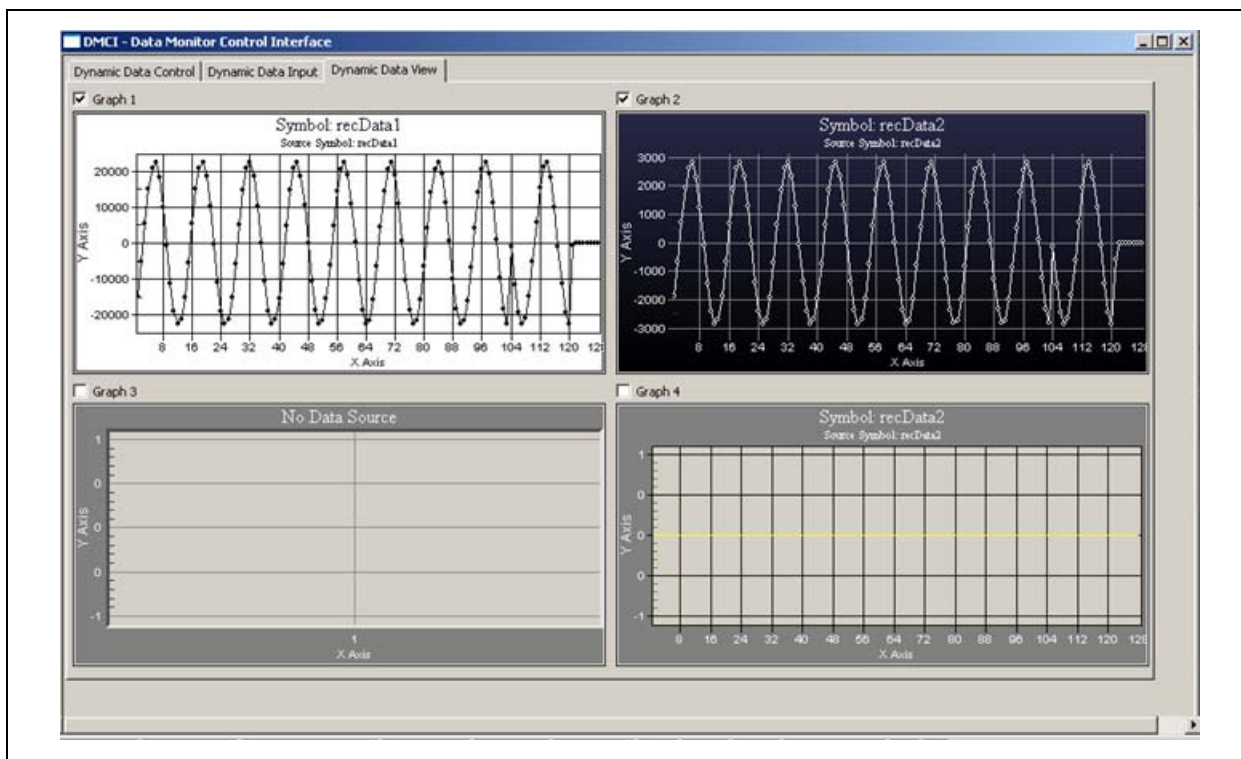

FIGURE 5-1: DMCI Waveforms for 300mV Waveform with CH0 Gain = 8, CH1 Gain = 1.

PIC18F87J72 Evaluation Board User's Guide

Figure 5-2 shows Graph 1 for CH0 and Graph 2 for CH1. The OSR for both CH0 and CH1 are chosen to be 32 and the signal amplitude applied at the input is a very low voltage sine wave signal of about 20 mV peak. The user can clearly observe the distortion of the waveform with such a low OSR value.

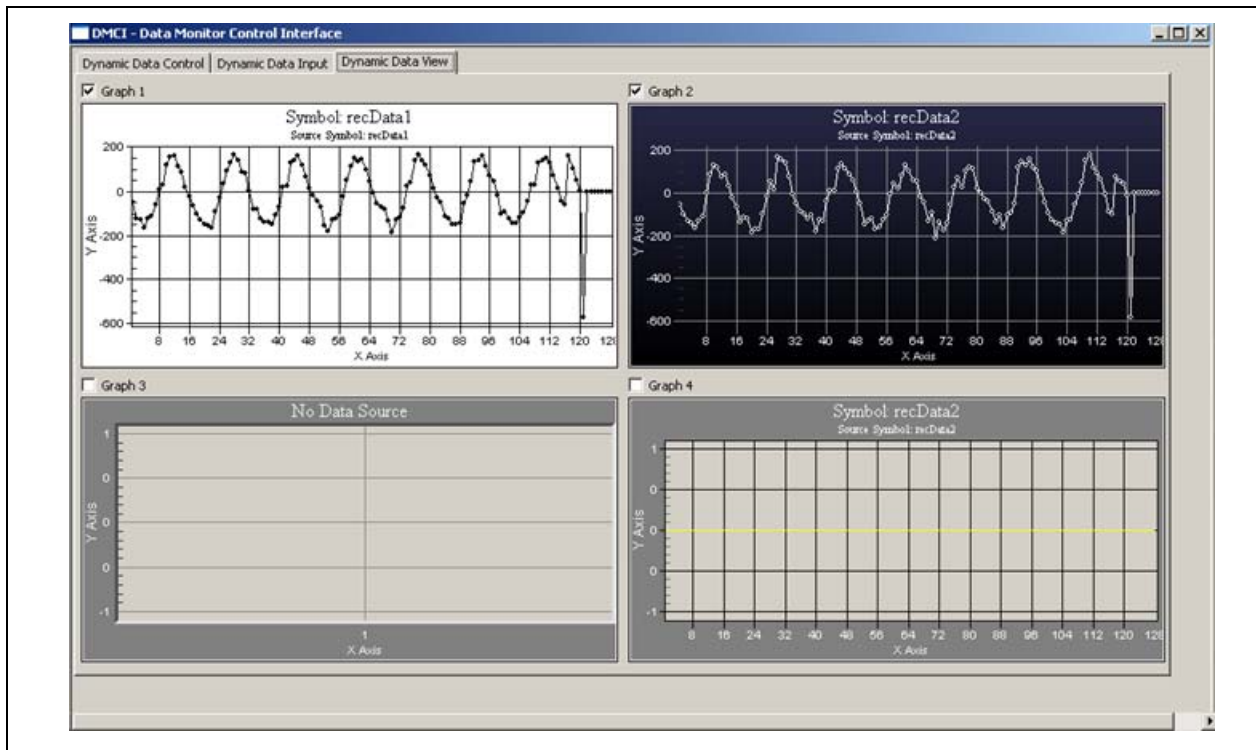

FIGURE 5-2: DMCI Waveforms for 20mV Waveform with OSR = 32 on CH0 and CH1.

PIC18F87J72 Evaluation Board Lab Test Results

Figure 5-3 shows Graph 1 for CH0 and Graph 2 for CH1. The OSR for both CH0 and CH1 are chosen to be 256 and the same signal is applied at the input with a very low voltage sine wave signal of about 20 mV peak. Here, the sine wave shape is still retained and the signal distortion is less when compared to Figure 5-2.

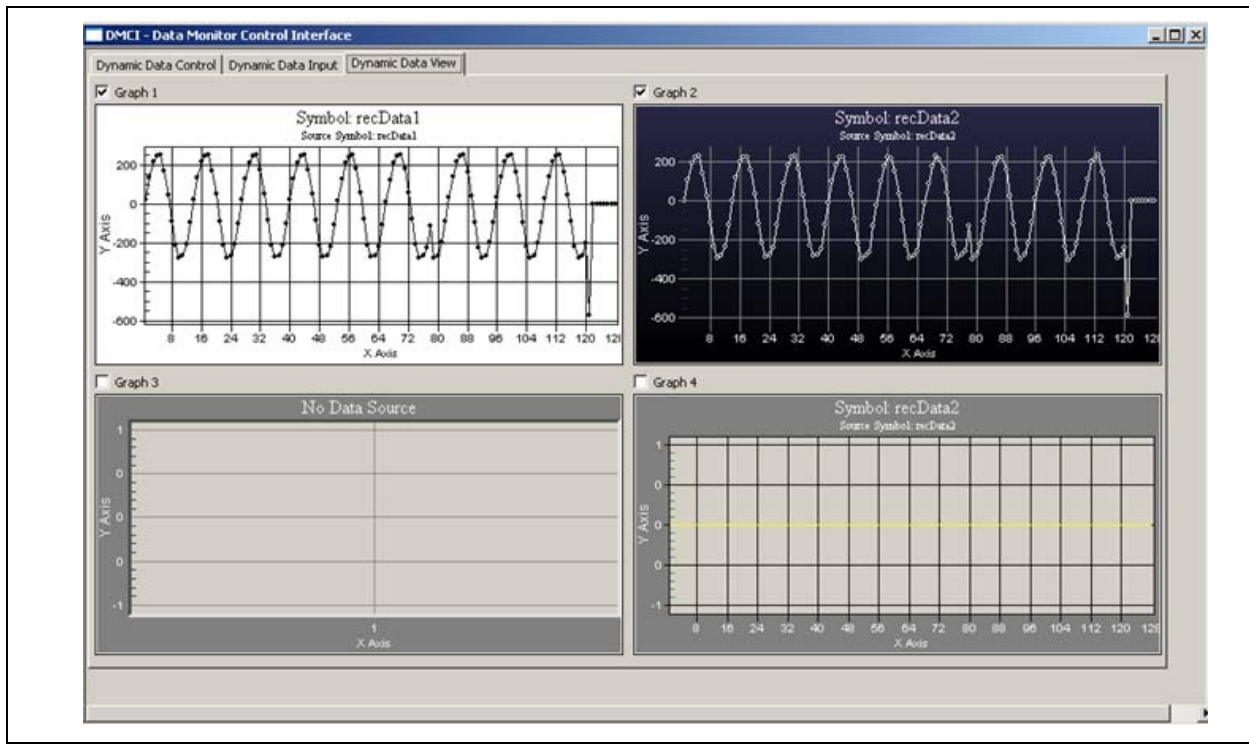

FIGURE 5-3: DMCI Waveforms for 20mV Waveform with OSR = 256 on CH0 and CH1.

PIC18F87J72 Evaluation Board User's Guide

Figure 5-4 shows Graph 1 for CH0 and Graph 2 for CH1. CH0 and CH1 are both connected to the same signal of 300 mV. The internal PGA gain is chosen to be 1 for CH0 and 32 for Channel CH1. The waveform on Graph 1 is intact, while the waveform on Graph 2 is saturated at a value of 32768. This demonstrates the effect of saturation when larger gains are used. This would distort the wave to a flat top waveform, and the information related to the shape of the signal would be lost.

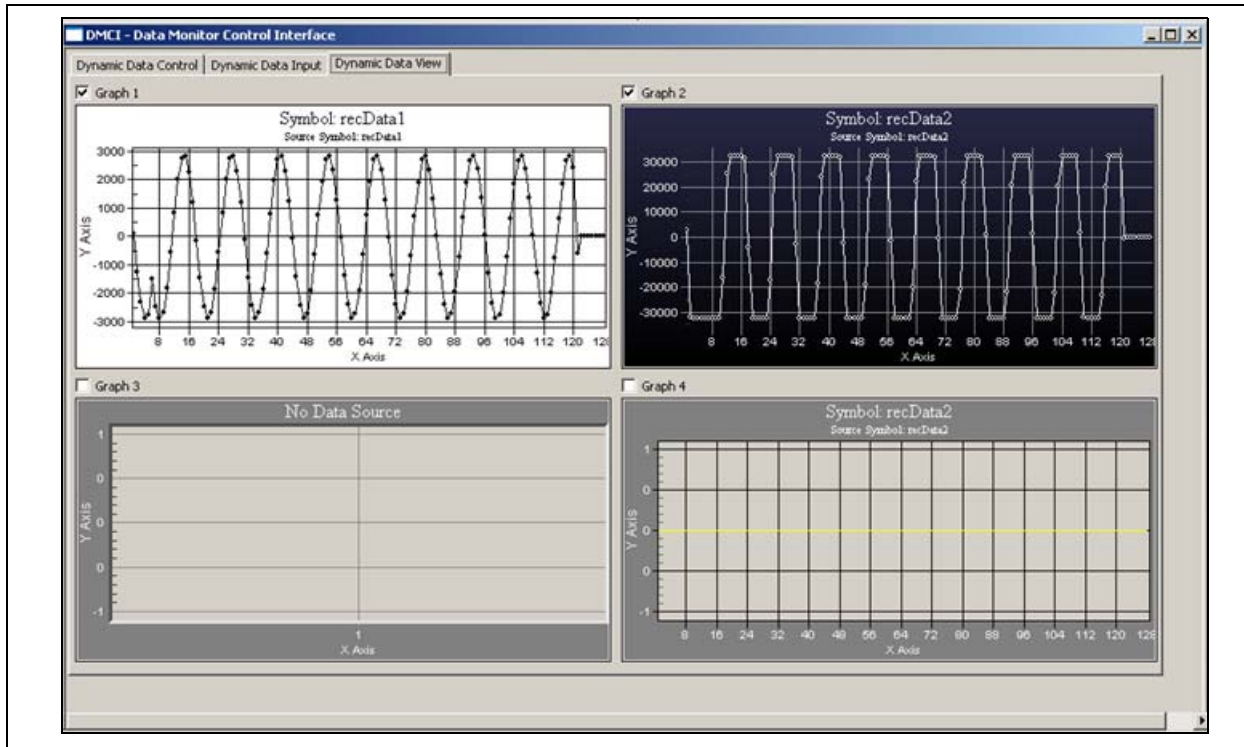

FIGURE 5-4: DMCI Waveforms for 300mV Waveform with CH0 Gain = 1, CH1 Gain = 32.

Chapter 6. PIC18F87J72 Evaluation Board GUI

6.1 INTRODUCTION

This chapter describes the Graphical User Interface used for the PIC18F87J72 Evaluation Board. Figure 6-1 indicates the various waveforms and the parameters that can be displayed on the GUI. The signals can be viewed in their real-time state in Time domain as well as in Frequency domain. UART is used for communication between the GUI and the microcontroller. The baud rate used for communication is 38400. To use the GUI, the following run-time engines must be installed:

- Visa441runtime
- LVRTE86std

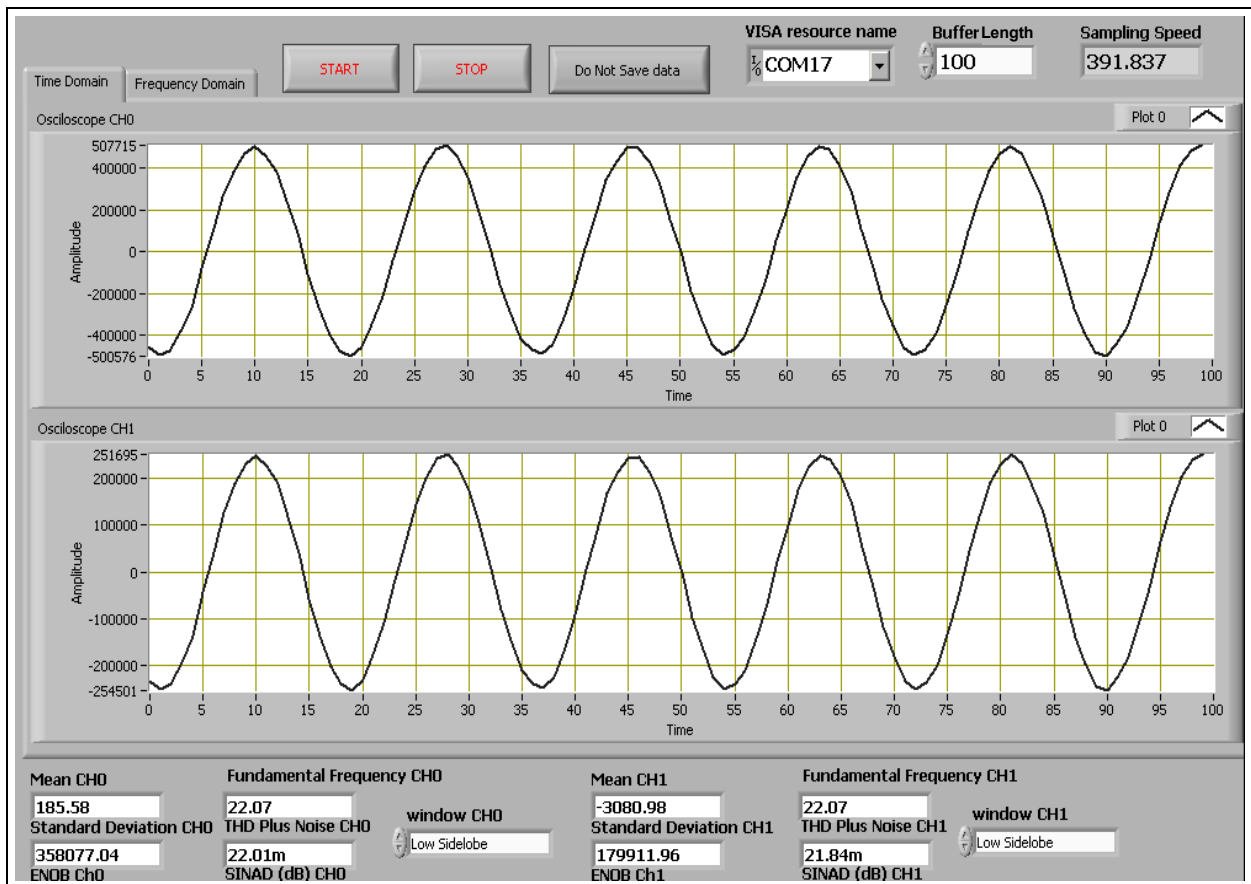

FIGURE 6-1: PIC18F87J72 Evaluation Board Graphical User Interface.

PIC18F87J72 Evaluation Board User's Guide

NOTES:



PIC18F87J72 EVALUATION BOARD USER'S GUIDE

Appendix A. Schematics and Layouts

A.1 INTRODUCTION

This appendix contains the following schematics and layouts of the PIC18F87J72 Evaluation Board:

- Board – Schematic 1
- Board – Schematic 2
- Board – Schematic 3
- Board – Schematic 4
- Board – PCB Front Page
- Board – PCB Top Silk
- Board – PCB Top Layer
- Board – PCB Bottom Layer
- Board – PCB Bottom Silk
- Board – PCB L1 Ground
- Board – PCB L2 VDD

PIC18F87J72 Evaluation Board User's Guide

A.2 BOARD – SCHEMATIC 1

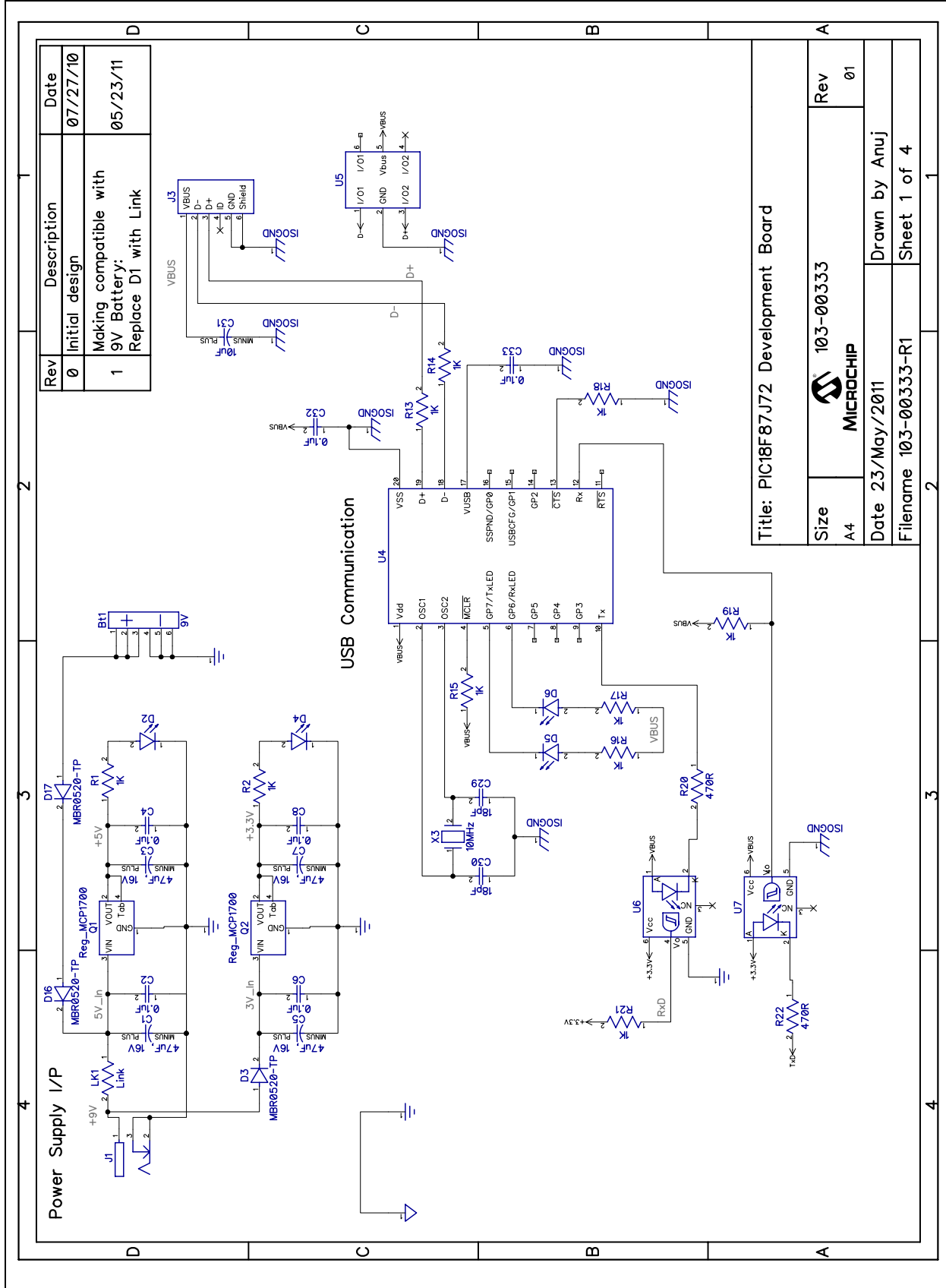

A.3 BOARD – SCHEMATIC 2

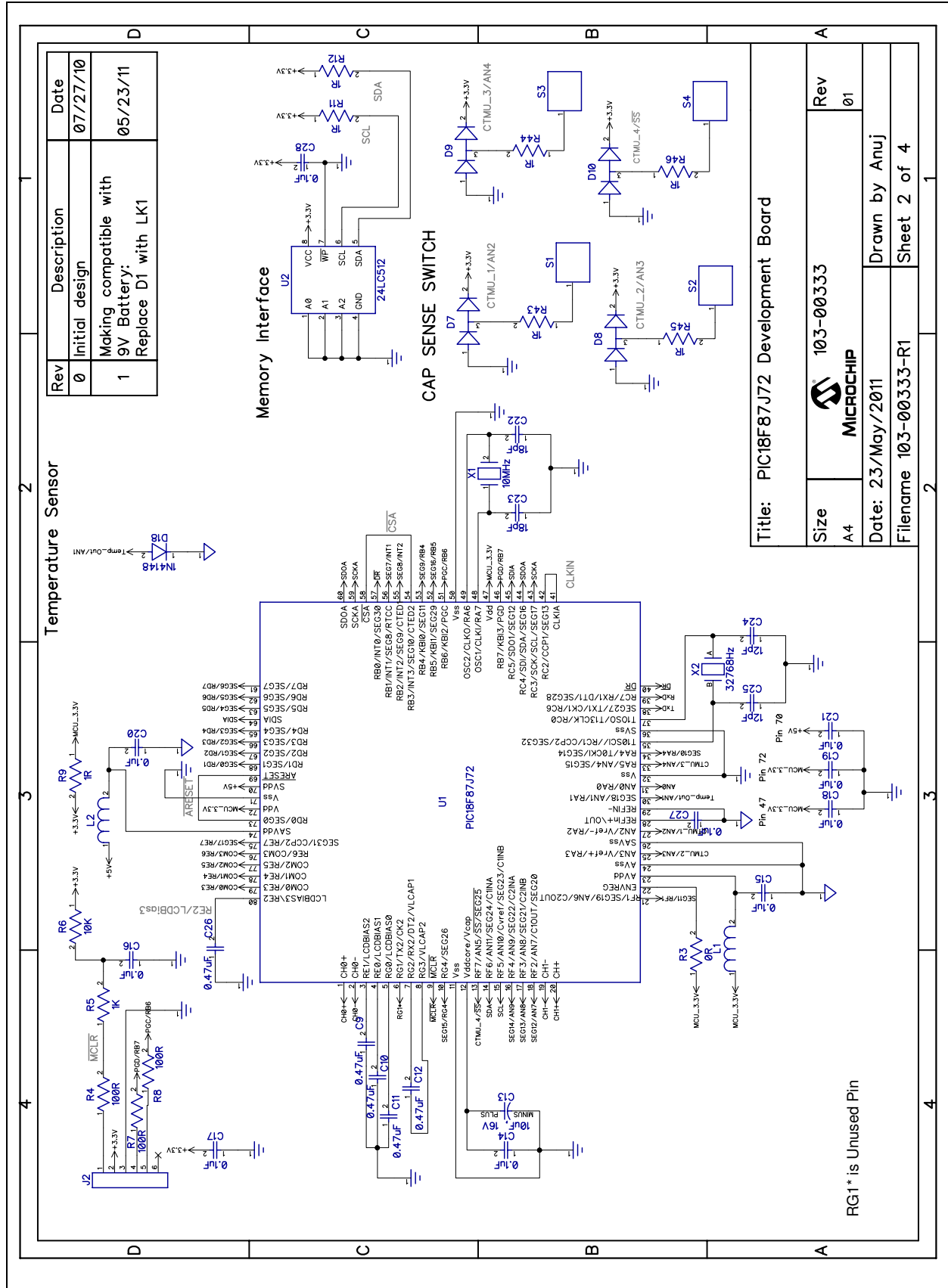

PIC18F87J72 Evaluation Board User's Guide

A.4 BOARD – SCHEMATIC 3

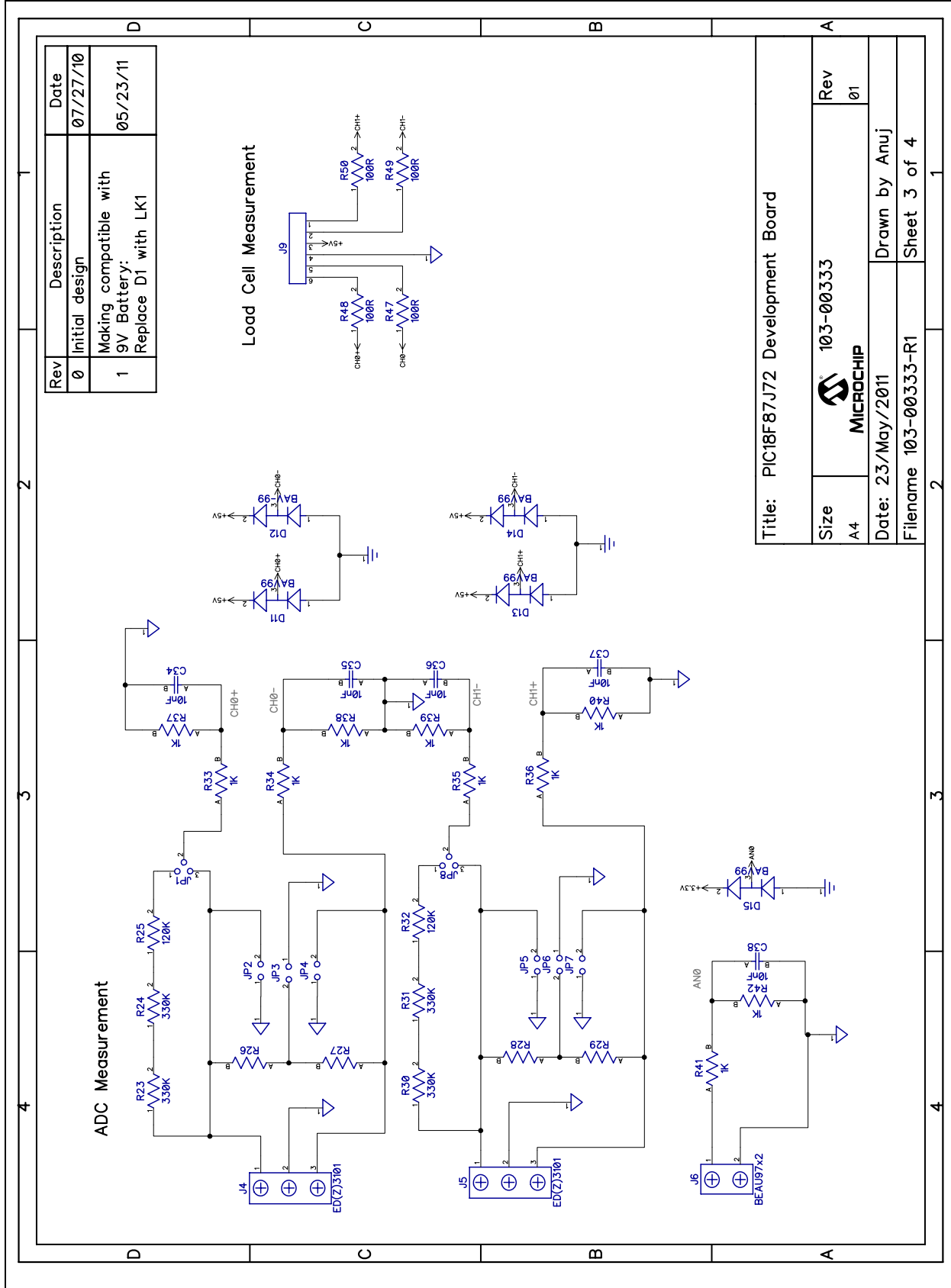

A.5 BOARD – SCHEMATIC 4

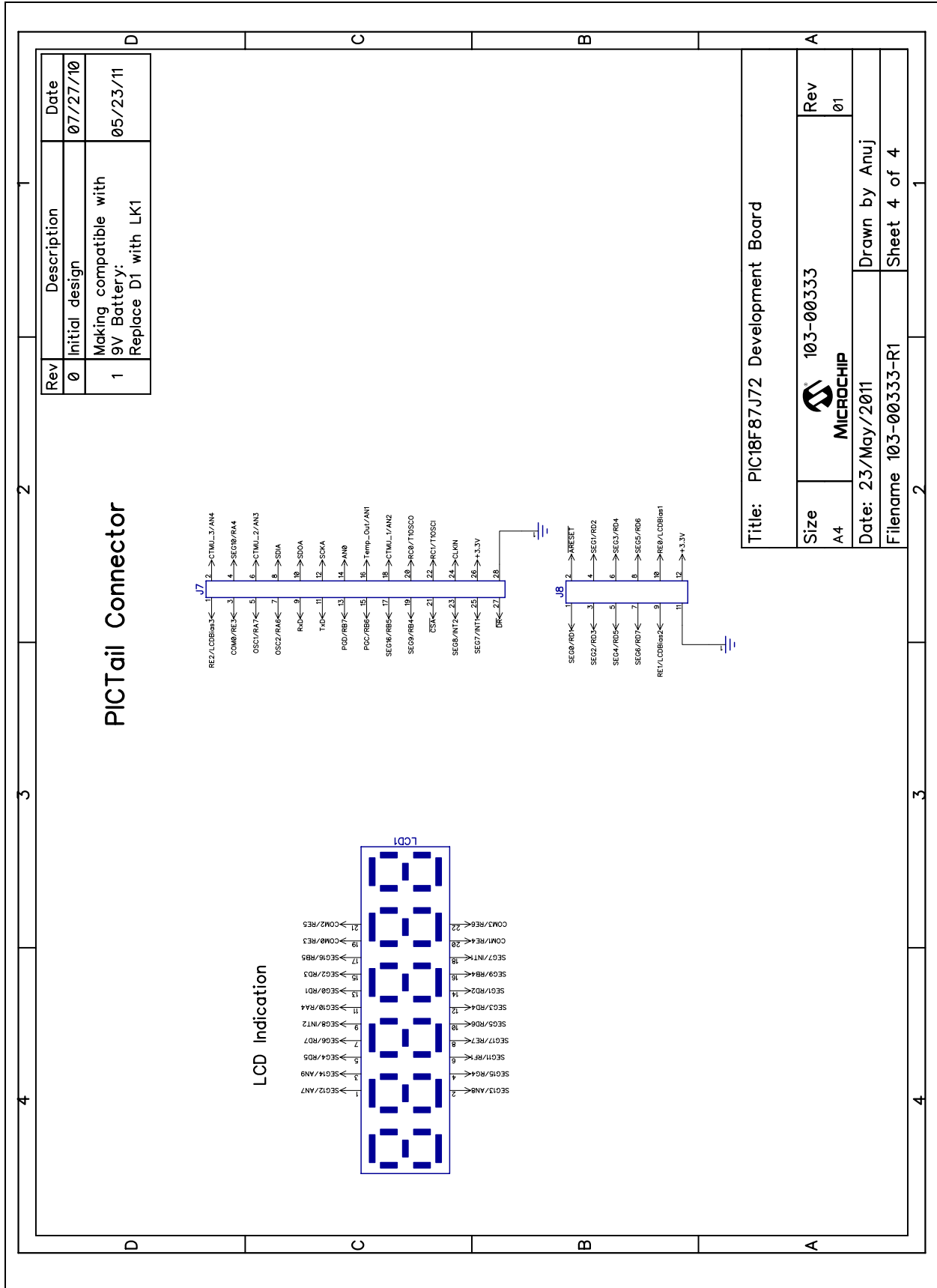

Rev	Description	Date
0	Initial design	07/27/10
1	Making compatible with 9V Battery: Replace D1 with LK1	05/23/11

Title: PIC18F87J72 Development Board

Size	103-00333	Rev	01
A4	MICROCHIP	Drawn by	Anuj
Date:	23/May/2011	Sheet	4 of 4
Filename	103-00333-R1		

PIC18F87J72 Evaluation Board User's Guide

A.6 BOARD – PCB FRONT PAGE

Rev	Description	Date
00	Initial Revision	08/25/10

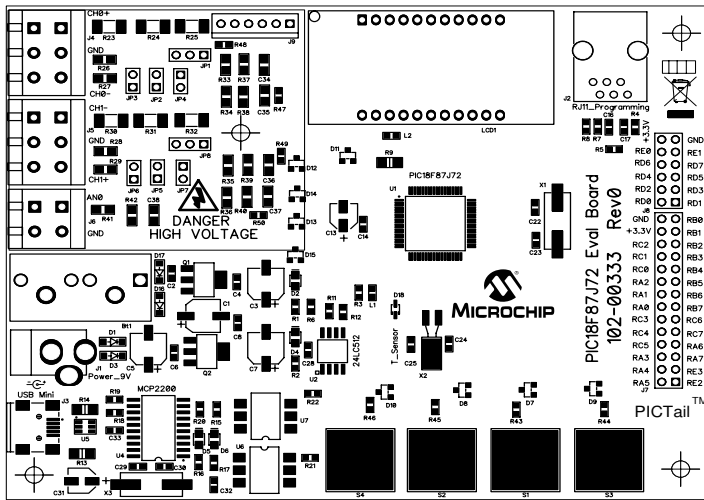

Title: PIC18F87J72 Eval Board		
Size 130x100	102-00333 MICROCHIP	Rev R 00
Date: 25/Aug/2010	Drawn by: Narasimh	
File Name:102-00333-R0.dip	Sheet: 1	

A.7 BOARD – PCB TOP SILK

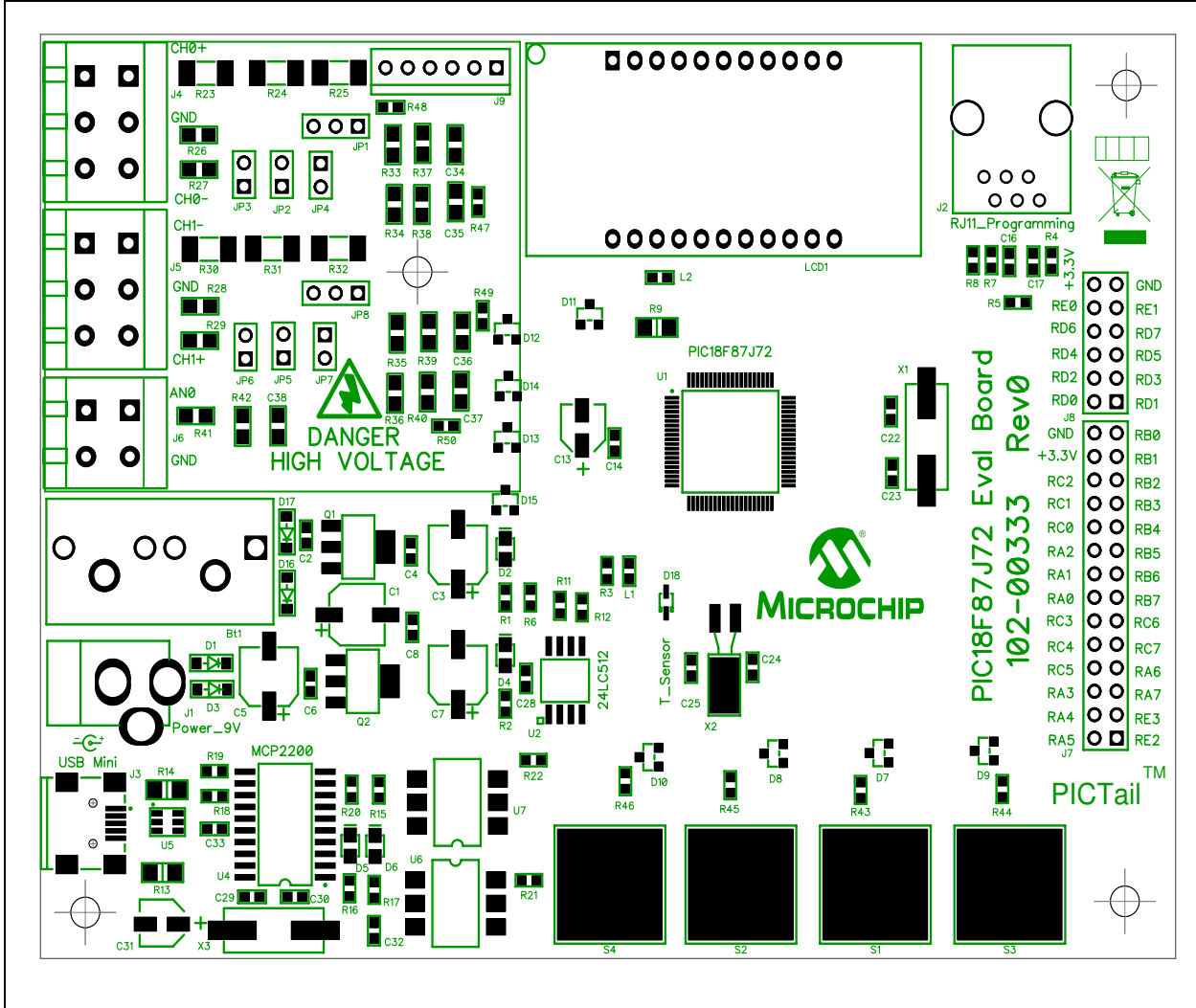

PIC18F87J72 Evaluation Board User's Guide

A.8 BOARD – PCB TOP LAYER

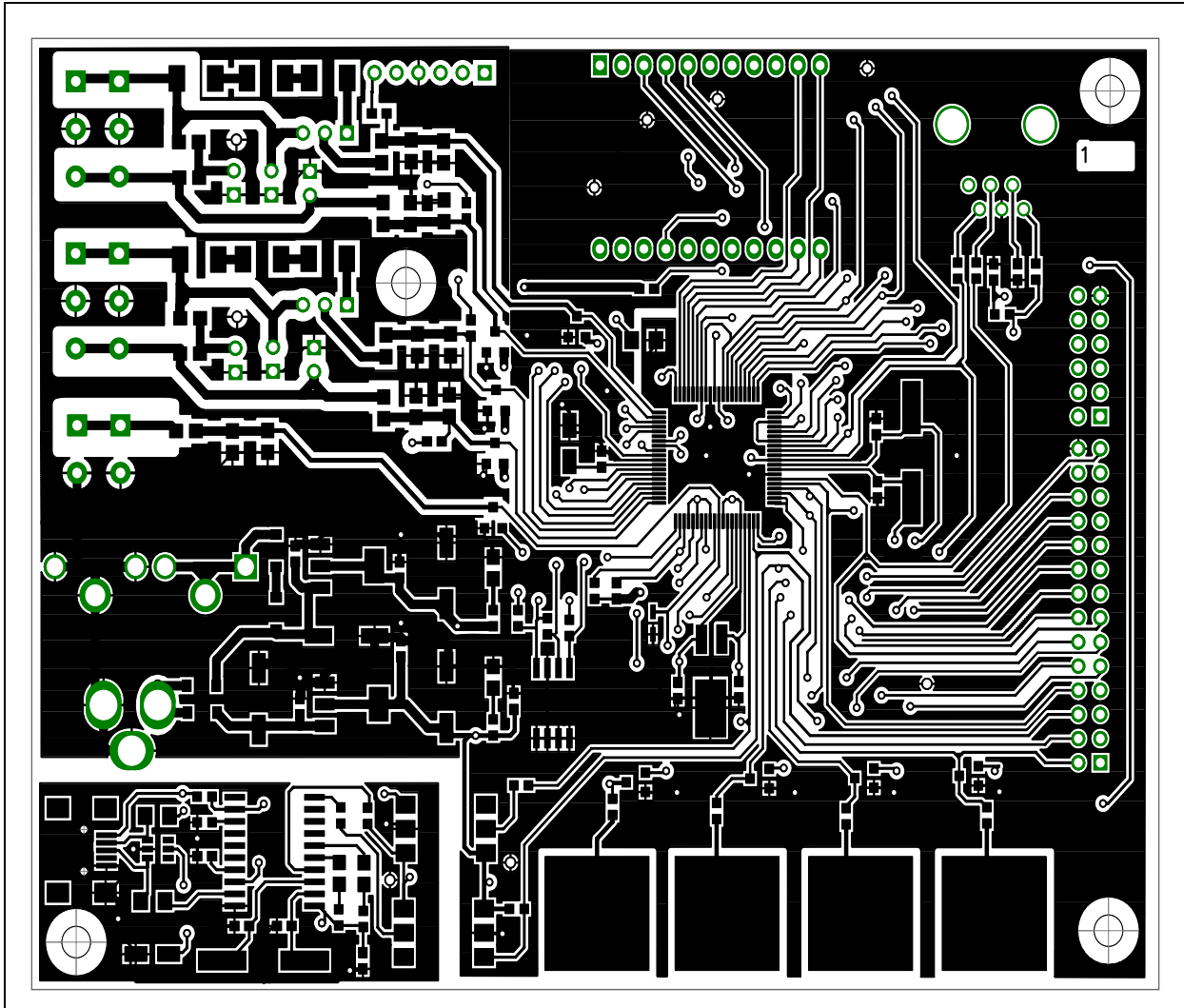

A.9 BOARD – PCB BOTTOM LAYER

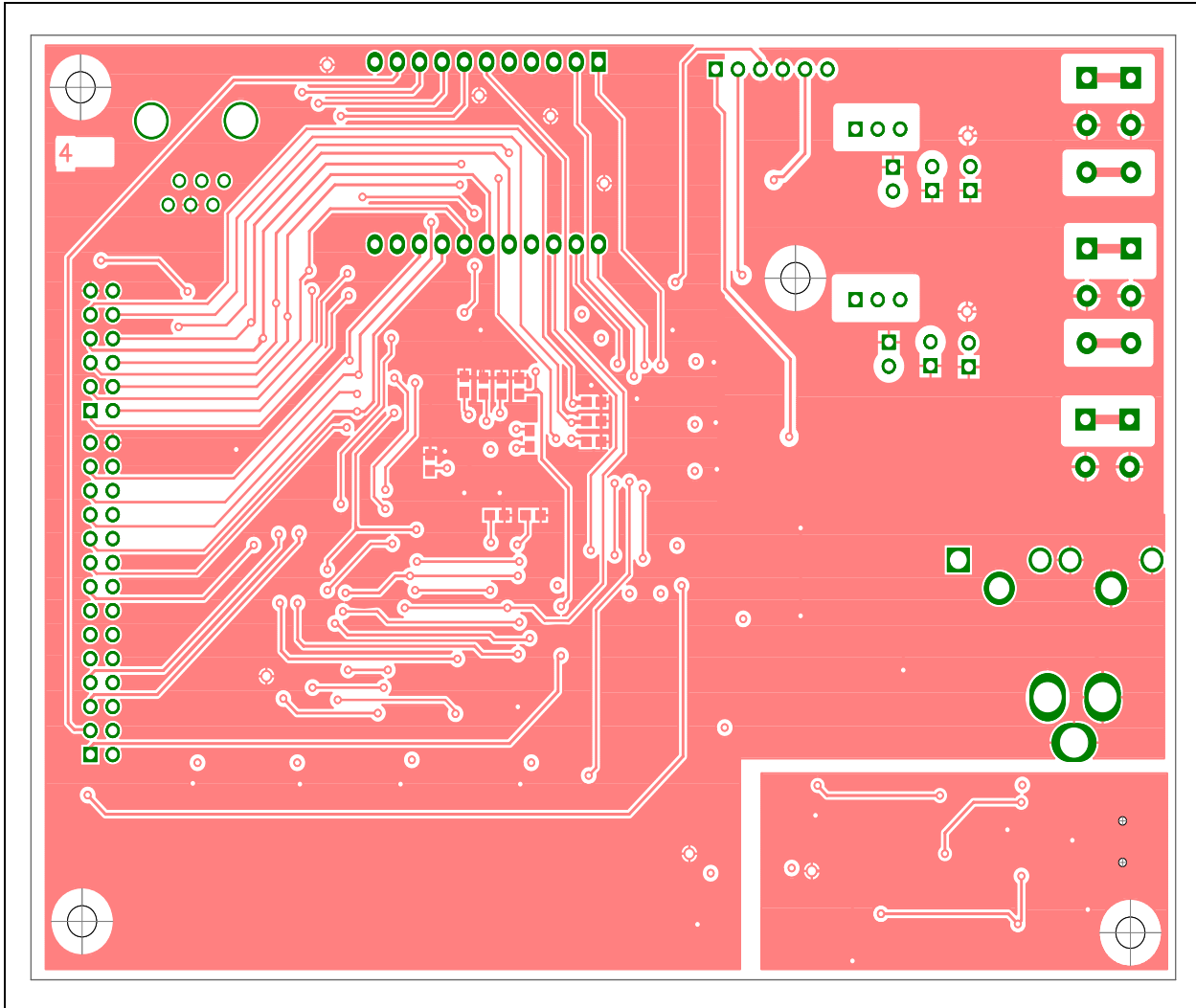

PIC18F87J72 Evaluation Board User's Guide

A.10 BOARD – PCB BOTTOM SILK

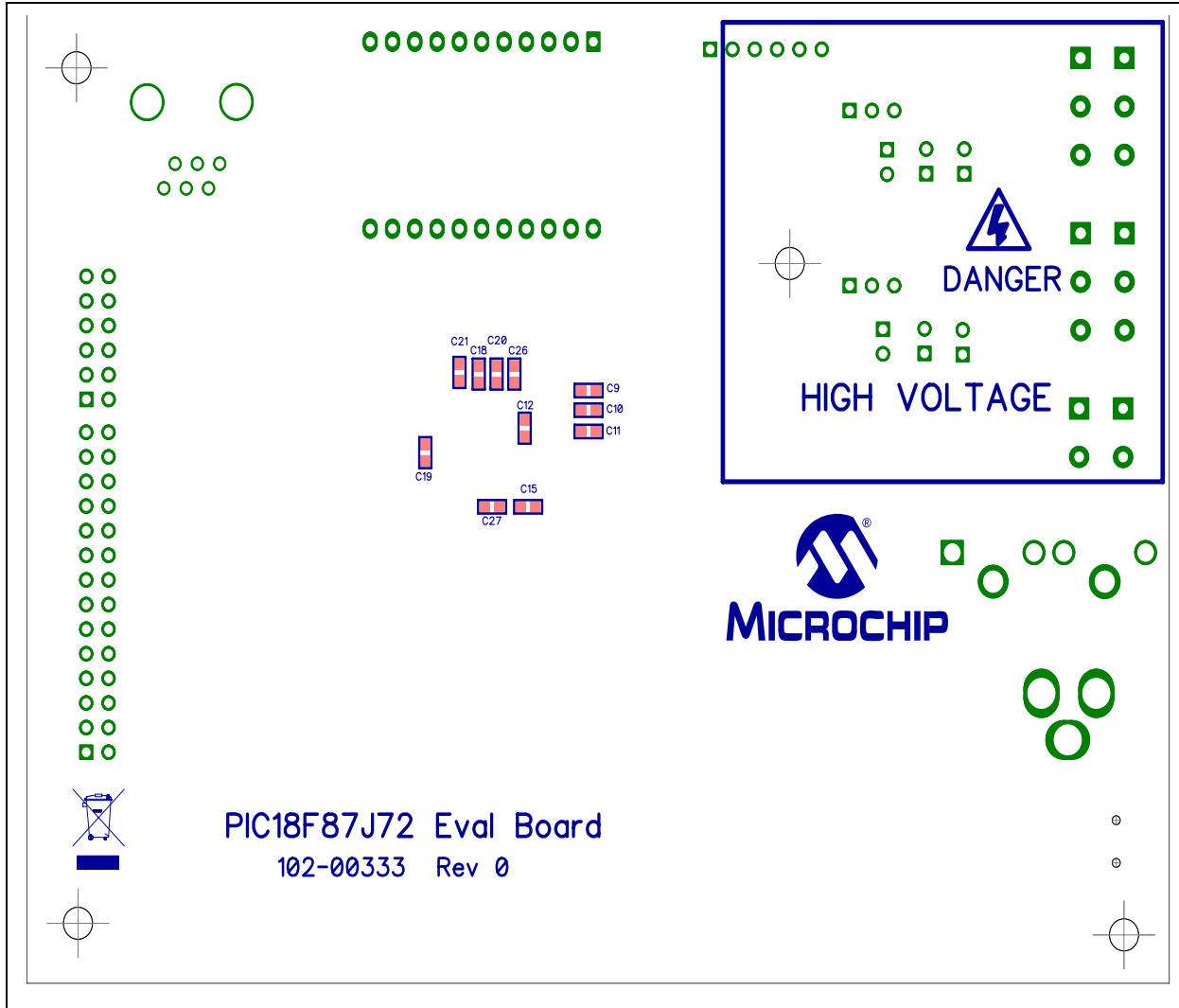

A.11 BOARD – PCB L1 GROUND

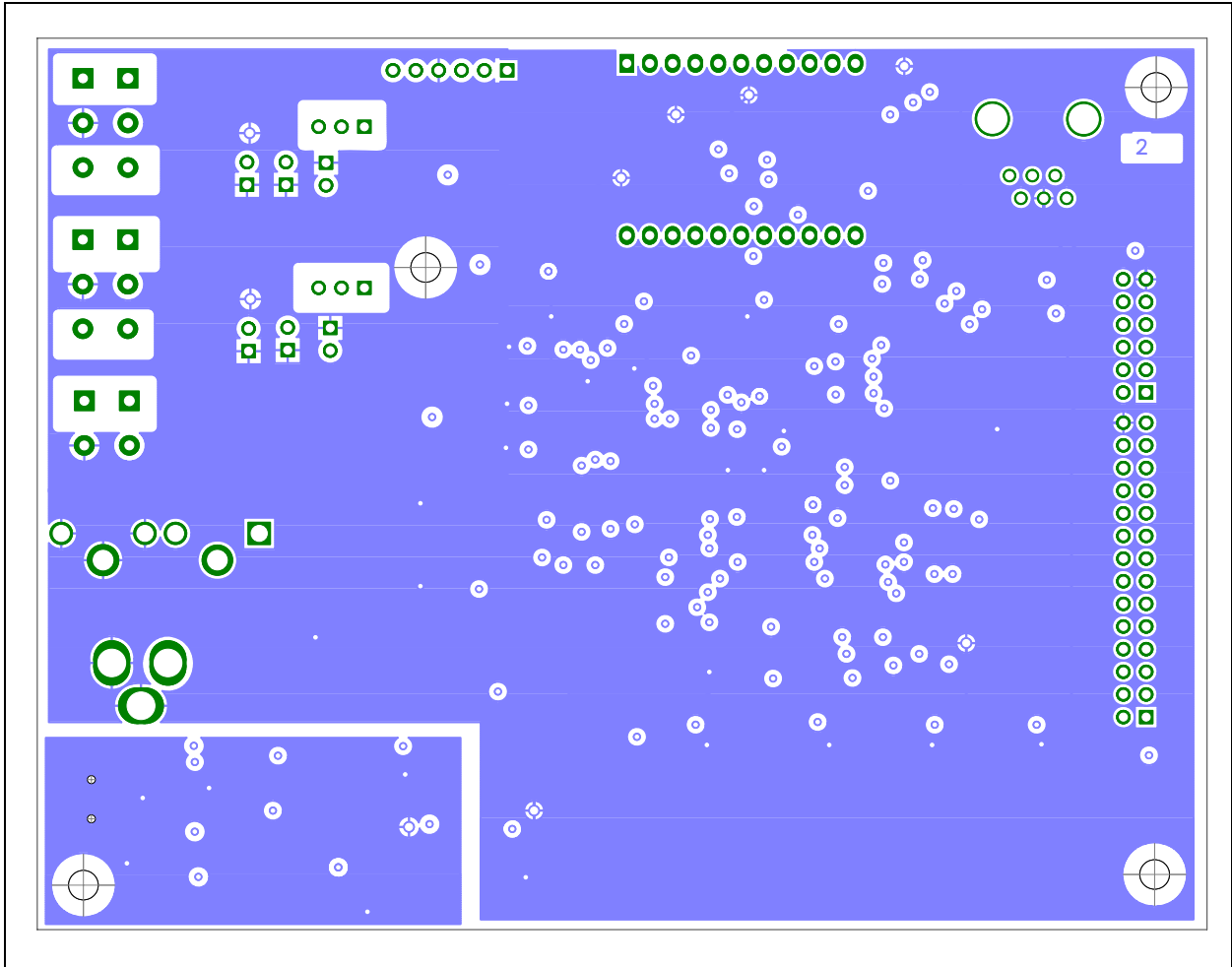

PIC18F87J72 Evaluation Board User's Guide

A.12 BOARD – PCB L2 V_{DD}

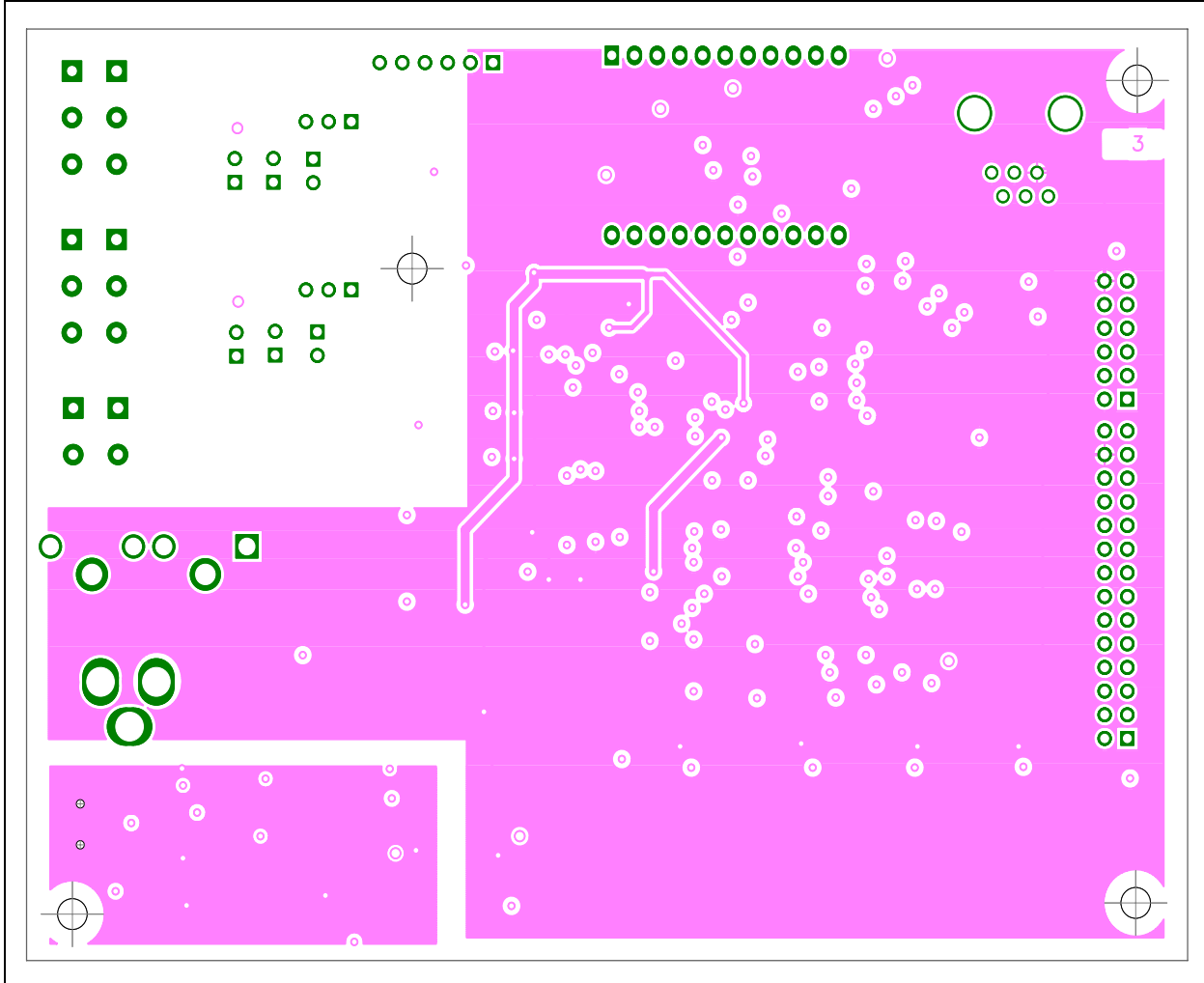

Appendix B. Bill of Materials (BOM)

This chapter provides the Bill of Materials for all the components and devices used on the PIC18F87J72 Evaluation Board.

TABLE B-1: BILL OF MATERIALS (BOM)

Qty	Reference	Description	Manufacturer	Part Number
1	BAT1	BATTERY IND ALKALINE 9 VOLT	Energizer	EN22
1	BAT1	CONN PC VERT 9V SNAP-ON	Keystone	96B
4	C1, C3, C5, C7	CAP 47UF 16V ELECT FP SMD	Panasonic® ECG	EEE-FPC470UAR
16	C2, C4, C6, C8, C14, C15, C16, C17, C18, C19, C20, C21, C27, C28, C32, C33	CAP CER .1UF 25V Y5V 0603	Murata Electronics®	GRM188F51E104ZAA01D
5	C9, C10, C11, C12, C26	CAP CER 47000PF 50V X7R 10% 0603	TDK Corporation	C1608X7R1H473K
2	C13, C31	CAP 10UF 16V ELECT FP SMD	Panasonic ECG	EEE-FP1C100AR
4	C22, C23, C29, C30	CAP CER 18PF 50V C0G 5% 0603	TDK Corporation	C1608C0G1H180J
2	C24, C25	CAP CER 12PF 50V C0G 5% 0603	TDK Corporation	C1608C0G1H120J
5	C34, C35, C36, C37, C38	CAP CER 10000PF 50V 10% X7R 0805	Murata Electronics	GRM216R71H103KA01D
4	D1, D3, D16, D17	DIODE SCHOTTKY 20V 500MA SOD123	Micro Commercial Components	MBR0520-TP
2	D2, D4	LED GREEN CLEAR 0805 SMD	Lite-On Semi.	LTST-C170GKT
2	D5, D6	LED YELLOW CLEAR 0805 SMD	Lite-On Semi.	LTST-C170YKT
9	D7, D8, D9, D10, D11, D12, D13, D14, D15	DIODE SWITCH 215MA 70V SOT-23	Comchip Tech.	BAV99-G
1	D18	DIODE 75V 150MA SOD323F	Fairchild Semi.	1N4148WS
1	J1	CONN POWERJACK MINI R/A T/H	Switchcraft	RAPC722X
1	J2	CONN 6-6 MOD JACK	Stewart Connector	SS-7066-NF
1	J3	CONN USB RCPT MINI B 5PS R/A SMD	JAE Electronics	DX2R005HN2E700
2	J4, J5	TERMINAL BLOCK 5MM 3POS PCB	On-Shore Tech.	ED3101/3-WD
1	J6	TERMINAL BLOCK 5MM 2POS PCB	On-Shore Tech.	ED3101/2-WD
1	J7	CONN RECEIPT 28POS .100 VERT DUAL	TE Connectivity	1-234998-4
1	J8	CONN RECEIPT 12POS .100 VERT DUAL	3M	960230-6202-AR
1	J9	CONN HEADER 6POS .100" STR TIN	Molex	90120-0126

Bill of Materials (BOM)

TABLE B-1: BILL OF MATERIALS (BOM) (CONTINUED)

Qty	Reference	Description	Manufacturer	Part Number
2	JP1, JP8	CONN HEADER 3POS .100" STR TIN	Molex	90120-0123
6	JP2, JP3, JP4, JP5, JP6, JP7	CONN HEADER 2POS .100 VERT TIN	Molex/Waldom Electronics Corp.	22-03-2021
2	L1, L2	FERRITE CHIP 120 OHM 2000MA 0603	Murata Electronics	BLM18PG121SN1D
1	LCD1	Energy Meter LCD Display	Deepkashi Display Devices	DP-093
1	PCB	RoHS Compliant Bare PCB, PIC18F87J72 Evaluation Board		104-00333
1	Q1	IC REG LDO 800MA 5.0V SOT-223	National Semi.	LM1117MPX-5.0/NOPB
1	Q2	IC REG LDO 800MA 3.3V SOT-223	National Semi.	LM1117MPX-3.3/NOPB
11	R1, R2, R5, R11, R12, R15, R16, R17, R18, R19, R21	RES 1K OHM 1/10W 5% 0603 SMD	Stackpole Elec.	RMCF 1/16 1K 5% R
1	R3	RES 0.0 OHM 1/10W 0603 SMD	Stackpole Elec.	RMCF 1/16 0 R
7	R4, R7, R8, R47, R48, R49, R50	RES 100 OHM 1/10W 5% 0603 SMD	Stackpole Elec.	RMCF 1/16 100 5% R
1	R6	RES 10K OHM 1/10W 5% 0603 SMD	Stackpole Elec.	RMCF 1/16 10K 5% R
1	R9	RES 1.0 OHM 1/4W 5% 1206 SMD	ROHM Semi.	MCR18EZPJ1R0
2	R13, R14	RES 47.0 OHM 1/4W 1% 1206 SMD	ROHM Semi.	MCR18EZPF47R0
2	R20, R22	RES 470 OHM 1/10W 5% 0603 SMD	Stackpole Elec.	RMCF 1/16 470 5% R
4	R23, R24, R30, R31	RES 330K OHM 1/2W 5% 2010 SMD	ROHM Semi.	MCR50JZHJ334
2	R25, R32	RES 120K OHM 1/2W 5% 2010 SMD	ROHM Semi.	MCR50JZHJ124
4	R26, R27, R28, R29	RES 47 OHM 1/8W .1% 0805 SMD	Panasonic ECG	ERA-6AEB470V
10	R33, R34, R35, R36, R37, R38, R39, R40, R41, R42	RES 1.0K OHM 1/8W .1% 0805 SMD	SUSUMU Co.	RG2012P-102-B-T
4	R43, R44, R45, R46	RESISTOR 1.0 OHM 1/10W 5% 0603	Panasonic ECG	ERJ-3GEY1R0V
1	U1	80-Pin, High-Performance Microcontrollers with Dual-Channel AFE, LCD Driver and nanoWatt Technology TQFP-80	Microchip Tech. Inc.	PIC18F87J72-I/PT
1	U2	512K I2C Serial EEPROM SOIC-8	Microchip Tech. Inc.	24LC512-I/SM
2	U3, U6	OPTOCOUPLER LOGIC OUT VDE 6-SMD	Fairchild Semi.	H11L1SR2VM
1	U4	USB 2.0 to UART protocol Converter with GPIO SSOP-20	Microchip Technology Inc.	MCP2200-I/SO
1	U5	IC ESD PROTECTION LO CAP SOT23-6	STMicroelectronics	USBLC6-2SC6
1	X1	CRYSTAL 10.000MHZ 18PF SMD	ECS Ltd.	ECS-100-18-5PX-TR
1	X2	CRYSTAL 32.768 KHZ 12.5PF CYL	ECS Ltd.	ECS-327-12.5-13X
1	X3	CRYSTAL 12.000MHZ 18PF SMD	ECS Ltd.	ECS-120-18-5PX-TR

NOTES:



MICROCHIP

Worldwide Sales and Service

AMERICAS

Corporate Office
2355 West Chandler Blvd.
Chandler, AZ 85224-6199
Tel: 480-792-7200
Fax: 480-792-7277
Technical Support:
<http://www.microchip.com/support>
Web Address:
www.microchip.com

Atlanta
Duluth, GA
Tel: 678-957-9614
Fax: 678-957-1455

Boston
Westborough, MA
Tel: 774-760-0087
Fax: 774-760-0088

Chicago
Itasca, IL
Tel: 630-285-0071
Fax: 630-285-0075

Cleveland
Independence, OH
Tel: 216-447-0464
Fax: 216-447-0643

Dallas
Addison, TX
Tel: 972-818-7423
Fax: 972-818-2924

Detroit
Farmington Hills, MI
Tel: 248-538-2250
Fax: 248-538-2260

Indianapolis
Noblesville, IN
Tel: 317-773-8323
Fax: 317-773-5453

Los Angeles
Mission Viejo, CA
Tel: 949-462-9523
Fax: 949-462-9608

Santa Clara
Santa Clara, CA
Tel: 408-961-6444
Fax: 408-961-6445

Toronto
Mississauga, Ontario,
Canada
Tel: 905-673-0699
Fax: 905-673-6509

ASIA/PACIFIC

Asia Pacific Office
Suites 3707-14, 37th Floor
Tower 6, The Gateway
Harbour City, Kowloon
Hong Kong
Tel: 852-2401-1200
Fax: 852-2401-3431

Australia - Sydney
Tel: 61-2-9868-6733
Fax: 61-2-9868-6755

China - Beijing
Tel: 86-10-8569-7000
Fax: 86-10-8528-2104

China - Chengdu
Tel: 86-28-8665-5511
Fax: 86-28-8665-7889

China - Chongqing
Tel: 86-23-8980-9588
Fax: 86-23-8980-9500

China - Hangzhou
Tel: 86-571-2819-3180
Fax: 86-571-2819-3189

China - Hong Kong SAR
Tel: 852-2401-1200
Fax: 852-2401-3431

China - Nanjing
Tel: 86-25-8473-2460
Fax: 86-25-8473-2470

China - Qingdao
Tel: 86-532-8502-7355
Fax: 86-532-8502-7205

China - Shanghai
Tel: 86-21-5407-5533
Fax: 86-21-5407-5066

China - Shenyang
Tel: 86-24-2334-2829
Fax: 86-24-2334-2393

China - Shenzhen
Tel: 86-755-8203-2660
Fax: 86-755-8203-1760

China - Wuhan
Tel: 86-27-5980-5300
Fax: 86-27-5980-5118

China - Xian
Tel: 86-29-8833-7252
Fax: 86-29-8833-7256

China - Xiamen
Tel: 86-592-2388138
Fax: 86-592-2388130

China - Zhuhai
Tel: 86-756-3210040
Fax: 86-756-3210049

ASIA/PACIFIC

India - Bangalore
Tel: 91-80-3090-4444
Fax: 91-80-3090-4123

India - New Delhi
Tel: 91-11-4160-8631
Fax: 91-11-4160-8632

India - Pune
Tel: 91-20-2566-1512
Fax: 91-20-2566-1513

Japan - Yokohama
Tel: 81-45-471- 6166
Fax: 81-45-471-6122

Korea - Daegu
Tel: 82-53-744-4301
Fax: 82-53-744-4302

Korea - Seoul
Tel: 82-2-554-7200
Fax: 82-2-558-5932 or
82-2-558-5934

Malaysia - Kuala Lumpur
Tel: 60-3-6201-9857
Fax: 60-3-6201-9859

Malaysia - Penang
Tel: 60-4-227-8870
Fax: 60-4-227-4068

Philippines - Manila
Tel: 63-2-634-9065
Fax: 63-2-634-9069

Singapore
Tel: 65-6334-8870
Fax: 65-6334-8850

Taiwan - Hsin Chu
Tel: 886-3-6578-300
Fax: 886-3-6578-370

Taiwan - Kaohsiung
Tel: 886-7-213-7830
Fax: 886-7-330-9305

Taiwan - Taipei
Tel: 886-2-2500-6610
Fax: 886-2-2508-0102

Thailand - Bangkok
Tel: 66-2-694-1351
Fax: 66-2-694-1350

EUROPE

Austria - Wels
Tel: 43-7242-2244-39
Fax: 43-7242-2244-393

Denmark - Copenhagen
Tel: 45-4450-2828
Fax: 45-4485-2829

France - Paris
Tel: 33-1-69-53-63-20
Fax: 33-1-69-30-90-79

Germany - Munich
Tel: 49-89-627-144-0
Fax: 49-89-627-144-44

Italy - Milan
Tel: 39-0331-742611
Fax: 39-0331-466781

Netherlands - Drunen
Tel: 31-416-690399
Fax: 31-416-690340

Spain - Madrid
Tel: 34-91-708-08-90
Fax: 34-91-708-08-91

UK - Wokingham
Tel: 44-118-921-5869
Fax: 44-118-921-5820

05/02/11