

MATERIAL NUMBER	ALTERNATE NUMBER	"S"	WIRE RANGE	COLOR	PACKAGING
190570026	A-532-04	.119/3.02	22-18 AWG	RED	LOOSE PIECE
190570028	A-526-06	.146/3.70	22-18 AWG	RED	
190570030	A-526-08	.173/4.39	22-18 AWG	RED	
190570027	A-526-04T	.119/3.02	22-18 AWG	RED	TAPE
190570029	A-526-06T	.146/3.70	22-18 AWG	RED	
190570031	A-526-08T	.173/4.39	22-18 AWG	RED	

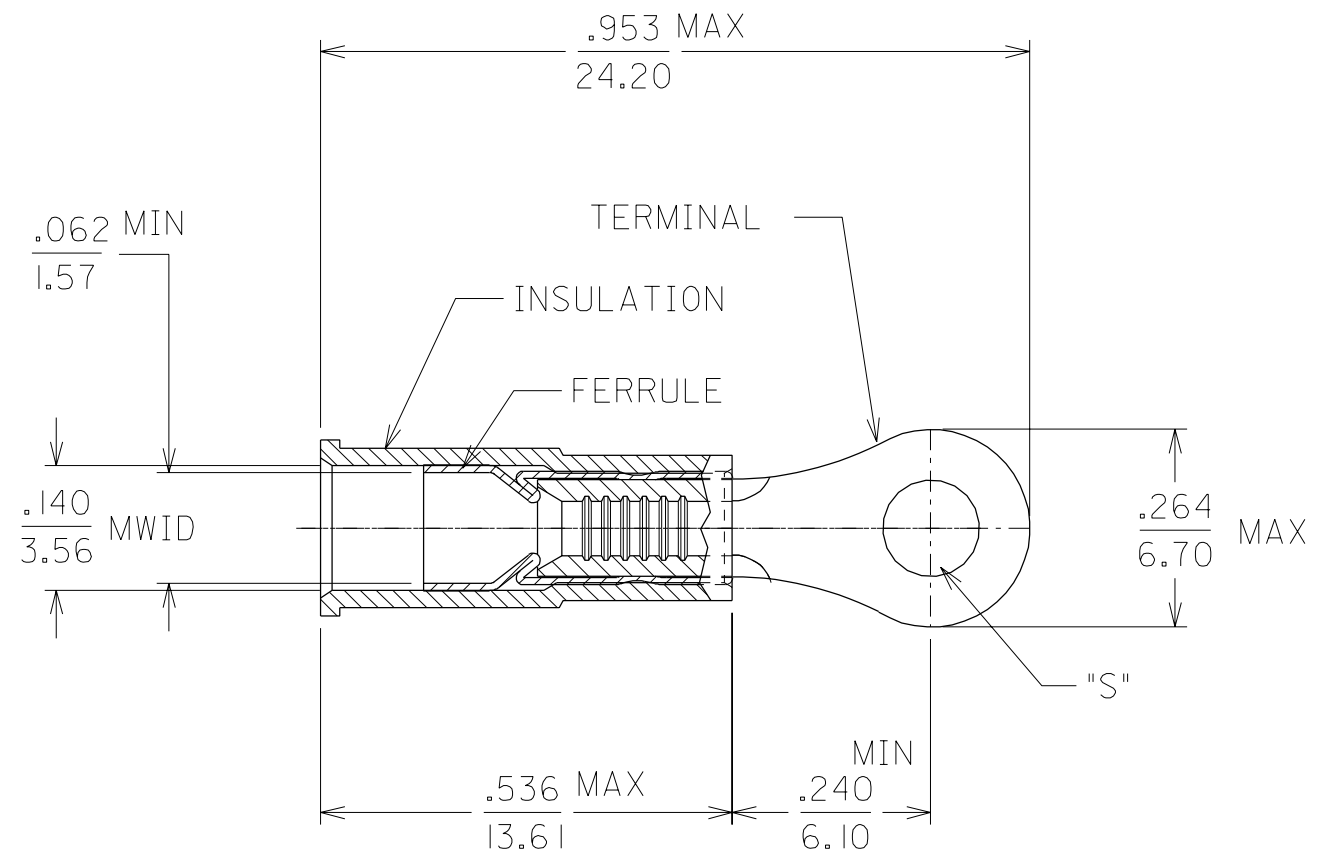
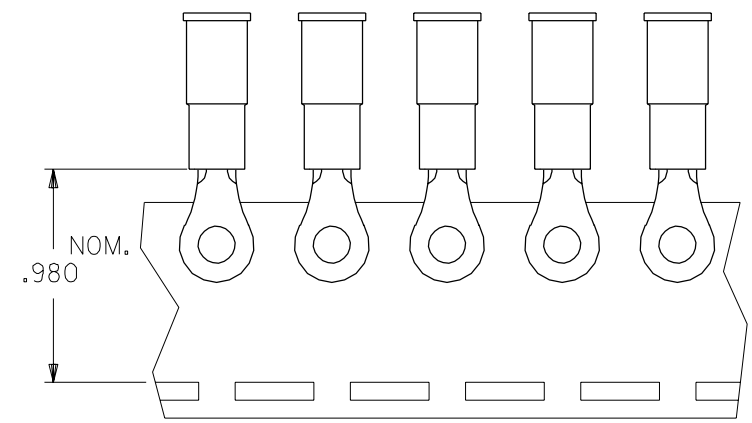

A	NEW CUST. DWG. ETC2001-0288 01/03/23 EDB
LTR.	REVISIONS

CUSTOMER DRAWING

- MATERIAL: TERMINAL: COPPER
.028/.711 THICK.
FUNNEL FERRULE: BRASS
PLATING: ELECTRO TIN
INSULATION: NYLON 6/6
COLOR: SEE CHART
- MWID = MAXIMUM WIRE INSULATION DIAMETER
- ALL DIMENSIONS = INCHES / MM

DIMENSIONS SHOWN (METRIC) INCH		REVISE ONLY ON CAD SYSTEM																			
UNLESS OTHERWISE SPECIFIED TOLERANCES: ANGULAR ± 1/2°		TITLE RING TONGUE TERMINAL AVIKRIMP 500 SERIES																			
<table border="1"> <thead> <tr> <th></th> <th>INCH</th> <th>METRIC</th> </tr> </thead> <tbody> <tr> <td>3 PLACE</td> <td>± .005</td> <td>± ---</td> </tr> <tr> <td>2 PLACE</td> <td>± .01</td> <td>± 0.13</td> </tr> <tr> <td>1 PLACE</td> <td>± ---</td> <td>± 0.25</td> </tr> </tbody> </table>			INCH	METRIC	3 PLACE	± .005	± ---	2 PLACE	± .01	± 0.13	1 PLACE	± ---	± 0.25	<table border="1"> <tr> <td>molex ETC INC.</td> <td>SHEET NO.</td> <td>DATE</td> </tr> <tr> <td>PINELLAS PARK, FLA. 33781 U.S.A.</td> <td>1 OF 1</td> <td>01/03/23</td> </tr> </table>		molex ETC INC.	SHEET NO.	DATE	PINELLAS PARK, FLA. 33781 U.S.A.	1 OF 1	01/03/23
	INCH	METRIC																			
3 PLACE	± .005	± ---																			
2 PLACE	± .01	± 0.13																			
1 PLACE	± ---	± 0.25																			
molex ETC INC.	SHEET NO.	DATE																			
PINELLAS PARK, FLA. 33781 U.S.A.	1 OF 1	01/03/23																			
DRAFT WHERE APPLICABLE MUST REMAIN WITHIN DIMENSIONS		PART NO. SEE TABLE																			
<table border="1"> <tr> <td>DRWG. BY</td> <td>EDB</td> <td>CHK'D. BY</td> <td>HEB</td> </tr> <tr> <td>APP'D. BY</td> <td>RWD</td> <td>SCALE</td> <td>NO: NE</td> </tr> </table>		DRWG. BY	EDB	CHK'D. BY	HEB	APP'D. BY	RWD	SCALE	NO: NE	<table border="1"> <tr> <td>FILE NAME</td> <td>DRWG. NO.</td> </tr> <tr> <td>SD19057005 DGN</td> <td>SD-19057-005</td> </tr> </table>		FILE NAME	DRWG. NO.	SD19057005 DGN	SD-19057-005						
DRWG. BY	EDB	CHK'D. BY	HEB																		
APP'D. BY	RWD	SCALE	NO: NE																		
FILE NAME	DRWG. NO.																				
SD19057005 DGN	SD-19057-005																				
THIS DRAWING CONTAINS INFORMATION THAT IS PROPRIETARY TO MOLEX-ETC INC. AND SHOULD NOT BE USED WITHOUT WRITTEN PERMISSION.		DIV.	SIZE																		
		ET	B																		