

Introducing
Corcom GG/HG Series
10 Amp & Wire Ledged Options

KEY FEATURES

- Filtered Medical and General Purpose Power Entry Modules
- Compact Size
- 1-10A Current Rating
- Single/Dual Fuse
- Rated to 250 VAC
- UL Recognized, CSA Certified and VDE Approved
- RoHS Compliant

DESCRIPTION

Tyco Electronics has extended the Corcom GG/HG power entry modules series to include a 10 amp current rating for all versions within the series and a 5" wire lead option for the HG series.

The GG series of power entry modules combine the functions of a general purpose RFI filter with an IEC power cord connector and single or dual metric fusing.

The HG series is the medical version of the GG series with reduced line-to-ground capacitance to meet patient care equipment requirements.

APPLICATIONS

Communication Equipment	Instrumentation and Medical Equipment
Computer & Consumer Electronics	Portable Electronic Devices
Light Industrial	Vending and Exercise Equipment

ELECTRICAL

Maximum leakage current, each line-to-ground

GG Model : @ 120 VAC 60 Hz : .25mA & @250 VAC 50 Hz : .42mA

HG Models : @ 120 VAC 60 Hz : 2µA & @250 VAC 50 Hz : 5µA

Hipot rating (one minute)

Line to ground : 1550 VAC

Line to line : 1450 VDC

Rated currents : 1, 3, 6 & 10 Amps

Rated Voltage (max) : 250 VAC

Operating Frequency : 50/60 HZ

Fuse (not included) : -1 model, one 5 x 20 mm fuse, -2 model, two 5 x 20 mm fuses

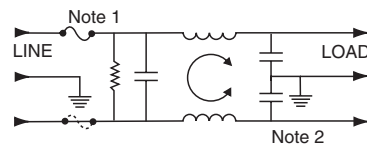

Note 1 : Depicts single fuse for -1 models

Note 2 : For HG delete line-to-ground capacitors

STANDARD AND SPECS

UL Listed, CSA Certified, VDE Approved

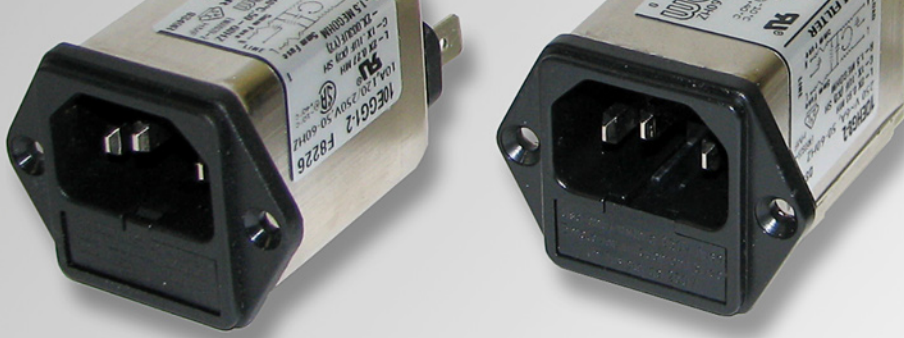

Corcom GG/HG Series 10 Amp & Wire Ledged Options

MINIMUM INSERTION LOSS

Line-to-ground in 50 ohm Circuit

Filter	.01	.05	.1	.15	.5	1	5	10	30
10A GG	-	1	2	4	6	8	26	33	28
10A HG	1	1	1	3	5	6	8	9	10
10A HGS	-	1	2	4	5	6	7	7	7

Line-to-line in 50 ohm Circuit

Filter	.01	.05	.1	.15	.5	1	5	10	30
10A GG	-	2	4	7	17	23	22	43	38
10A HG	3	3	3	8	16	22	37	43	28
10A HGS	1	2	3	6	16	22	37	45	43

PRODUCT DIMENSIONS

GG1/HG1

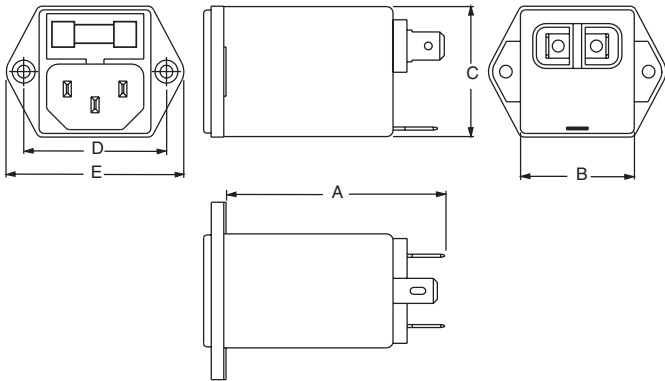

GG8/HG8

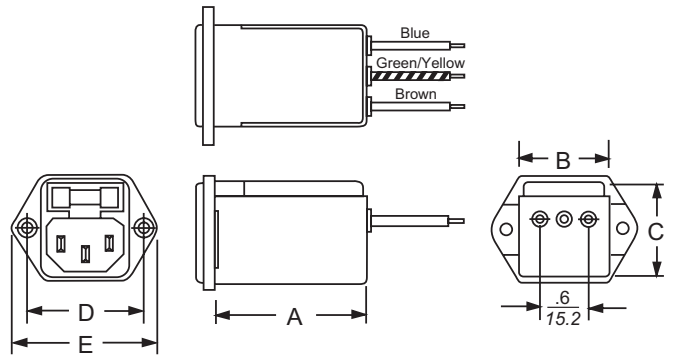

EGS/EHGS

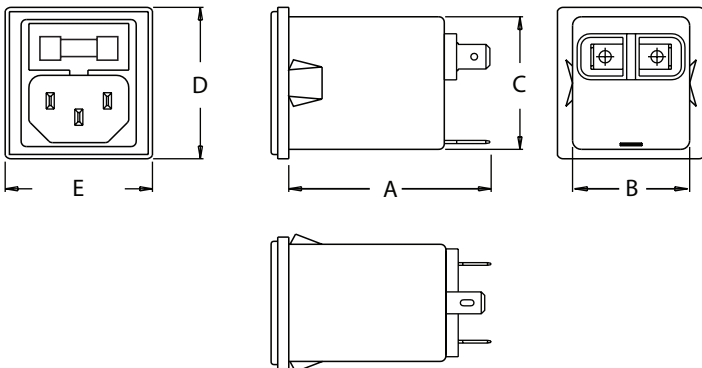

Part Number	A (max)	B (max)	C (max)	D ± .015	E (max)
GG1 HG1	2.15	1.13	1.29	1.42	1.76
GG8 HG8	2.02	1.13	1.29	1.42	1.76
EGS EHGS	2.13	1.13	1.28	1.46	1.42

*Dimensions are in inches.

**Dimensions are shown for reference purposes only. Specifications are subject to change.

FOR MORE INFORMATION

Technical Support

Internet:	www.tycoelectronics.com/help www.corcom.com
E-mail:	newproducts@tycoelectronics.com
USA:	+1 (800) 522-6752
Canada:	+1 (905) 470-4425
Mexico & Central America:	+ 52(0) 55-1106-0814
South America:	+55 (0) 11-2103-6000
Germany:	+49 (0) 6251-133-1999
UK:	+ 44 (0) 8706-080208
France:	+33 (0) 1-3420-8686
Netherlands:	+31 (0) 73-6246-999
China:	+86 (0) 400-820-6015

Tyco Electronics Corporation
Harrisburg, PA

tycoelectronics.com

©2009 Tyco Electronics Corporation
4-1773454-7 2/2009

CORCOM, TE logo and Tyco Electronics are trademarks.

While Tyco Electronics has made every reasonable effort to ensure the accuracy of the information in this catalog, Tyco Electronics does not guarantee that it is error-free, nor does Tyco Electronics make any other representation, warranty or guarantee that the information is accurate, correct, reliable or current. Tyco Electronics reserves the right to make any adjustments to the information contained herein at any time without notice. Tyco Electronics expressly disclaims all implied warranties regarding the information contained herein, including, but not limited to, any implied warranties of merchantability or fitness for a particular purpose. The dimensions in this catalog are for reference purposes only and are subject to change without notice. Specifications are subject to change without notice. Consult Tyco Electronics for the latest dimensions and design specifications.

 **Tyco Electronics**
Our commitment. Your advantage.