

THIS DOCUMENT IS THE PROPERTY OF
KEYSTONE ELECTRONICS CORP. AND
SHALL NOT BE REPRODUCED, DISTRIBUTED
OR USED AS A BASIS FOR MANUFACTURE
WITHOUT PRIOR WRITTEN PERMISSION
FROM KEYSTONE ELECTRONICS CORP.

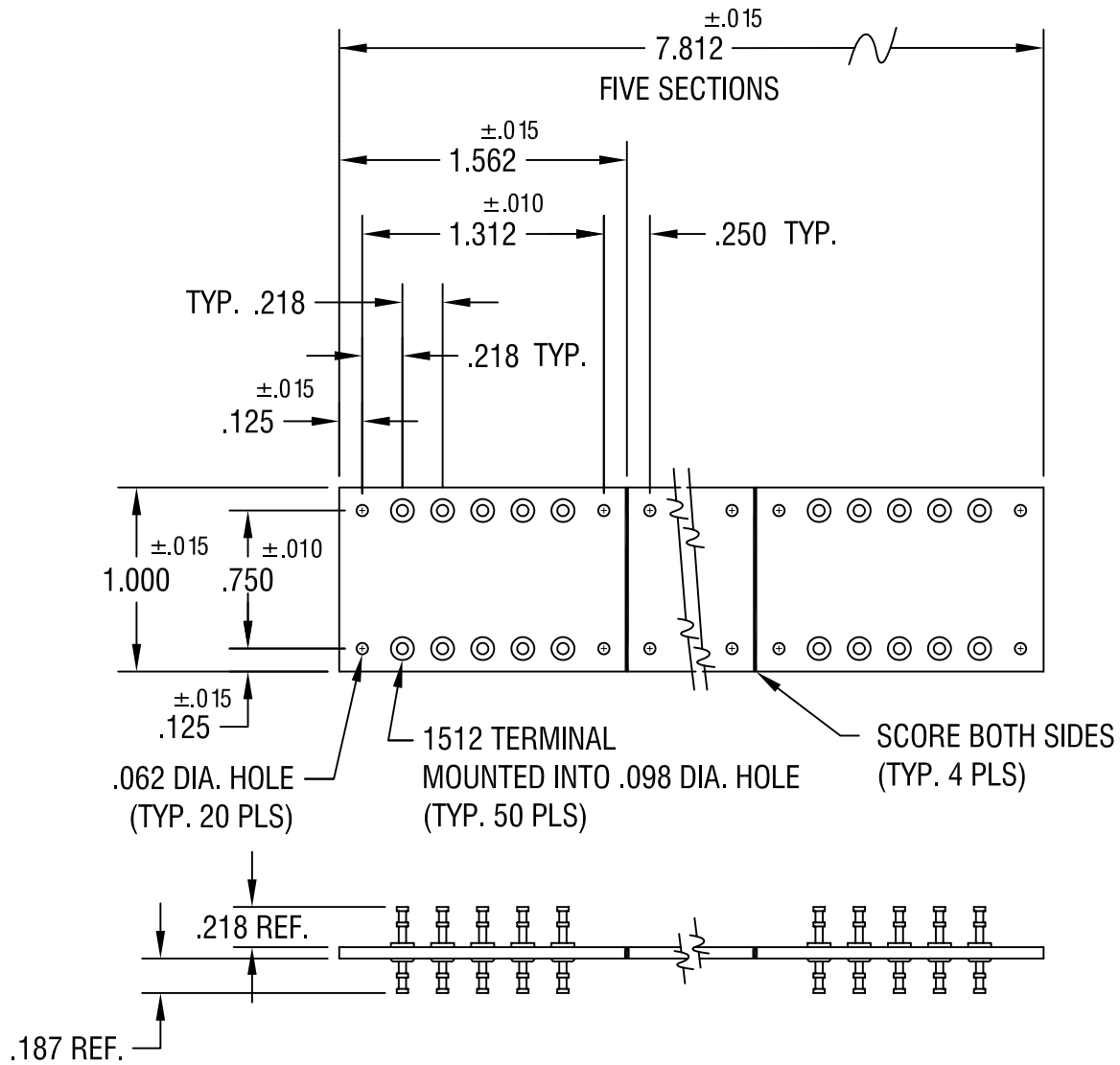

KEYSTONE ELECTRONICS CORP.			
ASTORIA, N.Y. 11105-2017			
PART NAME			
MINIATURE TURRET TERMINAL BOARD			
MATERIAL			
.062 TH'K G-10 GLASS EPOXY			
FINISH		DRN BY	DATE
AS NOTED		BOONE	1.6.82
		APP'D	SCALE
		LN	1X
TOLERANCES	INCH [MM]	CODE	DWG NO.
DECIMAL	±.005 [±]	C/M	15265
ANGULAR	± 1°		
UNLESS OTHERWISE SPECIFIED			

5.5.05	REVISED	A
DATE	DESCRIPTION	REV.