

2-Mbit (128K x 16) Static RAM

Features

- **Very high speed**
 - 55 ns
- **Temperature Ranges**
 - Industrial: - 40°C to + 85°C
 - Automotive: - 40°C to + 125°C
- **Pin-compatible with the CY62137V**
- **Ultra-low active power**
 - Typical active current: 1.5 mA @ f = 1 MHz
 - Typical active current: 7 mA @ f = f_{Max} (55 ns speed)
- **Low and ultra-low standby power**
- **Easy memory expansion with \overline{CE} and \overline{OE} features**
- **Automatic power-down when deselected**
- **CMOS for optimum speed/power**
- **Available in Pb-free and non Pb-free 48-ball FBGA package**

Functional Description^[1]

The CY62137CV30/33 and CY62137CV are high-performance CMOS static RAMs organized as 128K words by 16 bits. These devices feature advanced circuit design to provide

ultra-low active current. This is ideal for providing More Battery Life™ (MoBL[®]) in portable applications such as cellular telephones. The devices also has an automatic power-down feature that significantly reduces power consumption by 80% when addresses are not toggling. The device can also be put into standby mode reducing power consumption by more than 99% when deselected (\overline{CE} HIGH or both \overline{BLE} and \overline{BHE} are HIGH). The input/output pins (I/O_0 through I/O_{15}) are placed in a high-impedance state when: deselected (\overline{CE} HIGH), outputs are disabled (\overline{OE} HIGH), both Byte High Enable and Byte Low Enable are disabled (\overline{BHE} , \overline{BLE} HIGH), or during a write operation (\overline{CE} LOW, and \overline{WE} LOW).

Writing to the device is accomplished by taking Chip Enable (\overline{CE}) and Write Enable (\overline{WE}) inputs LOW. If Byte Low Enable (\overline{BLE}) is LOW, then data from I/O pins (I/O_0 through I/O_7), is written into the location specified on the address pins (A_0 through A_{16}). If Byte High Enable (\overline{BHE}) is LOW, then data from I/O pins (I/O_8 through I/O_{15}) is written into the location specified on the address pins (A_0 through A_{16}).

Reading from the device is accomplished by taking Chip Enable (\overline{CE}) and Output Enable (\overline{OE}) LOW while forcing the Write Enable (\overline{WE}) HIGH. If Byte Low Enable (\overline{BLE}) is LOW, then data from the memory location specified by the address pins will appear on I/O_0 to I/O_7 . If Byte High Enable (\overline{BHE}) is LOW, then data from memory will appear on I/O_8 to I/O_{15} . See the truth table at the back of this data sheet for a complete description of read and write modes.

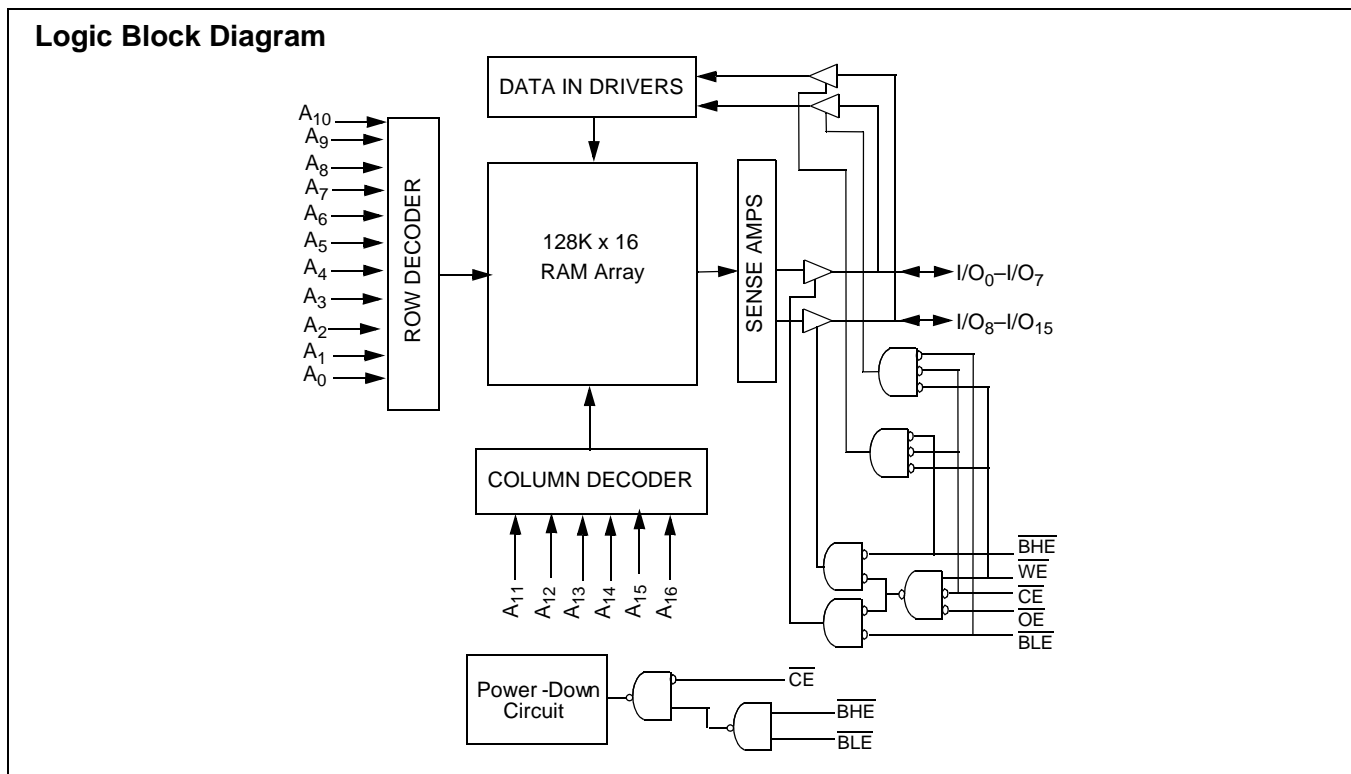

Note:

1. For best practice recommendations, please refer to the Cypress application note "System Design Guidelines" on <http://www.cypress.com>.

Product Portfolio

Product	Range	V _{CC} Range (V)			Speed (ns)	Power Dissipation					
						Operating, I _{CC} (mA)				Standby, I _{SB2} (μA)	
		Min.	Typ. ^[2]	Max.		f = 1 MHz		f = f _{Max}			
						Typ. ^[2]	Max.	Typ. ^[2]	Max.	Typ. ^[2]	Max.
CY62137CV30LL	Industrial	2.7	3.0	3.3	55	1.5	3	7	15	2	10
					70	1.5	3	5.5	12		
CY62137CV30LL	Automotive	2.7	3.0	3.3	70	1.5	3	5.5	15	2	15
CY62137CV33LL	Industrial	3.0	3.3	3.6	55	1.5	3	7	15	5	15
CY62137CVSL	Industrial	2.7	3.3	3.6	70	1.5	3	5.5	12	1	5

Pin Configuration^[3, 4]

**48-ball VFBGA
Top View**

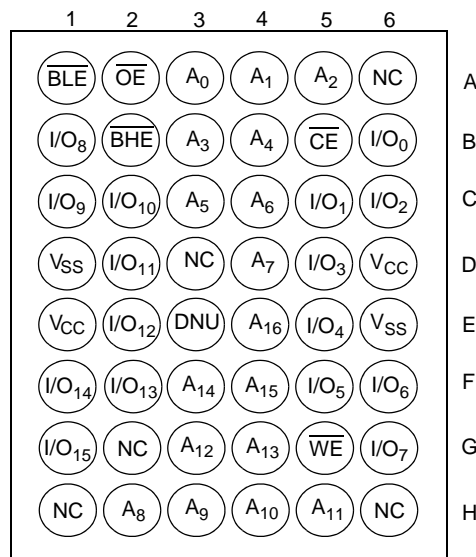

Notes:

- Typical values are included for reference only and are not guaranteed or tested. Typical values are measured at V_{CC} = V_{CC(typ.)}, T_A = 25°C.
- NC pins are not connected to the die.
- E3 (DNU) pin have to be left floating or tied to V_{SS} to ensure proper operation.



Maximum Ratings

(Above which the useful life may be impaired. For user guidelines, not tested.)

- Storage Temperature-65°C to +150°C
- Ambient Temperature with Power Applied.....-55°C to +125°C
- Supply Voltage to Ground Potential -0.5V to $V_{CC(max)} + 0.5V$
- DC Voltage Applied to Outputs in High-Z State^[5] -0.5V to $V_{CC} + 0.3V$
- DC Input Voltage^[5]..... -0.5V to $V_{CC} + 0.3V$
- Output Current into Outputs (LOW)20 mA

Static Discharge Voltage..... > 2001V (per MIL-STD-883, Method 3015)

Latch-up Current..... > 200 mA

Operating Range

Device	Range	Ambient Temperature T_A	V_{CC}
CY62137CV30	Industrial	-40°C to +85°C	2.7V to 3.3V
CY62137CV33			3.0V to 3.6V
CY62137CV			2.7V to 3.6V
CY62137CV30	Automotive	-40°C to +125°C	2.7V to 3.3V

Electrical Characteristics Over the Operating Range

Parameter	Description	Test Conditions	CY62137CV30-55			CY62137CV30-70			Unit		
			Min.	Typ. ^[2]	Max.	Min.	Typ. ^[2]	Max.			
V_{OH}	Output HIGH Voltage	$I_{OH} = -1.0 \text{ mA}$ $V_{CC} = 2.7V$	2.4			2.4			V		
V_{OL}	Output LOW Voltage	$I_{OL} = 2.1 \text{ mA}$ $V_{CC} = 2.7V$			0.4			0.4	V		
V_{IH}	Input HIGH Voltage		2.2		$V_{CC} + 0.3$	2.2		$V_{CC} + 0.3$	V		
V_{IL}	Input LOW Voltage		-0.3		0.8	-0.3		0.8	V		
I_{IX}	Input Leakage Current	$GND \leq V_I \leq V_{CC}$	Ind'l	-1	+1	-1		+1	μA		
			Auto			-2		+2			
I_{OZ}	Output Leakage Current	$GND \leq V_O \leq V_{CC}$, Output Disabled	Ind'l	-1	+1	-1		+1	μA		
			Auto			-2		+2			
I_{CC}	V_{CC} Operating Supply Current	$f = f_{Max} = 1/t_{RC}$	$V_{CC} = 3.3V$ $I_{OUT} = 0mA$ CMOS Levels	Ind'l		7	15		5.5	12	mA
				Auto					5.5	15	
		$f = 1 \text{ MHz}$	Ind'l		1.5	3		1.5	3		
			Auto					1.5	3		
I_{SB1}	Automatic CE Power-down Current — CMOS Inputs	$\overline{CE} \geq V_{CC} - 0.2V$ $V_{IN} \geq V_{CC} - 0.2V$ or $V_{IN} \leq 0.2V$, $f = f_{Max}$ (Address and Data only), $f=0$ (\overline{OE} , \overline{WE} , \overline{BHE} and \overline{BLE})	Ind'l		2	10		2	10	μA	
			Auto					2	15		
I_{SB2}	Automatic CE Power-down Current — CMOS Inputs	$\overline{CE} \geq V_{CC} - 0.2V$ $V_{IN} \geq V_{CC} - 0.2V$ or $V_{IN} \leq 0.2V$ $f = 0, V_{CC} = 3.3V$	Ind'l		2	10		2	10	μA	
			Auto					2	15		

Note:

5. $V_{IL(min.)} = -2.0V$ for pulse durations less than 20 ns.

Electrical Characteristics Over the Operating Range (continued)

Parameter	Description	Test Conditions	CY62137CV33-55			CY62137CV-70			Unit	
			Min.	Typ. ^[2]	Max.	Min.	Typ. ^[2]	Max.		
V _{OH}	Output HIGH Voltage	I _{OH} = -1.0 mA	V _{CC} = 3.0V	2.4			2.4		V	
			V _{CC} = 2.7V				2.4		V	
V _{OL}	Output LOW Voltage	I _{OL} = 2.1 mA	V _{CC} = 3.0V			0.4			0.4	V
			V _{CC} = 2.7V						0.4	V
V _{IH}	Input HIGH Voltage		2.2		V _{CC} +0.3	2.2		V _{CC} +0.3	V	
V _{IL}	Input LOW Voltage		-0.3		0.8	-0.3		0.8	V	
I _{IX}	Input Leakage Current	GND ≤ V _I ≤ V _{CC}	-1		+1	-1		+1	μA	
I _{OZ}	Output Leakage Current	GND ≤ V _O ≤ V _{CC} , Output Disabled	-1		+1	-1		+1	μA	
I _{CC}	V _{CC} Operating Supply Current	f = f _{Max} = 1/t _{RC}	V _{CC} = 3.6V		7	15		5.5	12	mA
		f = 1 MHz	I _{OUT} = 0 mA CMOS Levels		1.5	3		1.5	3	
I _{SB1}	Automatic CE Power-down Current —CMOS Inputs	$\overline{CE} \geq V_{CC} - 0.2V$ $V_{IN} \geq V_{CC} - 0.2V$ or $V_{IN} \leq 0.2V$, $f = f_{Max}$ (Address and Data Only), $f=0$ (OE, WE, BHE, and BLE)		5	15		5	15	μA	
I _{SB2}	Automatic CE Power-down Current —CMOS Inputs	$\overline{CE} \geq V_{CC} - 0.2V$ $V_{IN} \geq V_{CC} - 0.2V$ or $V_{IN} \leq 0.2V, f = 0, V_{CC} = 3.6V$	LL		5	15		5	15	μA
			SL		5	15		1	5	

Capacitance^[6]

Parameter	Description	Test Conditions	Max.	Unit
C _{IN}	Input Capacitance	T _A = 25°C, f = 1 MHz, V _{CC} = V _{CC} (typ.)	6	pF
C _{OUT}	Output Capacitance		8	pF

Thermal Resistance^[6]

Parameter	Description	Test Conditions	FBGA	Unit
θ _{JA}	Thermal Resistance (Junction to Ambient)	Still Air, soldered on a 3 x 4.5 inch, 2-layer printed circuit board	55	°C/W
θ _{JC}	Thermal Resistance (Junction to Case)		16	°C/W

Note:

6. Tested initially and after any design or process changes that may affect these parameters.

AC Test Loads and Waveforms

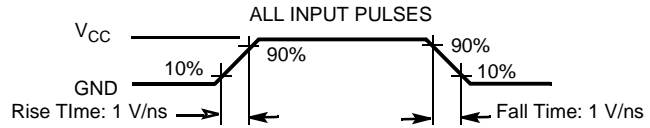
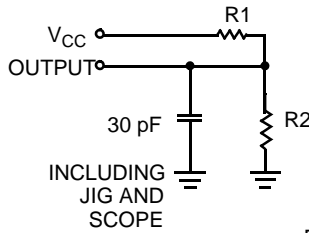

Equivalent to: THEVENIN EQUIVALENT

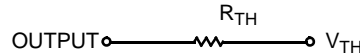

Parameters	3.0V	3.3V	Unit
R1	1105	1216	Ω
R2	1550	1374	Ω
R _{TH}	645	645	Ω
V _{TH}	1.75	1.75	V

Data Retention Characteristics (Over the Operating Range)

Parameter	Description	Conditions	Min.	Typ. ^[4]	Max.	Unit
V _{DR}	V _{CC} for Data Retention		1.5		V _{CC(max)}	V
I _{CCDR}	Data Retention Current	V _{CC} = 1.5V CE ≥ V _{CC} - 0.2V, V _{IN} ≥ V _{CC} - 0.2V or V _{IN} ≤ 0.2V		1	6	μA
		LL	Ind'l		8	
		SL	Ind'l		4	
t _{CDR} ^[6]	Chip Deselect to Data Retention Time		0			ns
t _R ^[7]	Operation Recovery Time		t _{RC}			ns

Data Retention Waveform^[8]

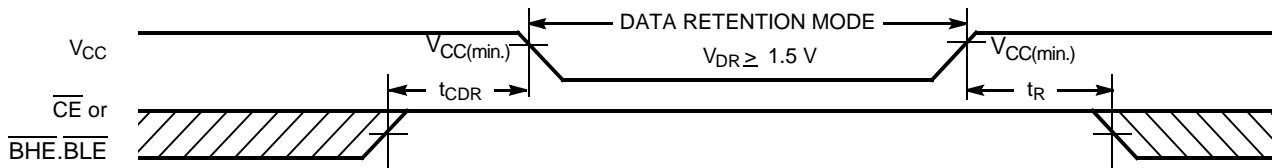

Notes:

7. Full-device AC operation requires linear V_{CC} ramp from V_{DR} to V_{CC(min.)} > 100 μs or stable at V_{CC(min.)} > 100 μs.
8. BHE.BLE is the AND of both BHE and BLE. Chip can be deselected by either disabling the chip enable signals or by disabling both BHE and BLE.

Switching Characteristics Over the Operating Range^[9]

Parameter	Description	55 ns		70 ns		Unit
		Min.	Max.	Min.	Max.	
Read Cycle						
t _{RC}	Read Cycle Time	55		70		ns
t _{AA}	Address to Data Valid		55		70	ns
t _{OHA}	Data Hold from Address Change	10		10		ns
t _{ACE}	\overline{CE} LOW to Data Valid		55		70	ns
t _{DOE}	\overline{OE} LOW to Data Valid		25		35	ns
t _{LZOE}	\overline{OE} LOW to Low-Z ^[10]	5		5		ns
t _{HZOE}	\overline{OE} HIGH to High-Z ^[10, 12]		20		25	ns
t _{LZCE}	\overline{CE} LOW to Low-Z ^[10]	10		10		ns
t _{HZCE}	\overline{CE} HIGH to High-Z ^[10, 12]		20		25	ns
t _{PU}	\overline{CE} LOW to Power-up	0		0		ns
t _{PD}	\overline{CE} HIGH to Power-down		55		70	ns
t _{DBE}	$\overline{BHE}/\overline{BLE}$ LOW to Data Valid		55		70	ns
t _{LZBE} ^[11]	$\overline{BHE}/\overline{BLE}$ LOW to Low-Z ^[10]	5		5		ns
t _{HZBE}	$\overline{BHE}/\overline{BLE}$ HIGH to High-Z ^[10, 12]		20		25	ns
Write Cycle ^[13]						
t _{WC}	Write Cycle Time	55		70		ns
t _{SCE}	\overline{CE} LOW to Write End	45		60		ns
t _{AW}	Address Set-up to Write End	45		60		ns
t _{HA}	Address Hold from Write End	0		0		ns
t _{SA}	Address Set-up to Write Start	0		0		ns
t _{PWE}	\overline{WE} Pulse Width	40		45		ns
t _{BW}	$\overline{BHE}/\overline{BLE}$ Pulse Width	50		60		ns
t _{SD}	Data Set-up to Write End	25		30		ns
t _{HD}	Data Hold from Write End	0		0		ns
t _{HZWE}	\overline{WE} LOW to High-Z ^[10, 12]		20		25	ns
t _{LZWE}	\overline{WE} HIGH to Low-Z ^[10]	10		10		ns

Notes:

9. Test conditions assume signal transition time of 5 ns or less, timing reference levels of $V_{CC(typ.)}/2$, input pulse levels of 0 to $V_{CC(typ.)}$, and output loading of the specified I_{OL}/I_{OH} and 30 pF load capacitance.
10. At any given temperature and voltage condition, t_{HZCE} is less than t_{LZCE}, t_{HZBE} is less than t_{LZBE}, t_{HZOE} is less than t_{LZOE}, and t_{HZWE} is less than t_{LZWE} for any given device.
11. If both byte enables are toggled together this value is 10 ns.
12. t_{HZOE}, t_{HZCE}, t_{HZBE}, and t_{HZWE} transitions are measured when the outputs enter a high impedance state.
13. The internal write time of the memory is defined by the overlap of \overline{WE} , $\overline{CE} = V_{IL}$, \overline{BHE} and/or $\overline{BLE} = V_{IL}$. All signals must be ACTIVE to initiate a write and any of these signals can terminate a write by going INACTIVE. The data input set-up and hold timing should be referenced to the edge of the signal that terminates the write.

Switching Waveforms

Read Cycle No. 1 (Address Transition Controlled)^[14, 15]

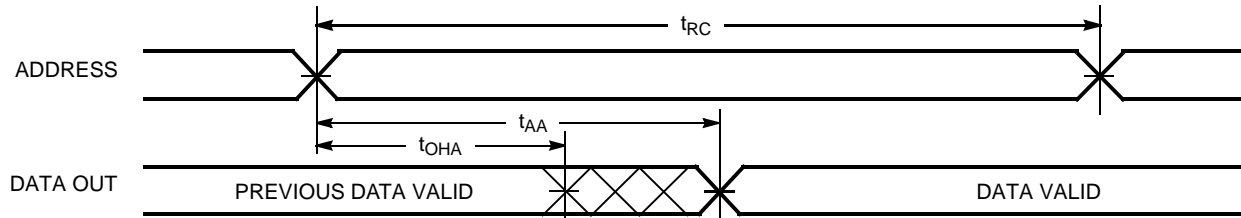

Read Cycle No. 2 ($\overline{\text{OE}}$ Controlled)^[15, 16]

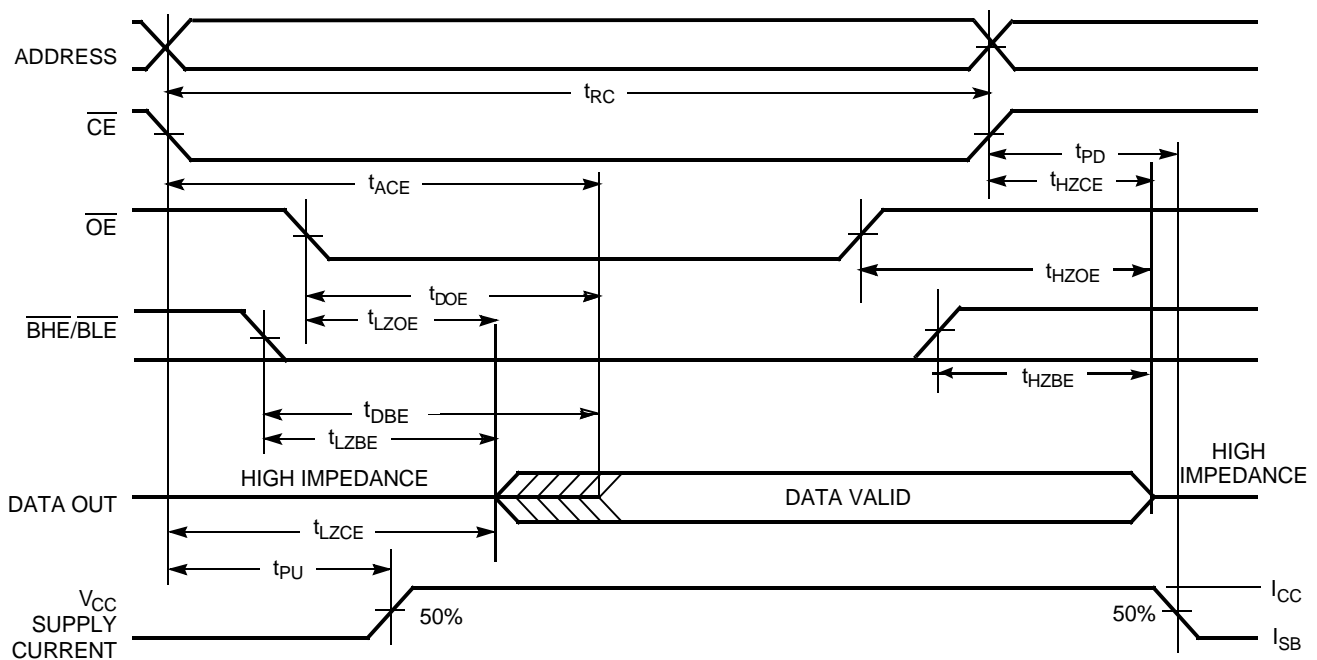

Notes:

- 14. Device is continuously selected. $\overline{\text{OE}}$, $\overline{\text{CE}} = V_{IL}$, $\overline{\text{BHE}}$, $\overline{\text{BLE}} = V_{IL}$.
- 15. $\overline{\text{WE}}$ is HIGH for read cycle.
- 16. Address valid prior to or coincident with $\overline{\text{CE}}$, $\overline{\text{BHE}}$, $\overline{\text{BLE}}$ transition LOW.

Switching Waveforms (continued)

Write Cycle No. 1 (WE Controlled)^[13, 17, 18]

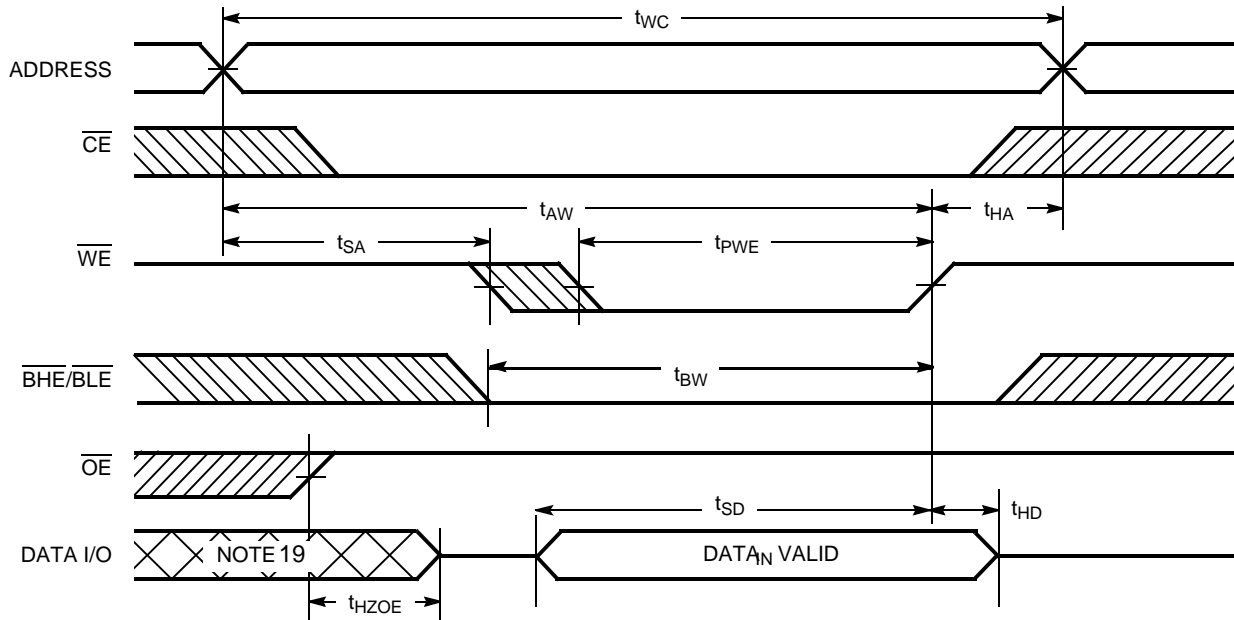

Write Cycle No. 2 (CE Controlled)^[13, 17, 18]

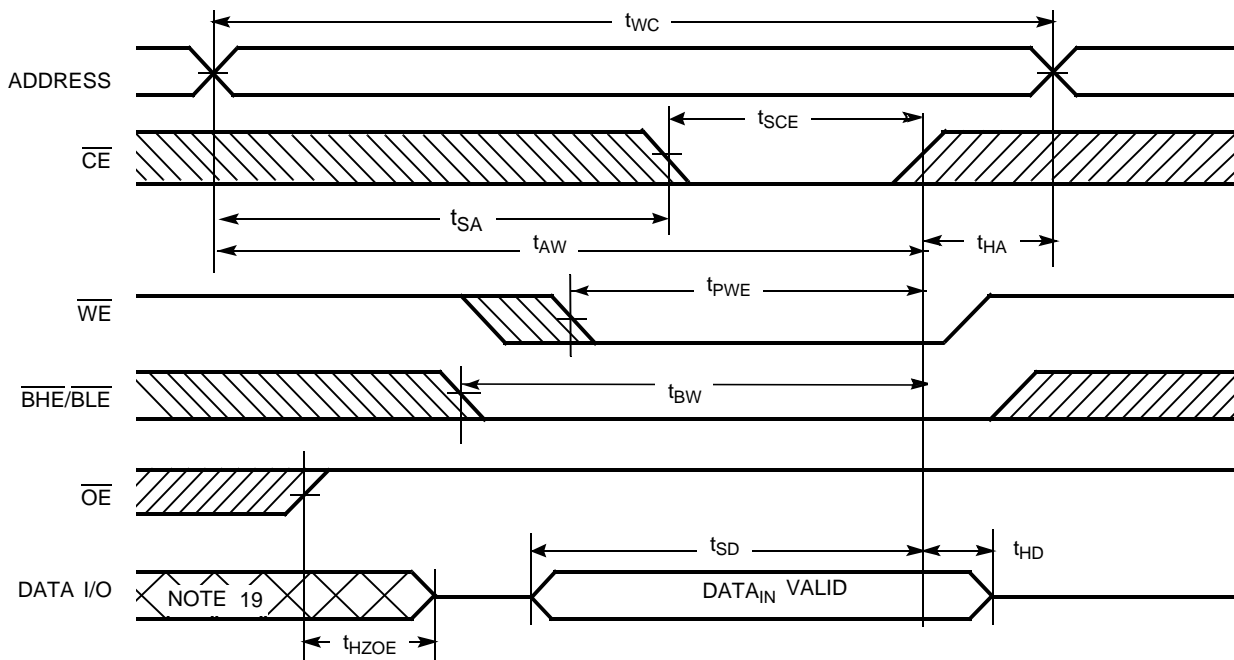

Notes:

- 17. Data I/O is high-impedance if $\overline{OE} = V_{IH}$.
- 18. If CE goes HIGH simultaneously with WE HIGH, the output remains in a high-impedance state.
- 19. During this period, the I/Os are in output state and input signals should not be applied.

Truth Table

\overline{CE}	\overline{WE}	\overline{OE}	\overline{BHE}	\overline{BLE}	Inputs/Outputs	Mode	Power
H	X	X	X	X	High-Z	Deselect/Power-down	Standby (I_{SB})
X	X	X	H	H	High-Z	Deselect/Power-down	Standby (I_{SB})
L	H	L	L	L	Data Out (I/O_0 – I/O_{15})	Read	Active (I_{CC})
L	H	L	H	L	High Z (I/O_8 – I/O_{15}); Data Out (I/O_0 – I/O_7)	Read	Active (I_{CC})
L	H	L	L	H	Data Out (I/O_8 – I/O_{15}); High Z (I/O_0 – I/O_7)	Read	Active (I_{CC})
L	L	X	L	L	Data In (I/O_0 – I/O_{15})	Write	Active (I_{CC})
L	L	X	H	L	High Z (I/O_8 – I/O_{15}); Data In (I/O_0 – I/O_7)	Write	Active (I_{CC})
L	L	X	L	H	Data in (I/O_8 – I/O_{15}); High Z (I/O_0 – I/O_7)	Write	Active (I_{CC})
L	H	H	L	L	High-Z	Output Disabled	Active (I_{CC})
L	H	H	H	L	High-Z	Output Disabled	Active (I_{CC})
L	H	H	L	H	High-Z	Output Disabled	Active (I_{CC})

Ordering Information

Speed (ns)	Ordering Code	Package Diagram	Package Type	Operating Range
55	CY62137CV30LL-55BVI	51-85150	48-ball FBGA (6 x 8 x 1 mm)	Industrial
	CY62137CV30LL-55BVXI		48-ball FBGA (6 x 8 x 1 mm) (Pb-free)	
	CY62137CV33LL-55BVI		48-ball FBGA (6 x 8 x 1 mm)	
70	CY62137CV30LL-70BAI	51-85096	48-ball FBGA (7 x 7 x 1.2 mm)	Industrial
	CY62137CV30LL-70BVI	51-85150	48-ball FBGA (6 x 8 x 1 mm)	
	CY62137CVSL-70BAI	51-85096	48-ball FBGA (7 x 7 x 1.2 mm)	
	CY62137CVSL-70BAXI		48-ball FBGA (7 x 7 x 1.2 mm) (Pb-free)	
	CY62137CV30LL-70BAE	51-85096	48-ball FBGA (7 x 7 x 1.2 mm)	Automotive
	CY62137CV30LL-70BVE	51-85150	48-ball FBGA (6 x 8 x 1 mm)	
	CY62137CV30LL-70BVXE		48-ball FBGA (6 x 8 x 1 mm) (Pb-free)	

Please contact your local Cypress sales representative for availability of these parts

Package Diagrams

48-ball FBGA (7 x 7 x 1.2 mm) (51-85096)

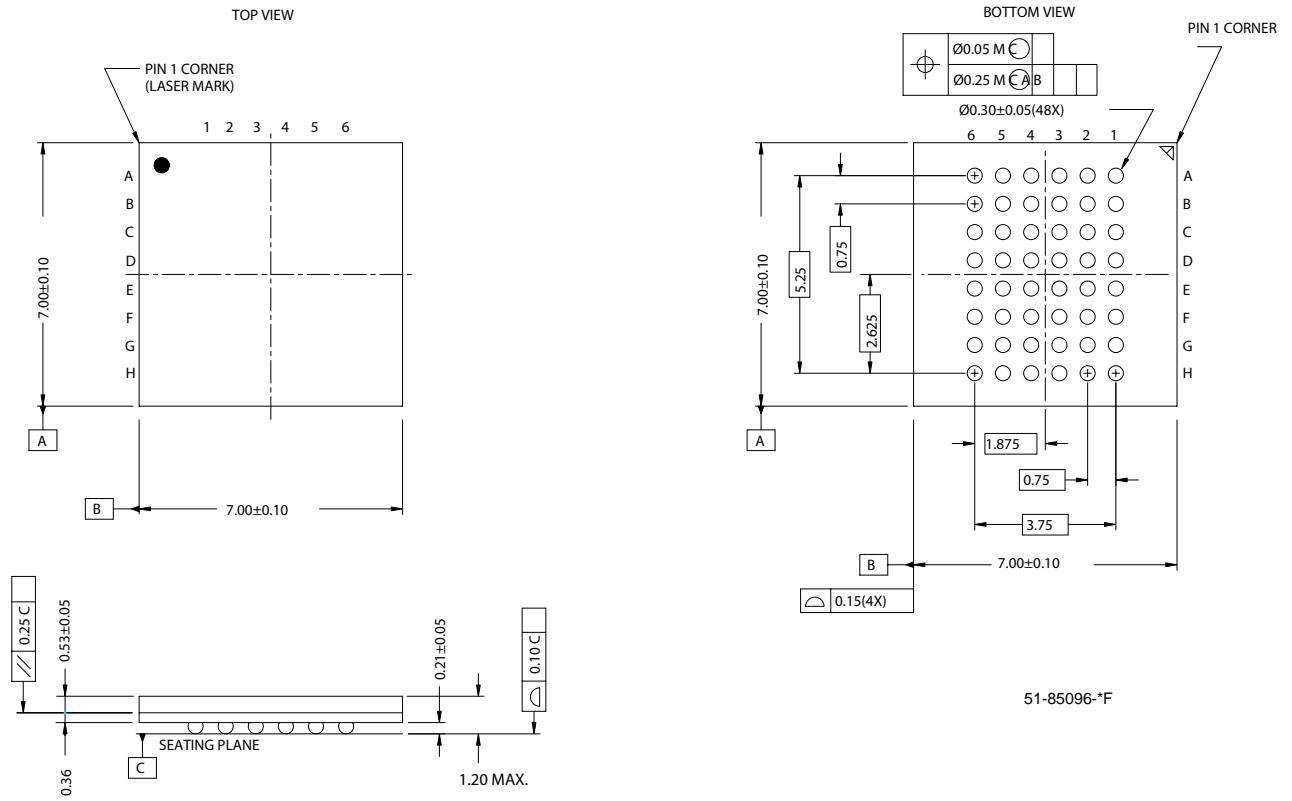

Package Diagrams (continued)

48-ball VFBGA (6 x 8 x 1 mm) (51-85150)

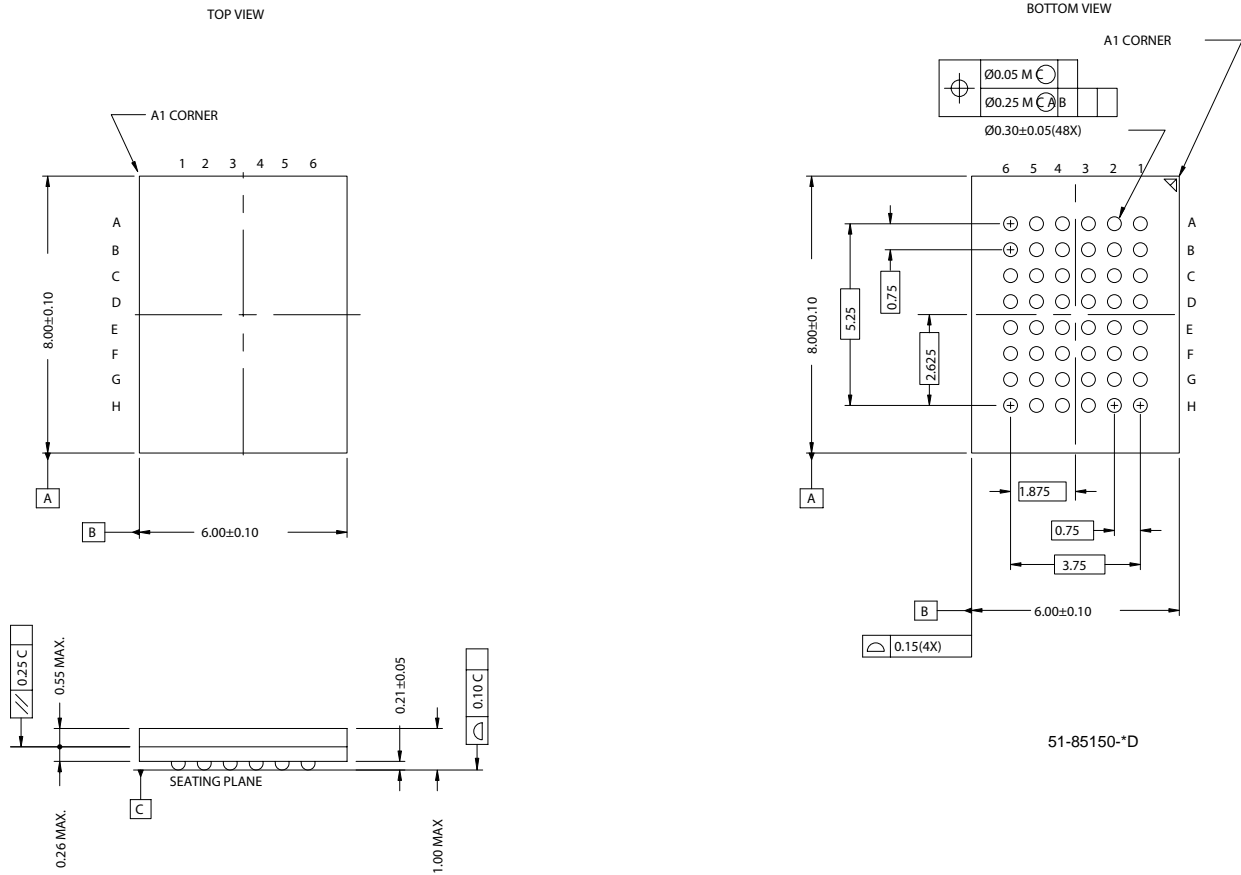

51-85150-D

MoBL is a registered trademark and More Battery Life is a trademark of Cypress Semiconductor Corporation. All product and company names mentioned in this document may be the trademarks of their respective holders.

Document History Page

Document Title: CY62137CV30/33 MoBL® and CY62137CV MoBL® 2-Mbit (128K x 16) Static RAM Document Number: 38-05201				
REV.	ECN NO.	Issue Date	Orig. of Change	Description of Change
**	112393	02/19/02	GAV	New Data Sheet (advance information)
*A	114015	04/25/02	JUI	Added BV package diagram Changed from Advance Information to Preliminary
*B	117064	07/12/02	MGN	Changed from Preliminary to Final
*C	118122	09/10/02	MGN	Added new part number: CY62137CV with wider voltage (2.7V – 3.6V) Added new SL power bin for new part number For T _{AA} = 55 ns, improved t _{PWE} min. from 45 ns to 40 ns For T _{AA} = 70 ns, improved t _{PWE} min. from 50 ns to 45 ns For T _{AA} = 70 ns, improved t _{LZWE} min. from 5 ns to 10 ns
*D	118761	09/23/02	MGN	Improved Typ. I _{CC} spec to 7 mA (for 55 ns) and 5.5 mA (for 70 ns) Improved Max I _{CC} spec to 15 mA (for 55 ns) and 12 mA (for 70 ns) For T _{AA} = 55 ns, improved t _{LZWE} min. from 5 ns to 10 ns Changed upper spec. for Supply Voltage to Ground Potential to V _{CC(max)} + 0.5V Changed upper spec. for DC Voltage Applied to Outputs in High-Z State and DC Input Voltage to V _{CC} + 0.3V
*E	343877	See ECN	PCI	Added Automotive Information in Operating Range, DC and Ordering Information Table
*F	419237	See ECN	ZSD	Changed the address of Cypress Semiconductor Corporation on Page #1 from "3901 North First Street" to "198 Champion Court" Updated the ordering information table and replaced the Package name column with Package diagram
*G	486789	See ECN	VKN	Removed part number CY62137CV25 from the product offering Updated the ordering information table