

LOC		DIST		REVISIONS			
AD	00	P	LTN	DESCRIPTION	DATE	DWN	APVD
		C		REVISED PER ECO-14-005775	22APR2014	AP	DD

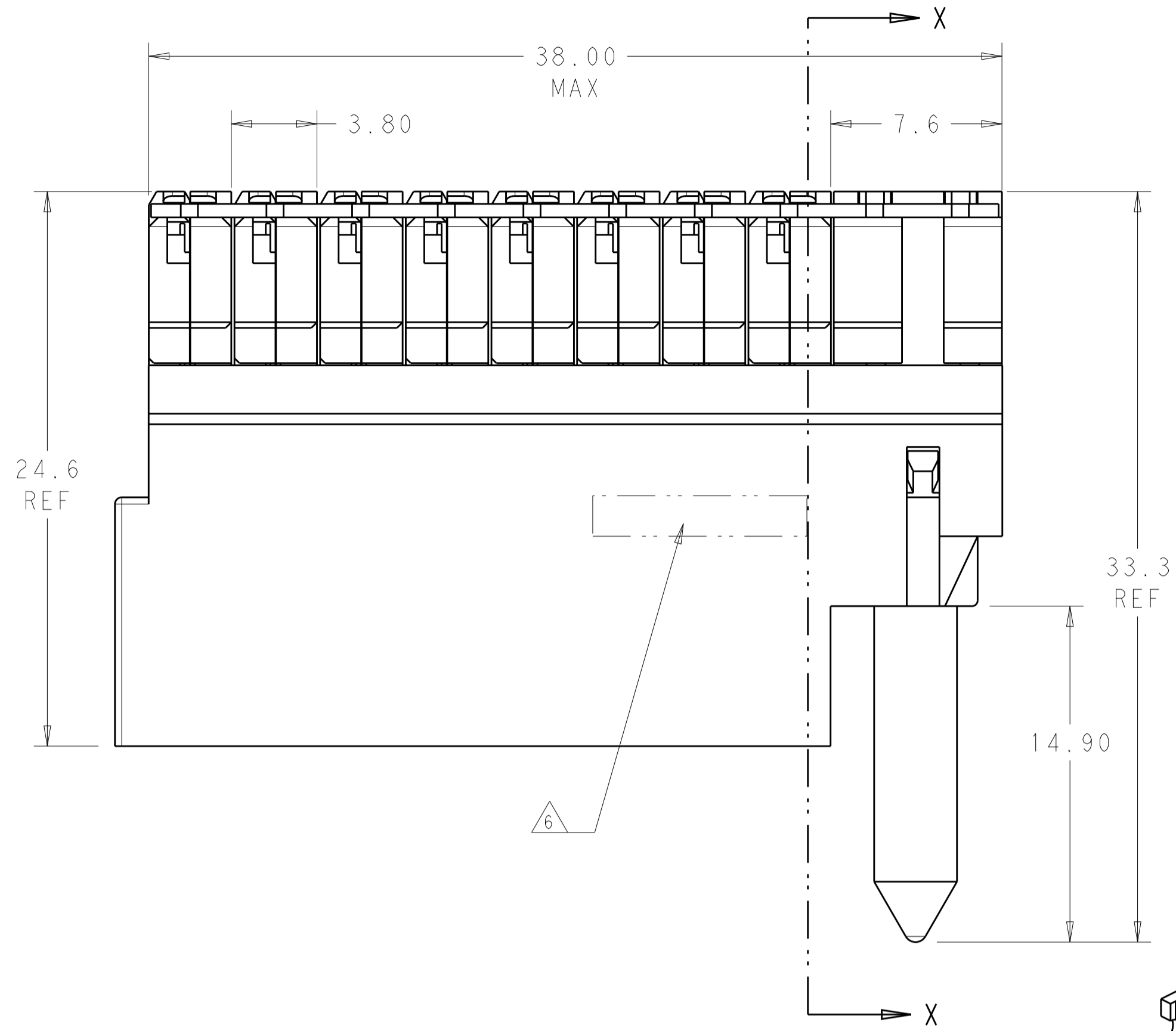

- 1 MATERIAL:
HOUSING: LCP, GLASS FILLED, UL94V-0.
TERMINALS: HIGH PERFORMANCE COPPER ALLOY.
- 2 FINISH:
30µm SELECTIVE GOLD IN CONTACT AREA. SELECTIVE TIN ON PCB TAILS, NICKEL OVERALL.
- 3 FINISH:
30µm SELECTIVE GOLD IN CONTACT AREA. SELECTIVE TIN-LEAD ON PCB TAILS, NICKEL OVERALL.
- 4 RIGHT GUIDED RIGHT ANGLE MALE MATES TO LEFT GUIDED RIGHT ANGLE RECEPTACLE.
- 5. CONNECTOR SUPPLIED WITH MOUNTING SCREW.
- 6 TE LOGO LOCATED IN APPROXIMATE LOCATION.

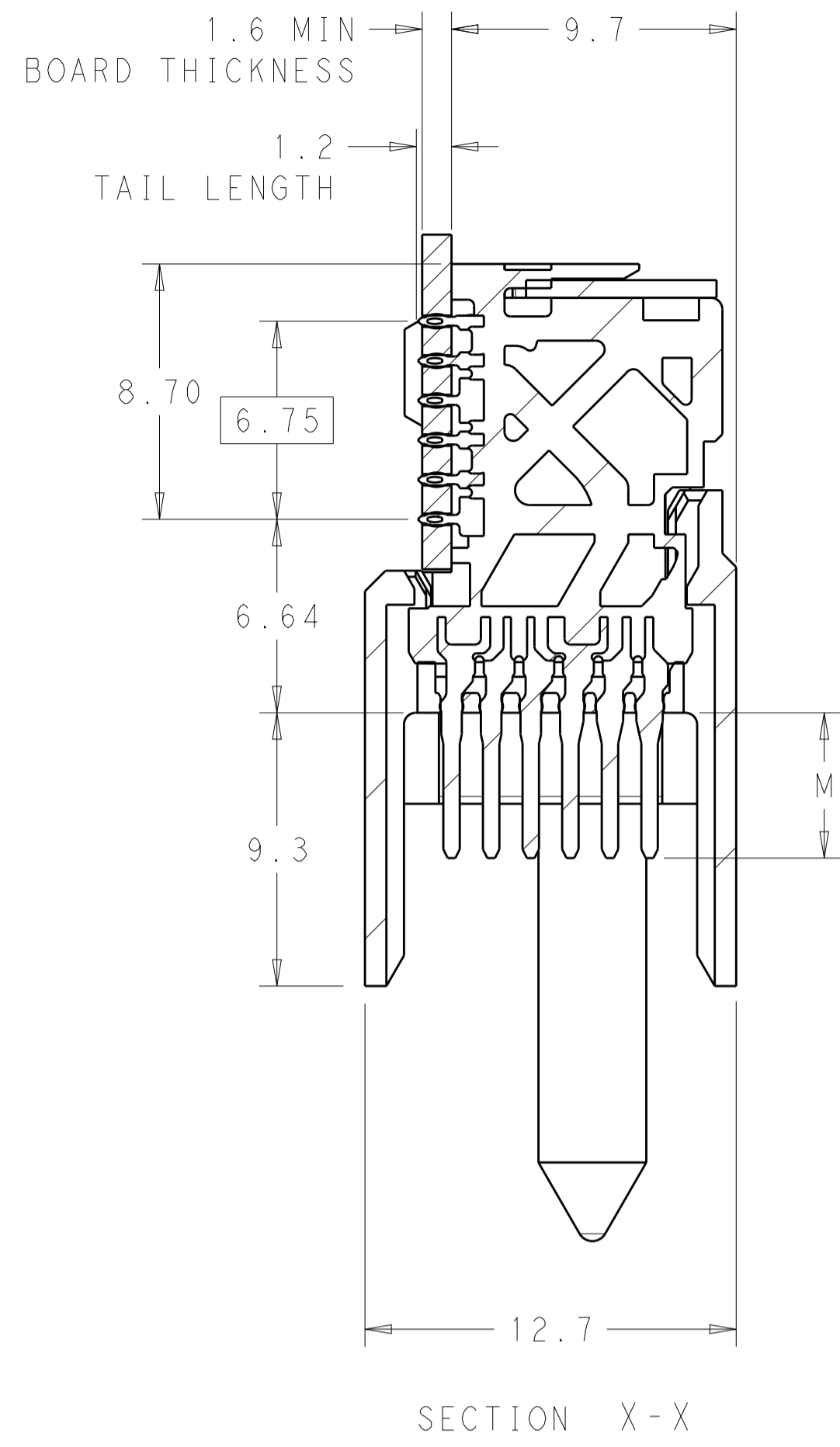
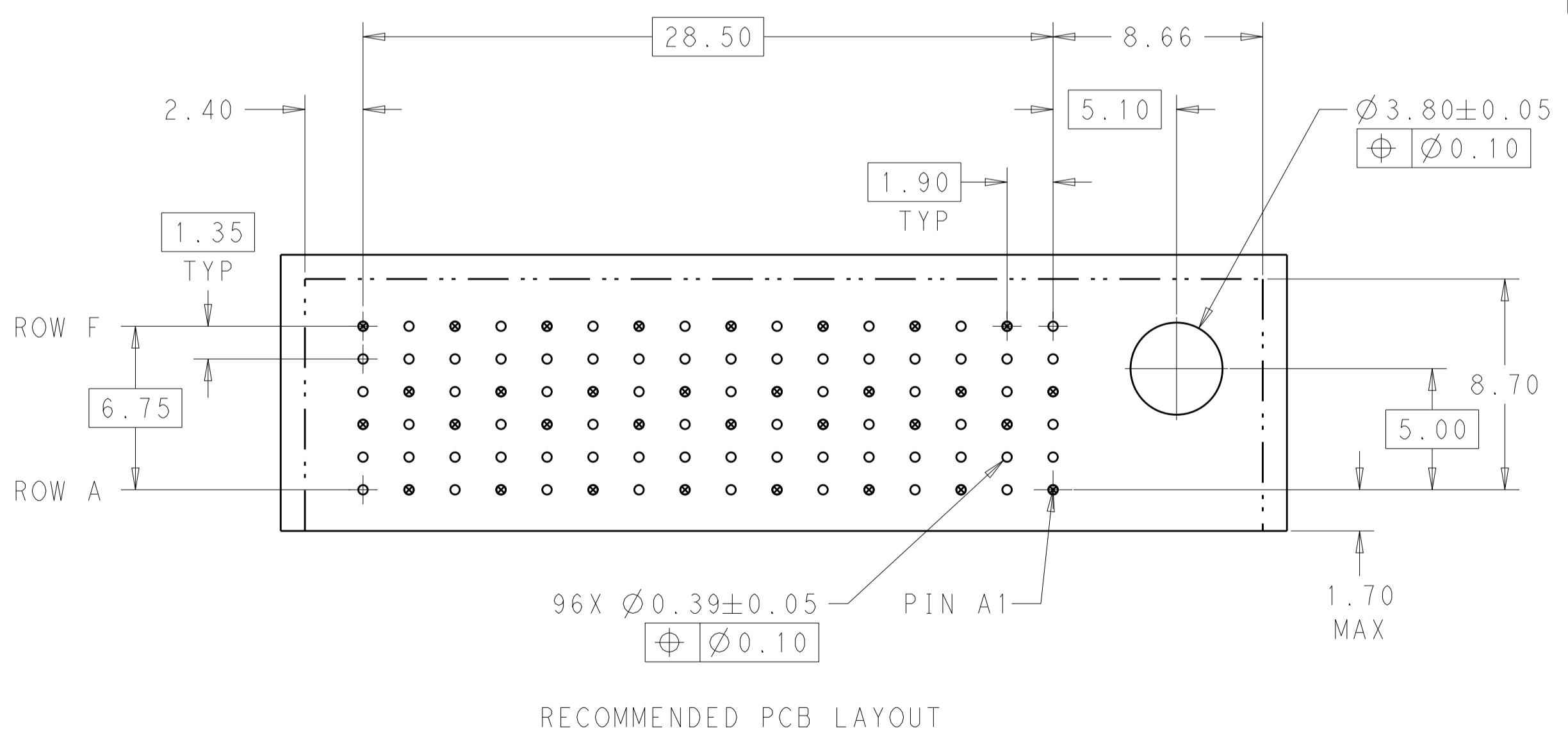
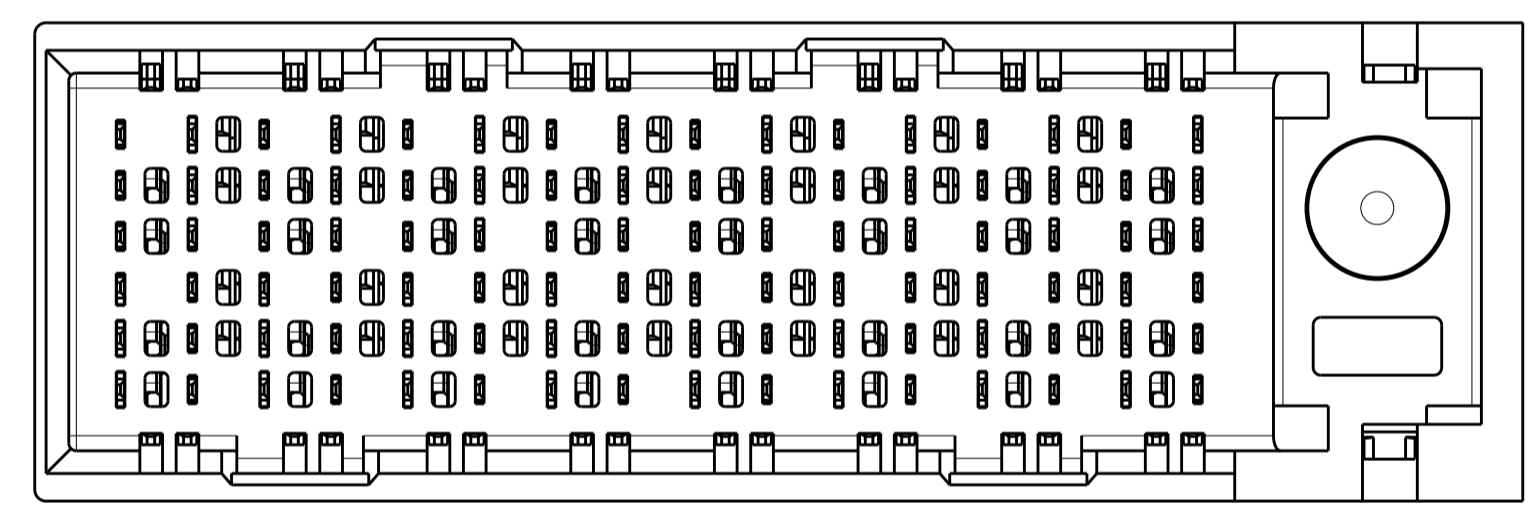
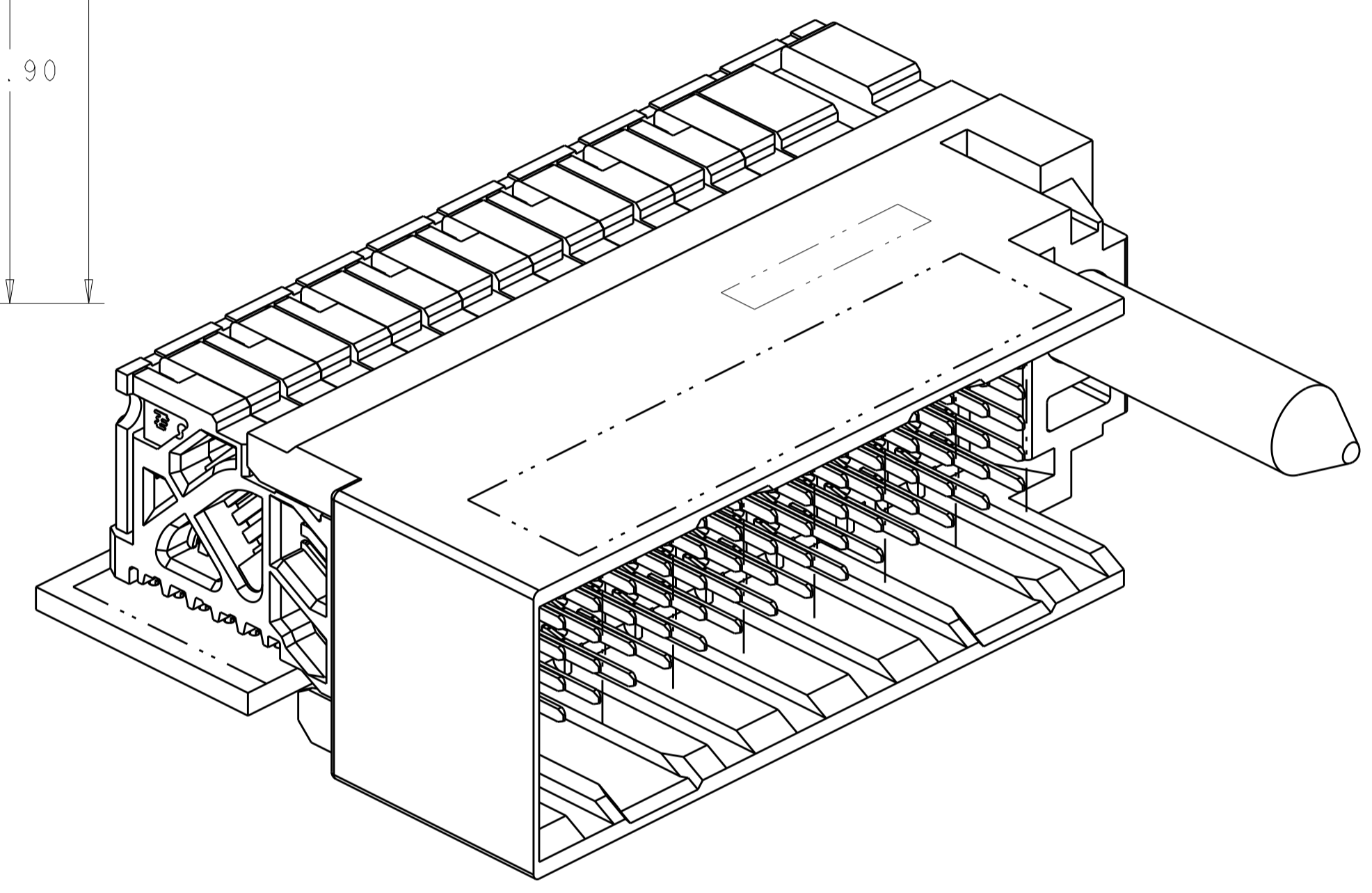

THIS DRAWING IS A CONTROLLED DOCUMENT.		DWN	07APR2011	STE TE Connectivity
DIMENSIONS:		CHK	07APR2011	
mm	TOLERANCES UNLESS OTHERWISE SPECIFIED:	APVD	07APR2011	NAME IMPACT, STD. RAM, 2 PAIR, 16 COLUMN, RIGHT GUIDED LEFT END WALL SIGNAL MODULE, 0.39 EYELET
Ø	0 PLC ±	PRODUCT SPEC		
	1 PLC ±0.25	APPLICATION SPEC		SIZE CAGE CODE DRAWING NO
	2 PLC ±0.13	WEIGHT		A100779C=2143316
	3 PLC ±	CUSTOMER DRAWING		SCALE 5:1 SHEET 1 OF 2 REV C
	4 PLC ±			
	ANGLES ±			
MATERIAL	FINISH SEE TABLE			

LOC		DIST		REVISIONS			
P	LTN	DESCRIPTION	DATE	DWN	APVD		
-	-	SEE SHEET 1	-	-	-		

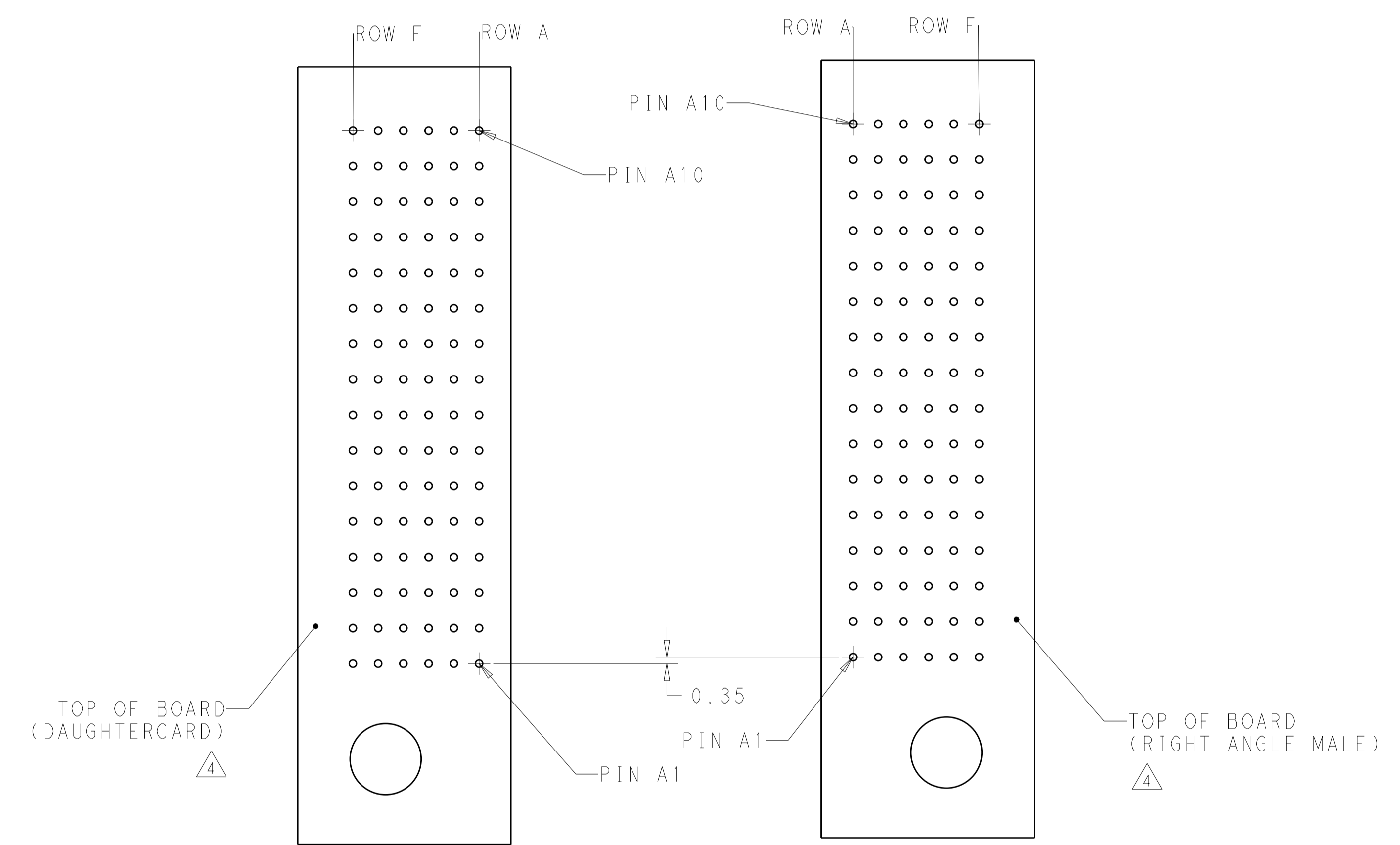

COPLANAR MATED SIGNAL PATHS

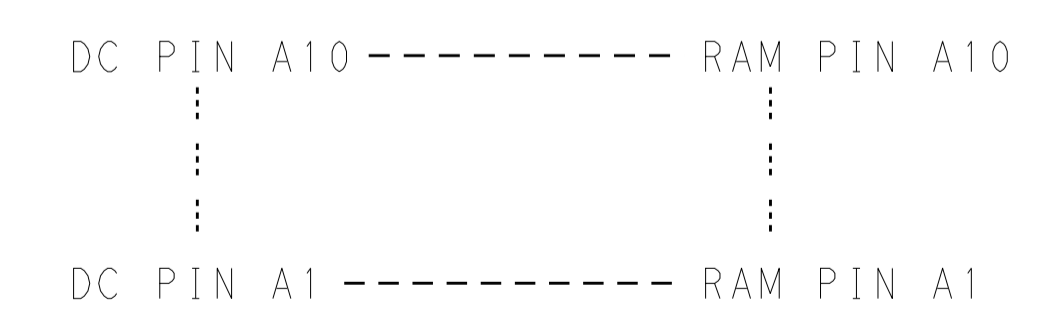

△3	5.50	2143316-6
△3	4.90	2143316-5
△2	5.50	2143316-3
△2	4.90	2143316-2
FINISH	DIM M	PART NUMBER

REFER TO WWW.TE.COM FOR PRODUCT AVAILABILITY

THIS DRAWING IS A CONTROLLED DOCUMENT.		DWN	07APR2011	STE TE Connectivity			
DIMENSIONS:		CHK	J. EARY 07APR2011				
mm		APVD	J. EARY 07APR2011				
TOLERANCES UNLESS OTHERWISE SPECIFIED:		NAME	IMPACT, STD. RAM, 2 PAIR, 16 COLUMN, RIGHT GUIDED LEFT END WALL SIGNAL MODULE, 0.39 EYELET				
0 PLC ±		PRODUCT SPEC		SIZE	CAGE CODE	DRAWING NO	RESTRICTED TO
1 PLC ±0.25		APPLICATION SPEC		A1	00779	2143316	
2 PLC ±0.13				SCALE	5:1	SHEET	2 OF 2
3 PLC ±		WEIGHT		REV	C		
4 PLC ±		CUSTOMER DRAWING					
ANGLES							
FINISH							
SEE TABLE							