

SUMMARY

Wires

Low	8
High	0
Coax	0
Triax	0
Quad	0
Fiber	0
Fluidic	0



Download

[Request a quote](#)

[Catalog](#)

Series

Termination type	Female solder
IP rating	50
Cable Ø	0.00 - 0.00 mm
Matching parts	xxx

TECHNICAL DETAILS

Mechanics

Shell Style/Model	XK_.XP*: Fixed socket, key (N) or keys (P, S and T),blue, with two nuts (back panel mounting)
Keying	3 key (alpha=30, plug: male contacts, receptacle: female contacts)
Housing Material	
Cable Fixing	∅0 - 0 mm
Variant	A : Blue front nut

Performance

Configuration	M08 : 8 Low Voltage
Insulator	L: PEEK
Rated Current	

Specifications

Test voltage (kV rms) Contact-contact: 1.5
Air clearance min. (mm) or Creepage distance min. (mm): 0.75

Others

F ret (average): 130 N
Working temperature: -50 deg C to + 170 deg C

DRAWINGS

Draws

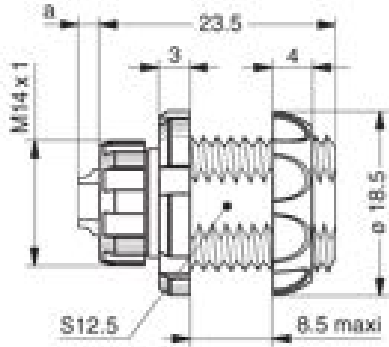

Dimensions

	A	L	N	e
mm.	18.5	25.7	23.5	M14x1
in.	0.73	1.01	0.93	

RECOMMENDED BY LEMO

Tools

None

Cables