

## Single line low capacitance Transil™ for ESD protection

### Features

- single line low capacitance Transil diode
- bidirectional ESD protection
- ESD protection > 30 kV (IEC 61000-4-2 contact discharge)
- breakdown voltage  $V_{BR} = 6.1$  V min.
- low diode capacitance (22 pF typ. at 0 V)
- low leakage current < 100 nA at 3 V
- very small PCB area 0.6 mm<sup>2</sup>
- lead-free package

### Benefits

- high ESD protection level
- high integration
- suitable for high density boards

### Complies with the following standards

- IEC 61000-4-2 level 4:
  - 15 kV (air discharge)
  - 8 kV (contact discharge)
- MIL STD 883G - Method 3015-7, class 3B:
  - Human body model

### Applications

Where transient overvoltage protection in ESD sensitive equipment is required, such as:

- computers
- printers
- communication systems
- cellular phone handsets and accessories
- video equipment



Figure 1. Functional diagram

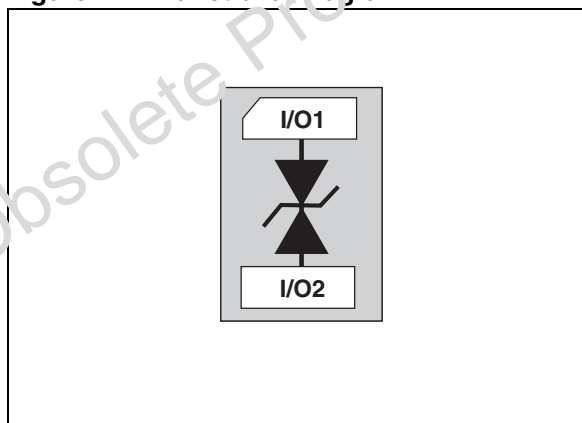

### Description

The ESDALC6V1-1BM2 is a bidirectional single line TVS diode designed to protect the data lines or other I/O ports against ESD transients.

The device is ideal for applications where both reduced line capacitance and board space saving are required.

TM: Transil is a trademark of STMicroelectronics

# 1 Characteristics

**Table 1. Absolute maximum ratings ( $T_{amb} = 25\text{ }^{\circ}\text{C}$ )**

Symbol	Parameter	Value	Unit
$V_{PP}^{(1)}$	Peak pulse voltage (IEC 61000-4-2 contact discharge)	$\pm 30$	kV
$P_{PP}^{(1)}$	Peak pulse power dissipation (8/20 $\mu\text{s}$ )	$T_j$ initial = $T_{amb}$ 140	W
$I_{PP}$	Repetitive peak pulse current (8/20 $\mu\text{s}$ )	9	A
$T_j$	Junction temperature	125	$^{\circ}\text{C}$
$T_{stg}$	Storage temperature range	- 55 to + 150	$^{\circ}\text{C}$
$T_L$	Maximum lead temperature for soldering during 10 s	260	$^{\circ}\text{C}$
$T_{OP}$	Operating temperature range	- 40 to + 125	$^{\circ}\text{C}$

1. For a surge greater than the maximum values, the diode will fail in short-circuit.

**Figure 2. Electrical characteristics (definitions)**

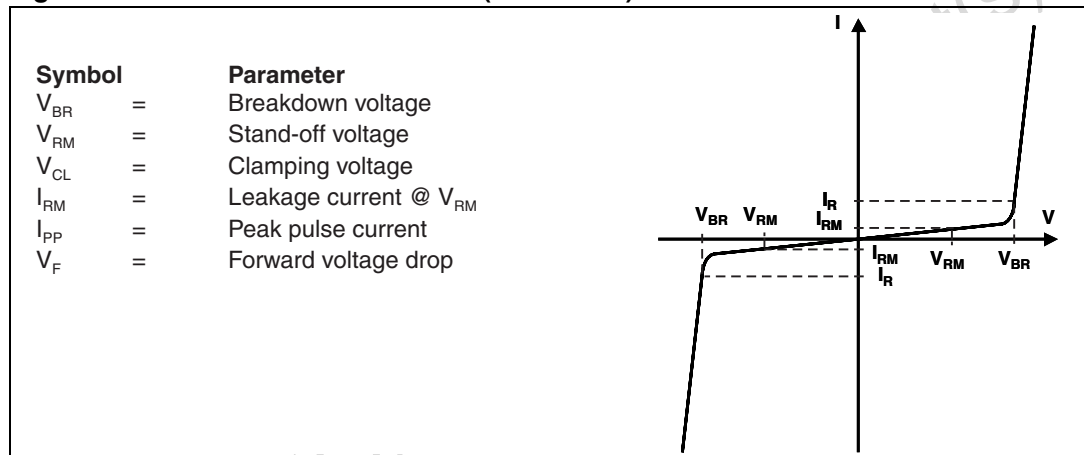

**Table 2. Electrical characteristics**

Order code	$V_{BR} @ I_R$		$I_{RM} @ V_{RM}$		$R_d$	$\alpha T$	$C @ 0\text{ V Bias}$	
	min.	max.	max.		typ.	max.	typ.	
	V	V	mA	nA	V	$\Omega$	$10^{-4}/^{\circ}\text{C}$	pF
ESDALC6V1-1BM2	6.1	8.0	1	100	3	0.65	2.5	22

**Figure 3. Relative variation of peak pulse power versus initial junction temperature**

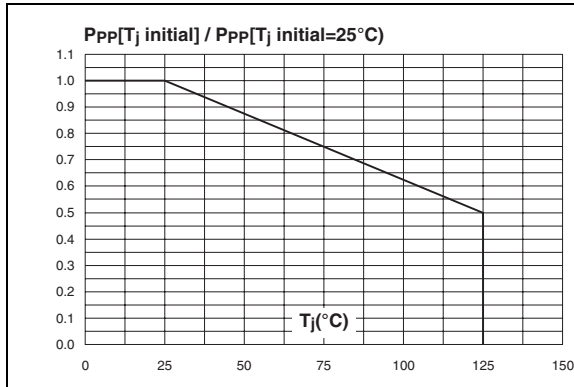

**Figure 4. Peak pulse power versus exponential pulse duration**

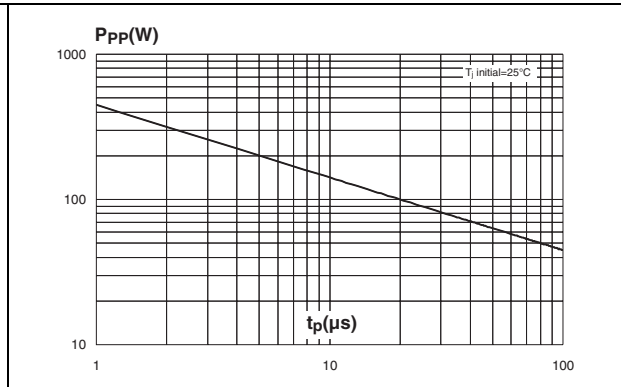

**Figure 5. Clamping voltage versus peak pulse current (typical values)**

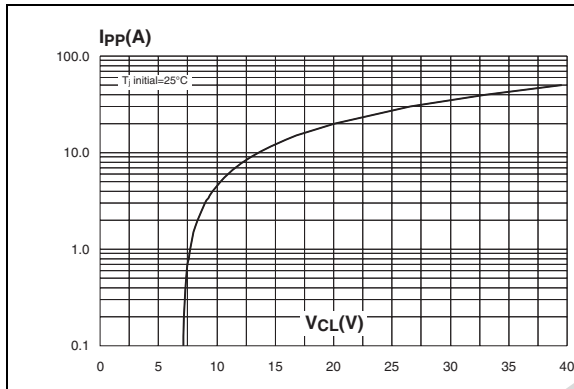

**Figure 6. Junction capacitance versus reverse voltage applied (typical values)**

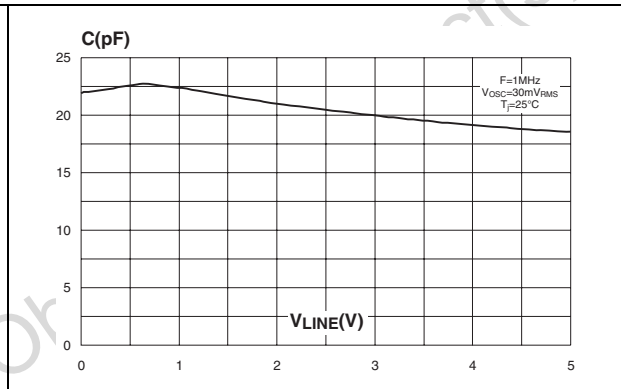

**Figure 7. Relative variation of leakage current versus junction temperature (typical values)**

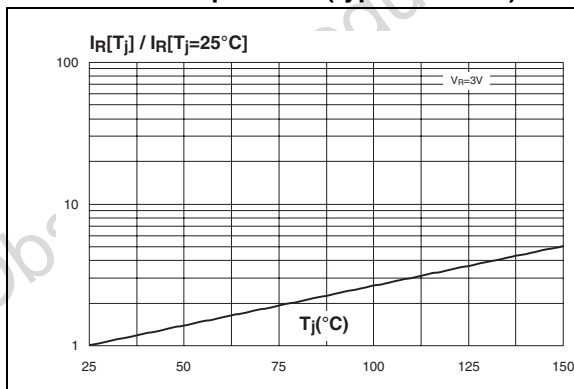

**Figure 8. ESD response to IEC 61000-4-2 (+15 kV air discharge) on each channel**

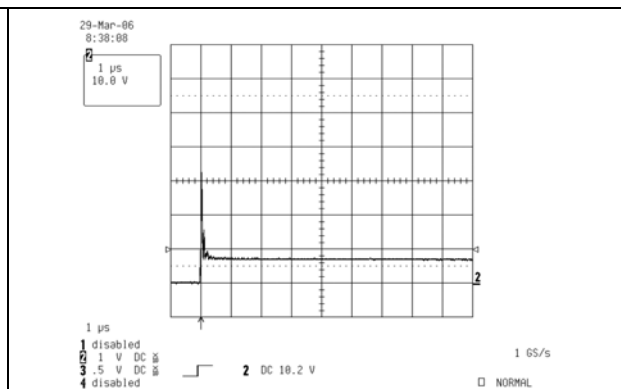

Figure 9. ESD response to IEC 61000-4-2 (-15 kV air discharge) on each channel

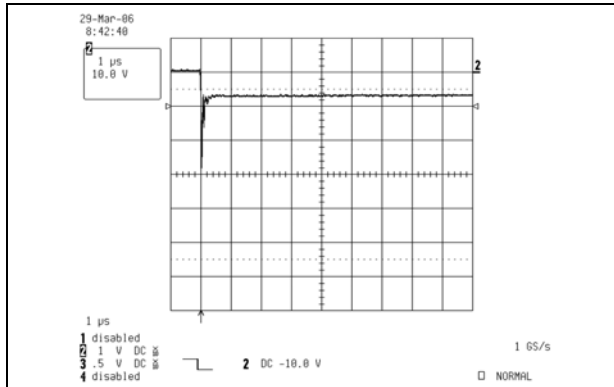
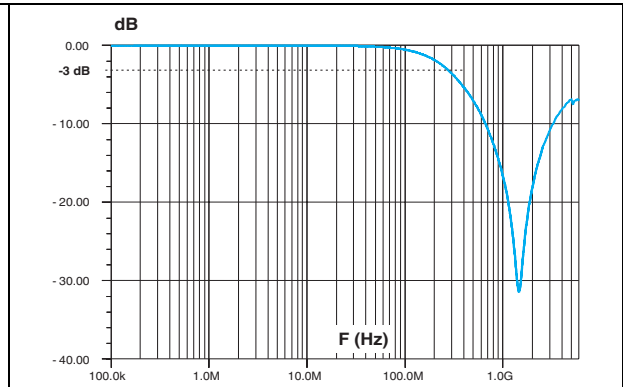
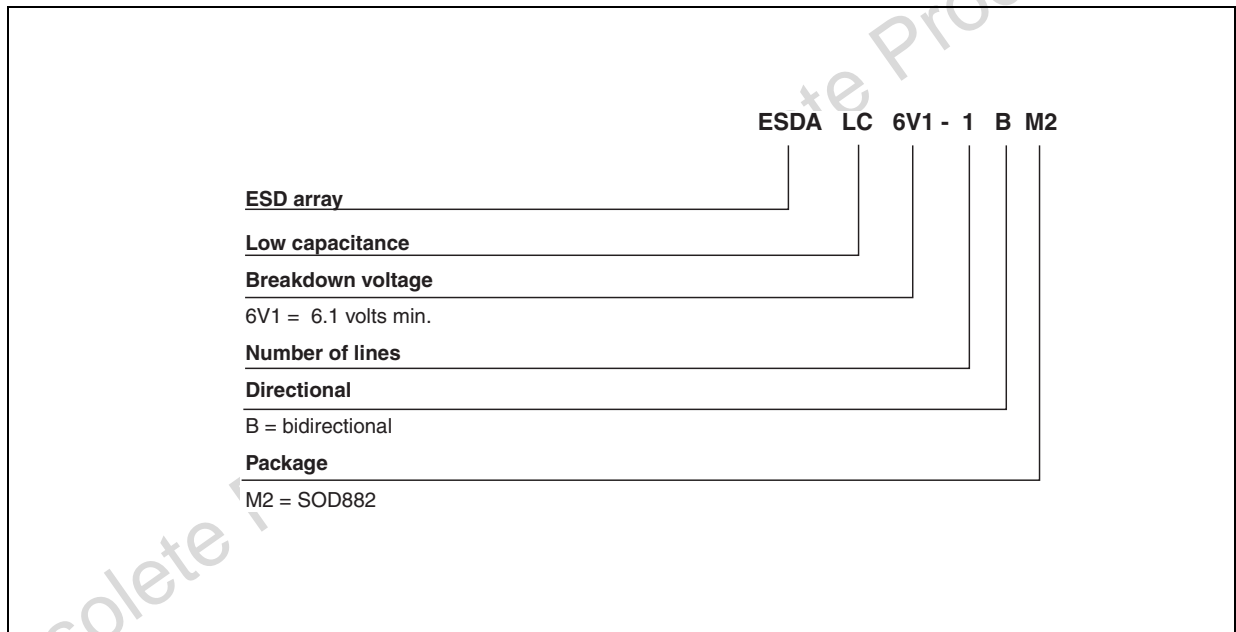

Figure 10. S21 attenuation measurement result



## 2 Ordering information scheme

Figure 11. Ordering information scheme



### 3 Package information

- Epoxy meets UL94, V0
- Lead-free package

In order to meet environmental requirements, ST offers these devices in different grades of ECOPACK® packages, depending on their level of environmental compliance. ECOPACK® specifications, grade definitions and product status are available at: [www.st.com](http://www.st.com). ECOPACK® is an ST trademark.

**Table 3. SOD882 dimensions**

Ref.	Dimensions					
	Millimeters			Inches		
	Min.	Typ.	Max.	Min.	Typ.	Max.
A	0.40	0.47	0.50	0.016	0.019	0.020
A1	0.00		0.05	0.000		0.002
b1	0.20	0.25	0.30	0.008	0.010	0.012
b2	0.20	0.25	0.30	0.008	0.010	0.012
D		1.00			0.039	
E		0.60			0.024	
e		0.65			0.026	
L1	0.45	0.50	0.55	0.018	0.020	0.022
L2	0.45	0.50	0.55	0.018	0.020	0.022

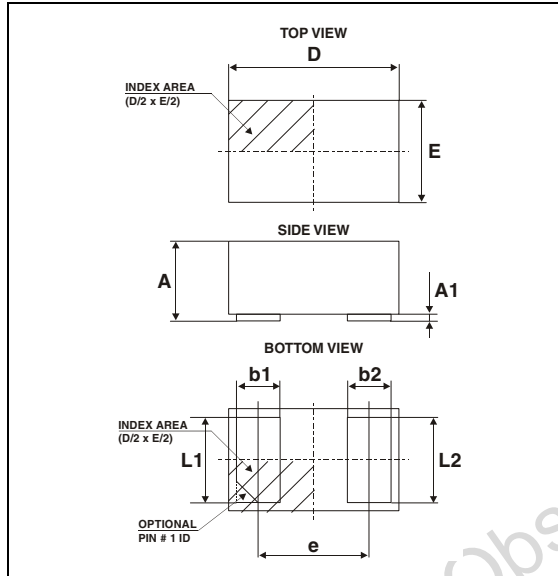

*Note: Product marking may be rotated by 90° for assembly plant differentiation. In no case should this product marking be used to orient the component for its placement on a PCB. Only pin 1 mark is to be used for this purpose.*

**Figure 12. Footprint (dimensions in mm) Figure 13. Marking**

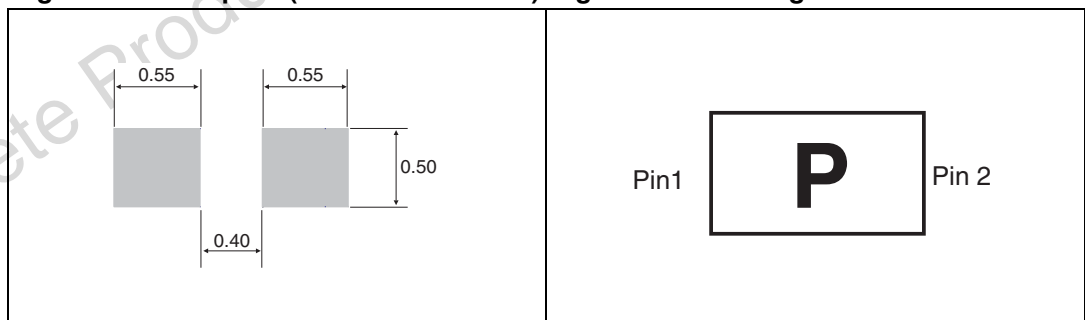
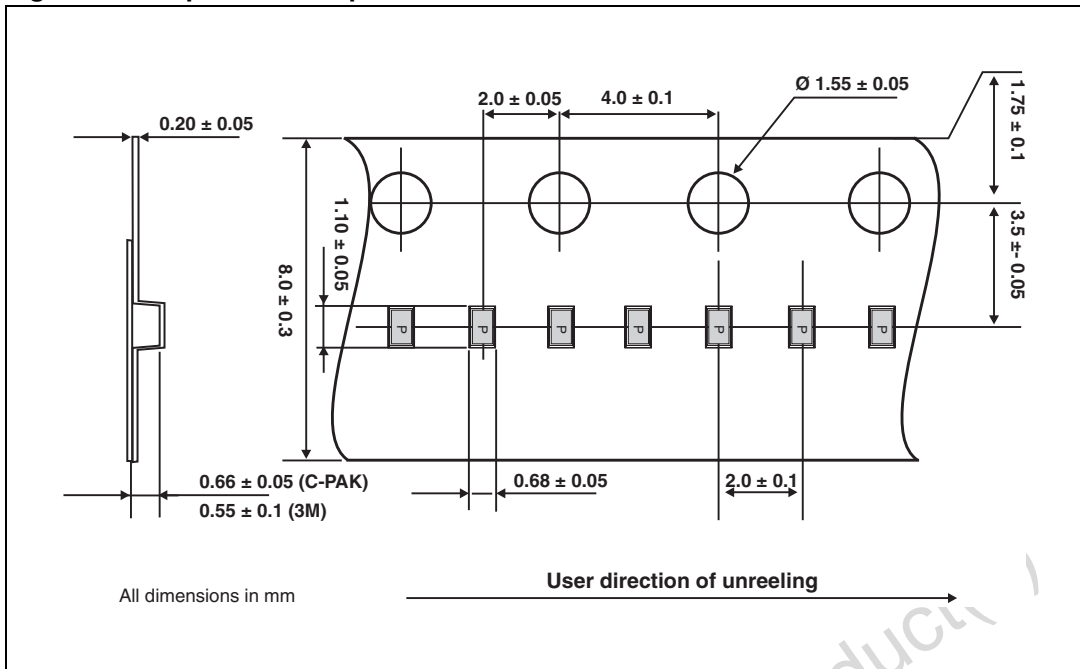

Figure 14. Tape and reel specifications



Obsolete Product(s) - Obsolete Product(s)

## 4 Recommendation on PCB assembly

### 4.1 Stencil opening design

1. General recommendation on stencil opening design
  - a) Stencil opening dimensions: L (Length), W (Width), T (Thickness).

**Figure 15. Stencil opening dimensions**

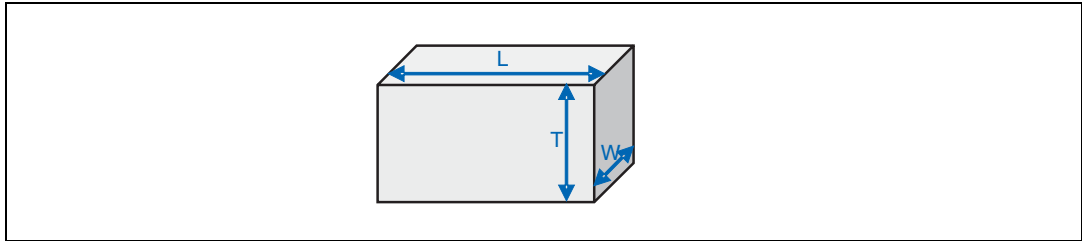

- b) General design rule
  - Stencil thickness (T) = 75 ~ 125  $\mu\text{m}$
  - Aspect Ratio =  $\frac{W}{T} \geq 1.5$
  - Aspect Area =  $\frac{L \times W}{2T(L + W)} \geq 0.66$

2. Reference design
  - a) Stencil opening thickness: 100  $\mu\text{m}$
  - b) Stencil opening for leads: Opening to footprint ratio - between 60% and 65%.

**Figure 16. Recommended stencil windows position**

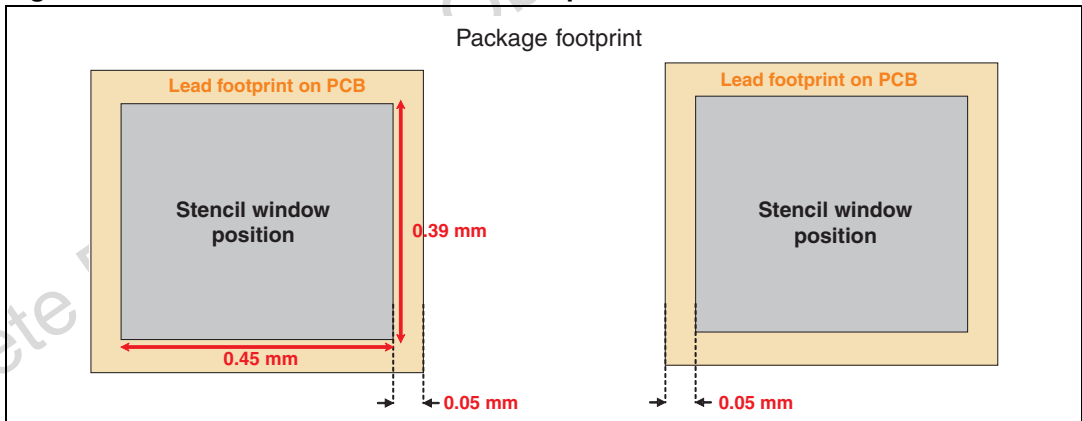

### 4.2 Solder paste

1. Halide-free flux qualification ROL0 according to ANSI/J-STD-004.
2. "No clean" solder paste is recommended.
3. Offers a high tack force to resist component movement during high speed
4. Solder paste with fine particles: powder particle size is 20-45  $\mu\text{m}$ .

### 4.3 Placement

1. Manual positioning is not recommended.
2. It is recommended to use the lead recognition capabilities of the placement system, not the outline centering
3. Standard tolerance of  $\pm 0.05$  mm is recommended.
4. 3.5 N placement force is recommended. Too much placement force can lead to squeezed out solder paste and cause solder joints to short. Too low placement force can lead to insufficient contact between package and solder paste that could cause open solder joints or badly centered packages.
5. To improve the package placement accuracy, a bottom side optical control should be performed with a high resolution tool.
6. For assembly, a perfect supporting of the PCB (all the more on flexible PCB) is recommended during solder paste printing, pick and place and reflow soldering by using optimized tools.

### 4.4 PCB design preference

1. To control the solder paste amount, the closed via is recommended instead of open vias.
2. The position of tracks and open vias in the solder area should be well balanced. The symmetrical layout is recommended, in case any tilt phenomena caused by asymmetrical solder paste amount due to the solder flow away.

### 4.5 Reflow profile

Figure 17. ST ECOPACK recommended soldering reflow profile for PCB mounting

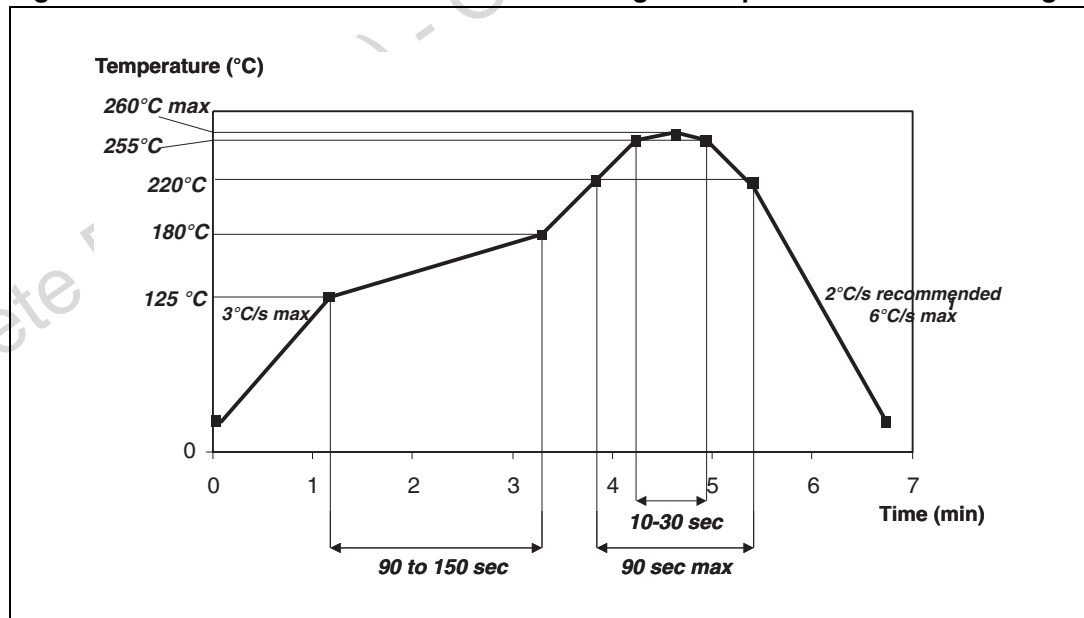

Note: Minimize air convection currents in the reflow oven to avoid component movement.



## 5 Ordering information

**Table 4. Ordering information**

Order code	Marking	Package	Weight	Base qty	Delivery mode
ESDALC6V1-1BM2	P <sup>(1)</sup>	SOD882	0.89 mg	12000	Tape and reel

1. The marking can be rotated by 90° to differentiate assembly location

## 6 Revision history

**Table 5. Document revision history**

Date	Revision	Changes
11-Jan-2007	1	Initial release.
1-Apr-2007	2	Reformatted to current standards. Added <a href="#">Figure 13.: Marking</a> . Updated <a href="#">Figure 14.: Tape and reel specifications</a> . Added <a href="#">Section 4: Recommendation on PCB assembly</a> .
02-Dec-2010	3	Updated base quantity <a href="#">Table 4</a> .

**Please Read Carefully:**

Information in this document is provided solely in connection with ST products. STMicroelectronics NV and its subsidiaries ("ST") reserve the right to make changes, corrections, modifications or improvements, to this document, and the products and services described herein at any time, without notice.

All ST products are sold pursuant to ST's terms and conditions of sale.

Purchasers are solely responsible for the choice, selection and use of the ST products and services described herein, and ST assumes no liability whatsoever relating to the choice, selection or use of the ST products and services described herein.

No license, express or implied, by estoppel or otherwise, to any intellectual property rights is granted under this document. If any part of this document refers to any third party products or services it shall not be deemed a license grant by ST for the use of such third party products or services, or any intellectual property contained therein or considered as a warranty covering the use in any manner whatsoever of such third party products or services or any intellectual property contained therein.

**UNLESS OTHERWISE SET FORTH IN ST'S TERMS AND CONDITIONS OF SALE ST DISCLAIMS ANY EXPRESS OR IMPLIED WARRANTY WITH RESPECT TO THE USE AND/OR SALE OF ST PRODUCTS INCLUDING WITHOUT LIMITATION IMPLIED WARRANTIES OF MERCHANTABILITY, FITNESS FOR A PARTICULAR PURPOSE (AND THEIR EQUIVALENTS UNDER THE LAWS OF ANY JURISDICTION), OR INFRINGEMENT OF ANY PATENT, COPYRIGHT OR OTHER INTELLECTUAL PROPERTY RIGHT.**

**UNLESS EXPRESSLY APPROVED IN WRITING BY AN AUTHORIZED ST REPRESENTATIVE, ST PRODUCTS ARE NOT RECOMMENDED, AUTHORIZED OR WARRANTED FOR USE IN MILITARY, AIR CRAFT, SPACE, LIFE SAVING, OR LIFE SUSTAINING APPLICATIONS, NOR IN PRODUCTS OR SYSTEMS WHERE FAILURE OR MALFUNCTION MAY RESULT IN PERSONAL INJURY, DEATH, OR SEVERE PROPERTY OR ENVIRONMENTAL DAMAGE. ST PRODUCTS WHICH ARE NOT SPECIFIED AS "AUTOMOTIVE GRADE" MAY ONLY BE USED IN AUTOMOTIVE APPLICATIONS AT USER'S OWN RISK.**

Resale of ST products with provisions different from the statements and/or technical features set forth in this document shall immediately void any warranty granted by ST for the ST product or service described herein and shall not create or extend in any manner whatsoever, any liability of ST.

ST and the ST logo are trademarks or registered trademarks of ST in various countries.

Information in this document supersedes and replaces all information previously supplied.

The ST logo is a registered trademark of STMicroelectronics. All other names are the property of their respective owners.

© 2010 STMicroelectronics - All rights reserved

STMicroelectronics group of companies

Australia - Belgium - Brazil - Canada - China - Czech Republic - Finland - France - Germany - Hong Kong - India - Israel - Italy - Japan - Malaysia - Malta - Morocco - Philippines - Singapore - Spain - Sweden - Switzerland - United Kingdom - United States of America

[www.st.com](http://www.st.com)