

2nd Generation thinQ!TM SiC Schottky Diode

Features

- Revolutionary semiconductor material - Silicon Carbide
- Switching behavior benchmark
- No reverse recovery/ No forward recovery
- No temperature influence on the switching behavior
- High surge current capability
- Pb-free lead plating; RoHS compliant
- Qualified according to JEDEC¹⁾ for target applications
- Breakdown voltage tested at 5mA²⁾

Product Summary

V_{DC}	600	V
Q_c	12	nC
I_F	5	A

PG-TO220-2

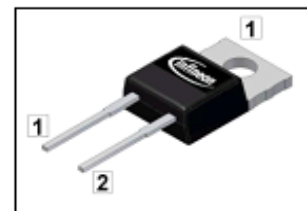

thinQ! 2G Diode specially designed for fast switching applications like:

- CCM PFC
- Motor Drives

Type	Package	Marking	Pin 1	Pin 2
IDH05S60C	PG-TO220-2	D05S60C	C	A

Maximum ratings, at $T_j=25\text{ °C}$, unless otherwise specified

Parameter	Symbol	Conditions	Value	Unit
Continuous forward current	I_F	$T_C < 140\text{ °C}$	5	A
RMS forward current	$I_{F,RMS}$	$f=50\text{ Hz}$	7.5	
Surge non-repetitive forward current, sine halfwave	$I_{F,SM}$	$T_C=25\text{ °C}$, $t_p=10\text{ ms}$	42	
Repetitive peak forward current	$I_{F,RM}$	$T_j=150\text{ °C}$, $T_C=100\text{ °C}$, $D=0.1$	21	
Non-repetitive peak forward current	$I_{F,max}$	$T_C=25\text{ °C}$, $t_p=10\text{ }\mu\text{s}$	180	
i^2t value	$\int i^2 dt$	$T_C=25\text{ °C}$, $t_p=10\text{ ms}$	9	A ² s
Repetitive peak reverse voltage	V_{RRM}		600	V
Diode dv/dt ruggedness	dv/dt	$V_R = 0 \dots 480\text{V}$	50	V/ns
Power dissipation	P_{tot}	$T_C=25\text{ °C}$	55	W
Operating and storage temperature	T_j , T_{stg}		-55 ... 175	°C
Mounting torque		M3 and M3.5 screws	60	Mcm
Soldering temperature, wavesoldering only allowed at leads	T_{sold}	1.6mm (0.063 in.) from case for 10s	260	°C

Parameter	Symbol	Conditions	Values			Unit
			min.	typ.	max.	

Thermal characteristics

Thermal resistance, junction - case	R_{thJC}		-	-	2.7	K/W
Thermal resistance, junction - ambient	R_{thJA}	leaded	-	-	62	

Electrical characteristics, at $T_j=25\text{ }^\circ\text{C}$, unless otherwise specified
Static characteristics

DC blocking voltage	V_{DC}	$I_R=0.07\text{ mA}$	600	-	-	V
Diode forward voltage	V_F	$I_F=5\text{ A}, T_j=25\text{ }^\circ\text{C}$	-	1.5	1.7	
		$I_F=5\text{ A}, T_j=150\text{ }^\circ\text{C}$	-	1.7	2.1	
Reverse current	I_R	$V_R=600\text{ V}, T_j=25\text{ }^\circ\text{C}$	-	0.6	70	μA
		$V_R=600\text{ V}, T_j=150\text{ }^\circ\text{C}$	-	2.5	700	

AC characteristics

Total capacitive charge	Q_c	$V_R=400\text{ V}, I_F \leq I_{F,max},$ $di_F/dt=200\text{ A}/\mu\text{s},$ $T_j=150\text{ }^\circ\text{C}$	-	12	-	nC
Switching time ³⁾	t_c		-	-	<10	ns
	C	$V_R=1\text{ V}, f=1\text{ MHz}$	-	240	-	μF
		$V_R=300\text{ V}, f=1\text{ MHz}$	-	30	-	
		$V_R=600\text{ V}, f=1\text{ MHz}$	-	30	-	

¹⁾ J-STD20 and JESD22

²⁾ All devices tested under avalanche conditions, for a time periode of 5ms, at 5mA.

³⁾ t_c is the time constant for the capacitive displacement current waveform (independent from T_j , I_{LOAD} and di/dt), different from t_{rr} , which is dependent on T_j , I_{LOAD} , di/dt . No reverse recovery time constant t_{rr} due to absence of minority carrier injection.

⁴⁾ Only capacitive charge occuring, guaranteed by design.

1 Power dissipation

$P_{tot}=f(T_C)$

parameter: $R_{thJC(max)}$

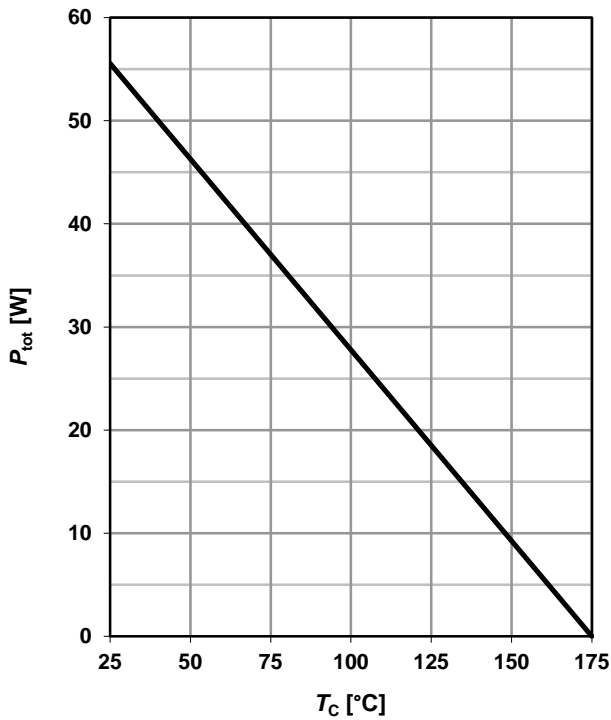

2 Diode forward current

$I_F=f(T_C); T_j \leq 175 \text{ °C}$

parameter: $R_{thJC(max)}$; $V_{F(max)}$

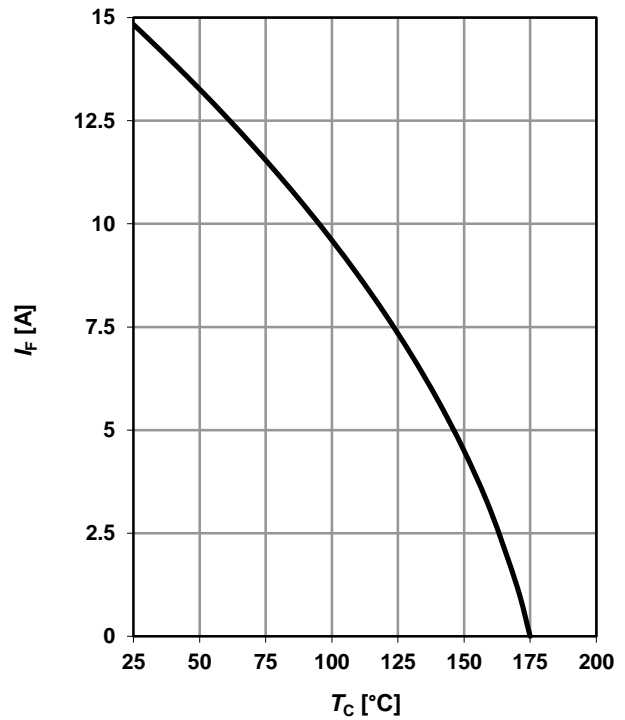

3 Typ. forward characteristic

$I_F=f(V_F); t_p=400 \text{ }\mu\text{s}$

parameter: T_j

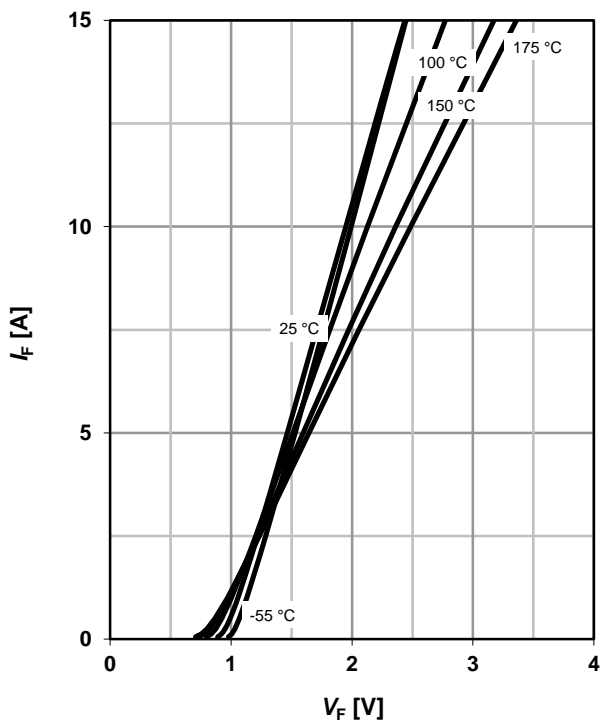

4 Typ. forward characteristic in surge current mode

$I_F=f(V_F); t_p=400 \text{ }\mu\text{s}$; parameter: T_j

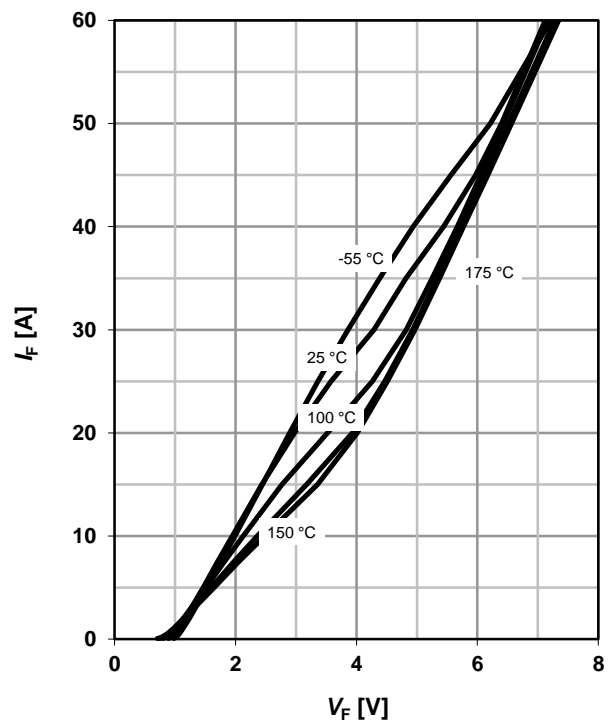

5 Typ. forward power dissipation vs. average forward current

$P_{F(AV)} = f(I_F)$, $T_C = 100\text{ °C}$, parameter: $D = t_p/T$

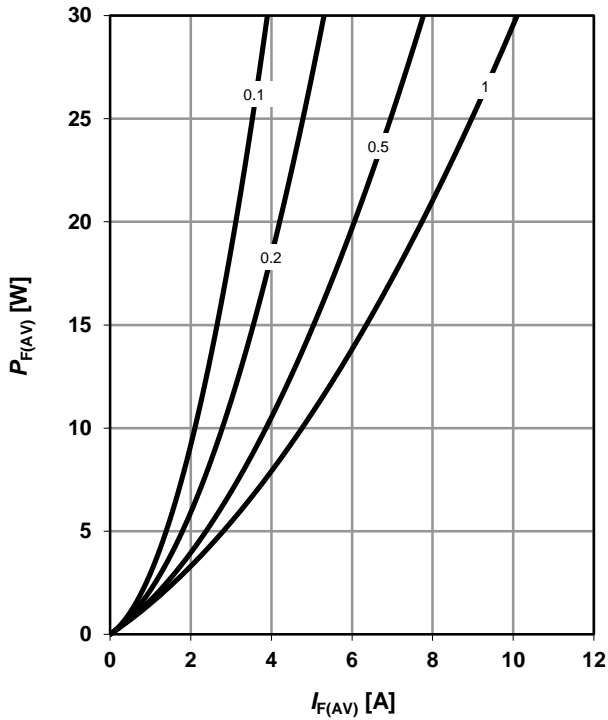

6 Typ. reverse current vs. reverse voltage

$I_R = f(V_R)$

parameter: T_j

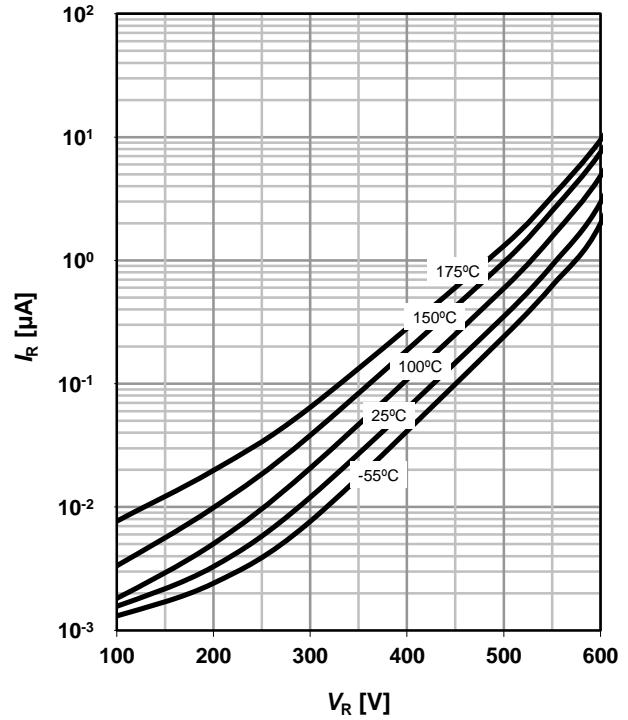

7 Transient thermal impedance

$Z_{thJC} = f(t_p)$

parameter: $D = t_p/T$

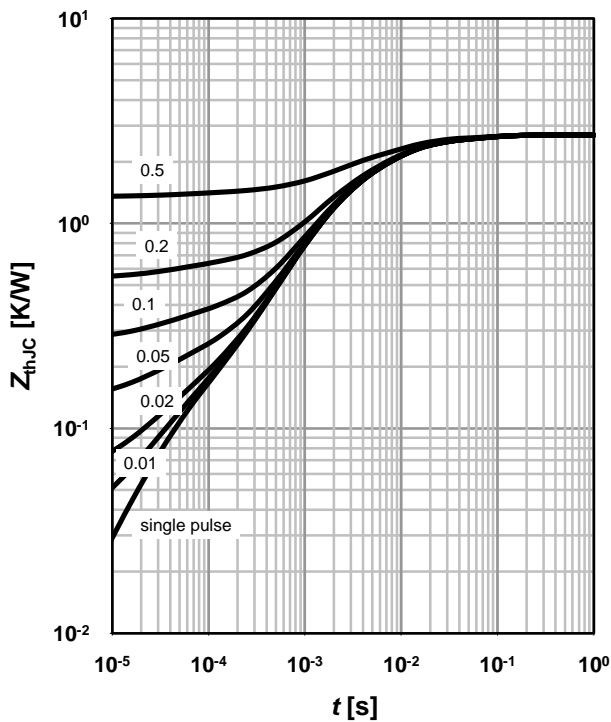

8 Typ. capacitance vs. reverse voltage

$C = f(V_R)$; $T_C = 25\text{ °C}$, $f = 1\text{ MHz}$

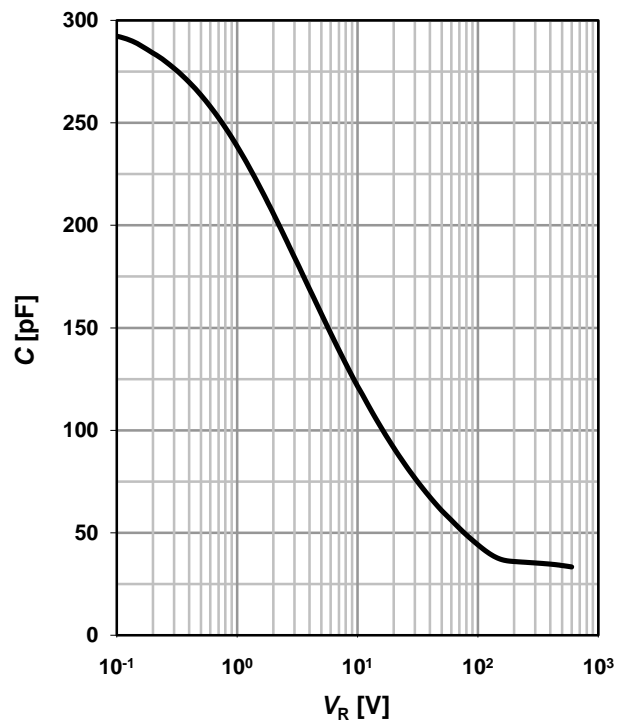

9 Typ. C stored energy

$$E_C = f(V_R)$$

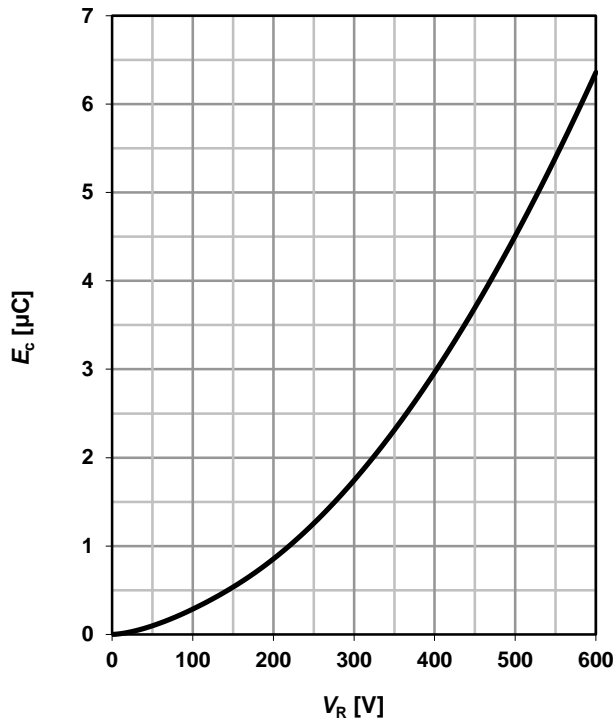

10 Typ. capacitance charge vs. current slope

$$Q_C = f(di_F/dt)^4; T_j = 150 \text{ }^\circ\text{C}; I_F \leq I_{F,max}$$

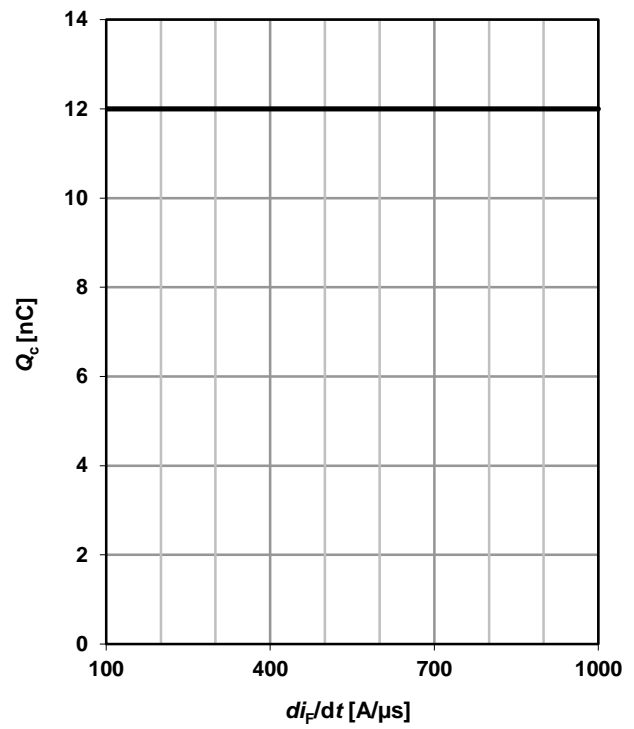

PG-T0220-2: Outline

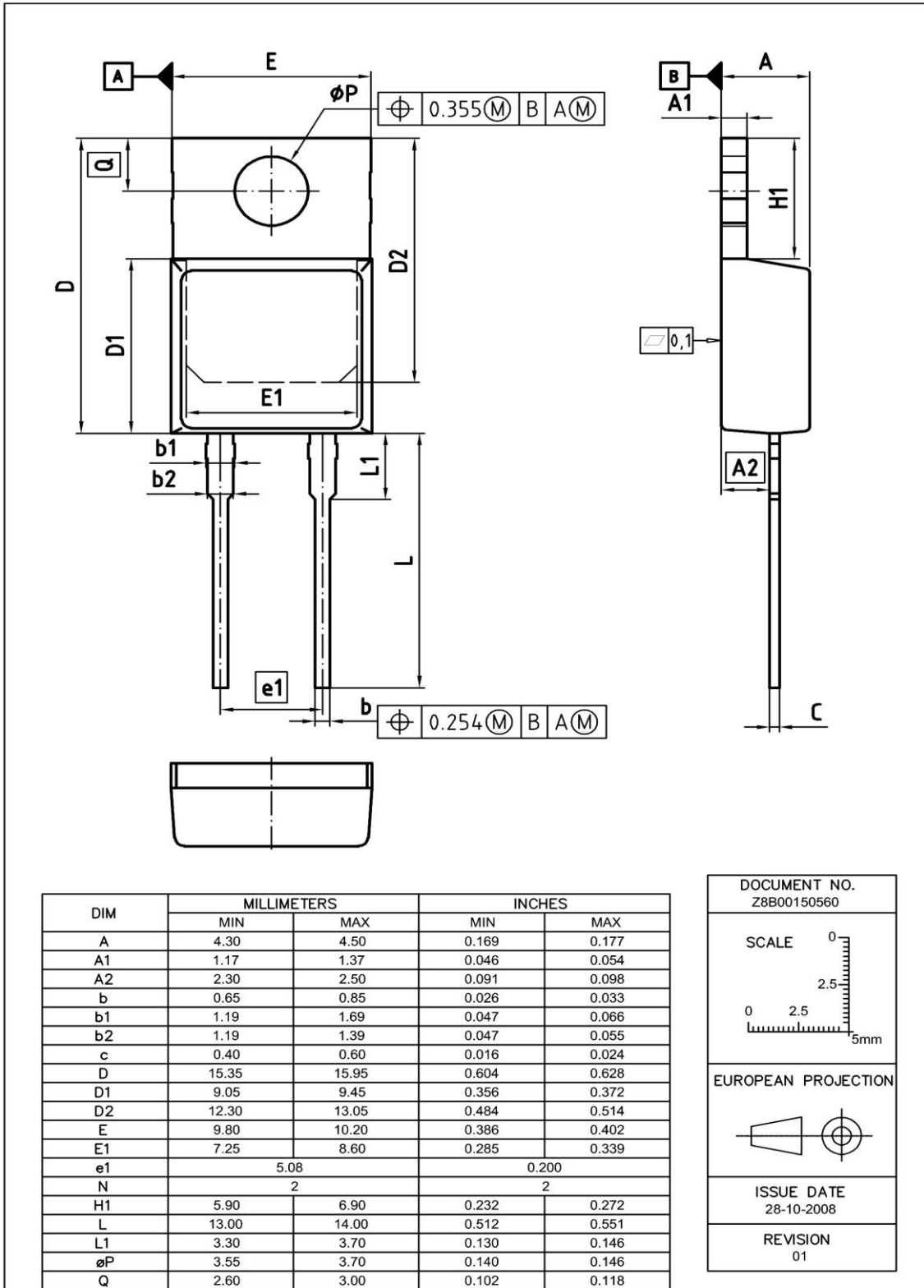

Dimensions in mm/inches

Published by
Infineon Technologies AG
81726 Munich, Germany
© 2012 Infineon Technologies AG
All Rights Reserved.

Legal Disclaimer

The information given in this document shall in no event be regarded as a guarantee of conditions or characteristics. With respect to any examples or hints given herein, any typical values stated herein and/or any information regarding the application of the device, Infineon Technologies hereby disclaims any and all warranties and liabilities of any kind, including without limitation, warranties of non-infringement of intellectual property rights of any third party.

Information

For further information on technology, delivery terms and conditions and prices, please [contact the nearest Infineon Technologies Office \(www.infineon.com\)](http://www.infineon.com).

Warnings

Due to technical requirements, components may contain dangerous substances. For information on the types in question, please contact the nearest Infineon Technologies Office. Infineon Technologies components may be used in life-support devices or systems and/or automotive, aviation and aerospace applications or systems only with

the express written approval of Infineon Technologies, if a failure of such components can reasonably be expected to cause the failure of that life-support , automotive, aviation and aerospace device or system or to affect the safety or effectiveness of that device or system. Life support systems are intended to be implanted in the human body and/or maintain and sustain and/or protect human life. If they fail, it is reasonable to assume that the health of the user or other persons may be endangered.