

AN11222

BGA3018 - 1 GHz 18 dB gain wideband amplifier MMIC

Rev. 2 — 8 January 2013

Application note

Document information

Info	Content
Keywords	BGA3018, Evaluation board, CATV, Drop amplifier
Abstract	This application note describes the schematic and layout requirements for using the BGA3018 as a CATV drop amplifier.



Revision history

Rev	Date	Description
1	20121012	First publication
2	20130108	Updated with improved application circuit and test data

Contact information

For more information, please visit: <http://www.nxp.com>

For sales office addresses, please send an email to: salesaddresses@nxp.com

1. Introduction

The BGA3018 customer evaluation board enables the user to evaluate the performance of the wideband CATV MMIC amplifier BGA3018.

The BGA3018 performance information is available in the BGA3018 datasheet.

This application note describes the evaluation board schematic and layout requirements for using the BGA3018 as a CATV drop amplifier between 40 MHz and 1003 MHz. The BGA3018 is fabricated in the BiCMOS process and packaged in a lead-free 3-pin SOT89 package. The BGA3018 is surface-mounted on an evaluation board with element matching and DC decoupling circuitry. The amplifier MMIC comprises a two stage amplifier with internal bias network and operates over a frequency range of 5 MHz to 1003 MHz with a supply voltage between 5 V and 8 V.

2. System features

- 18 dB gain
- Internally biased
- Flat gain between 40 MHz and 1003 MHz
- Noise figure of 2.2 dB
- High linearity with an $IP3_o$ of 40 dBm and $IP2_o$ of 60 dBm
- 75 Ω input and output impedance
- Unconditionally stable
- Excellent input and output return loss

3. Customer evaluation kit contents

The evaluation kit contains the following items:

- ESD safe casing
- BGA3018 evaluation board
- BGA3018 SOT89 samples

4. Application Information

For evaluation purposes an evaluation board is available. The evaluation circuit can be seen in figure 1 and the corresponding PCB is shown in figure 2. Table 1 shows the bill of materials.

4.1 Evaluation board circuit

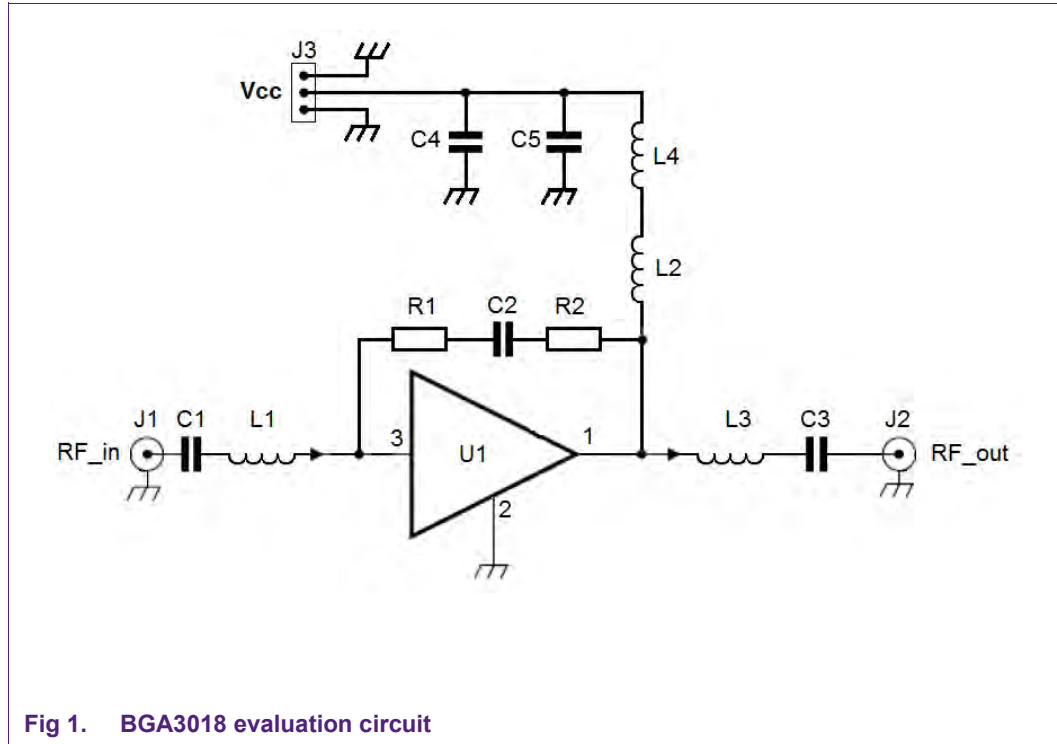
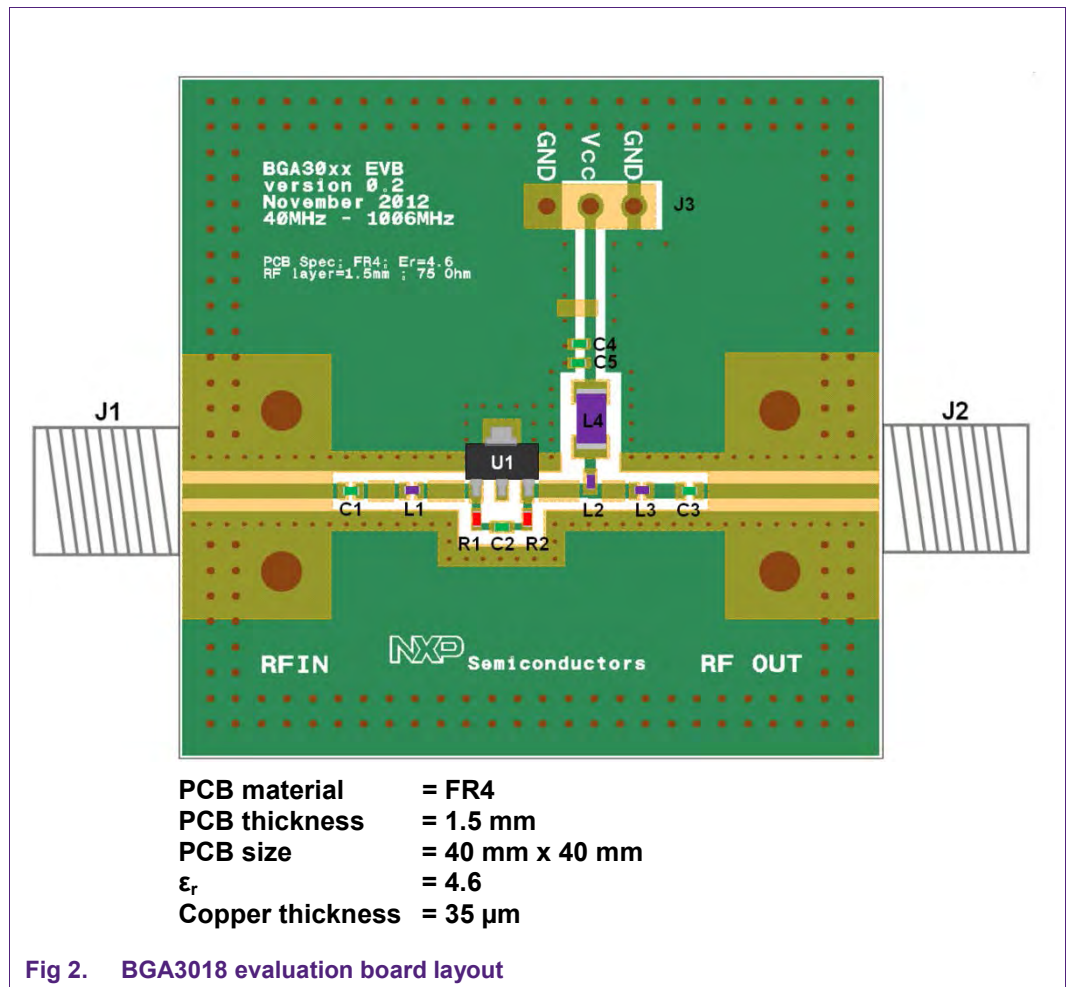

Fig 1. BGA3018 evaluation circuit

The power supply is applied on the center pin of connector J3 and is applied to the MMIC via chokes L4 and L2 which provides RF blocking to the supply line. Choke L4 is put in series with choke L2 to improve the performance at frequencies below 100 MHz. Capacitors C4 and C5 are supply decoupling capacitors.

At the F-connector J1 the RF input signal is applied where capacitor C1 provides DC-blocking, followed by L1 for input matching ($Z = 75 \Omega$). Resistors R1 and R2 are used as feedback resistors to set the gain and slope. Two resistors are used to lower the influence of the parasitic capacitance from the circuit board. Capacitor C2 provides DC-blocking between the input and output of the MMIC. Inductor L3 provides the output matching ($Z = 75 \Omega$) at the MMICs output followed by C3 for DC-blocking before the RF signal is available at F-connector J2.

4.2 Evaluation board layout



For optimum distortion performance it is important to have enough ground vias underneath and around the MMICs ground pins. This lowers the inductance to the ground plane. The evaluation board is made with two layer FR4 material.

4.3 Bill of materials

Table 1. Evaluation board BOM

Circuit Reference	Description	Qty	Mfr	Manufacturer number	Supplier	Supplier part number
U1	BGA3018	1	NXP	BGA3018	NXP	BGA3018
C1, C2, C3, C4	10 nF	4	Murata	GRM155R71E103KA01D	Digikey	490-1312-1-ND
C5	100 pF	1	Murata	GRM1555C1H101JZ01D	Digikey	490-3458-1-ND
L1, L3	3.9 nH	2	Murata	LQG15HS3N9S02D	Digikey	490-2617-1-ND
L2	Choke	1	Murata	BLM15HD182SN1D	Digikey	490-5196-1-ND
L4	880nH	1	Murata	LQH31HNR88K03L	Digikey	LQH31HNR88K03L-ND
R1	470 Ω	1	Yageo	RC0402FR-07470RL	Digikey	311-470LRCT-ND
R2	300 Ω	1	Yageo	RC0402FR-07300RL	Digikey	311-300LRCT-ND
J1, J2	75 Ω F-connector	2	Bomar	861V509ER6	Mouser	678-861V509ER6
J3	Header 3	1	Molex	90121-0763	Digikey	WM8109-ND

5. Measurement results at Vcc = 8 V

5.1 S-Parameters

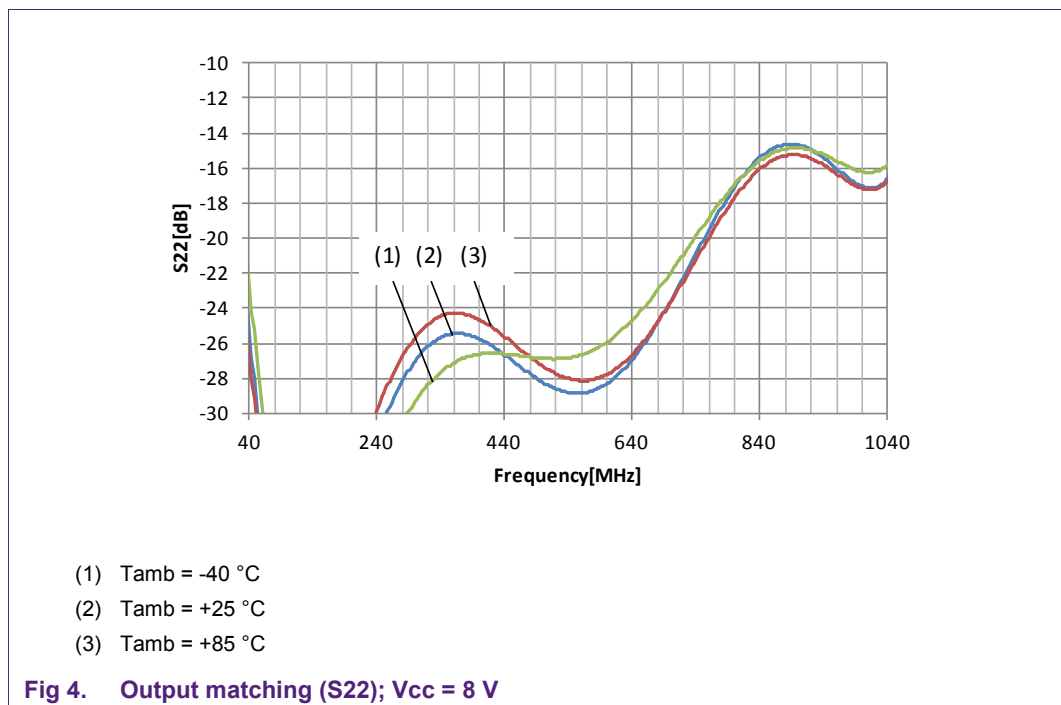
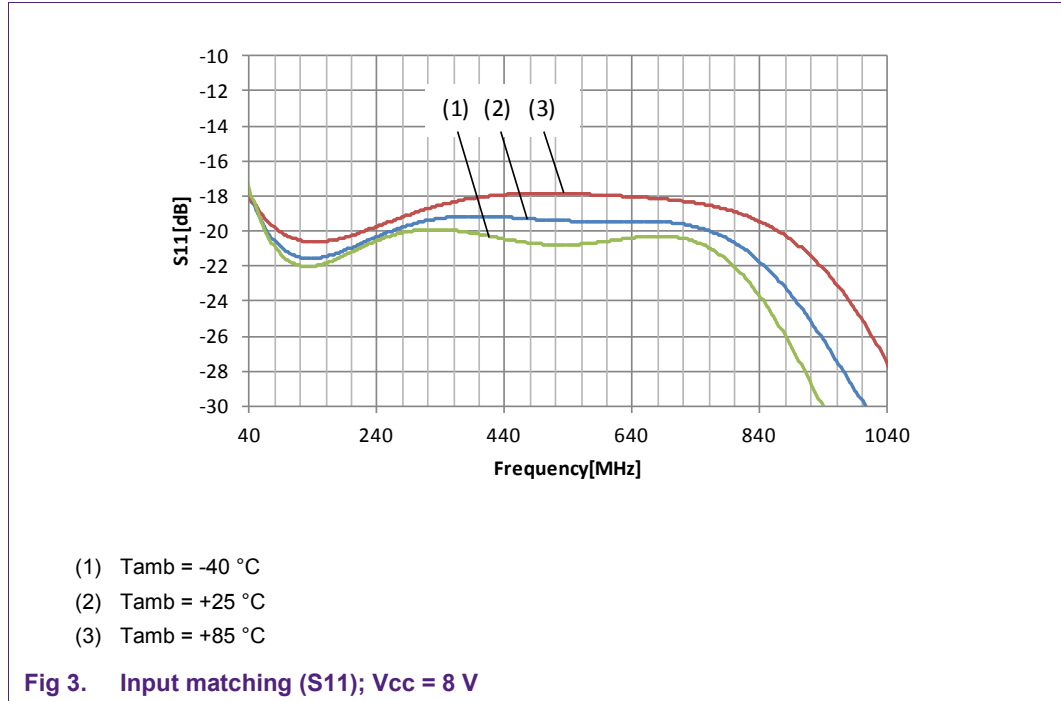

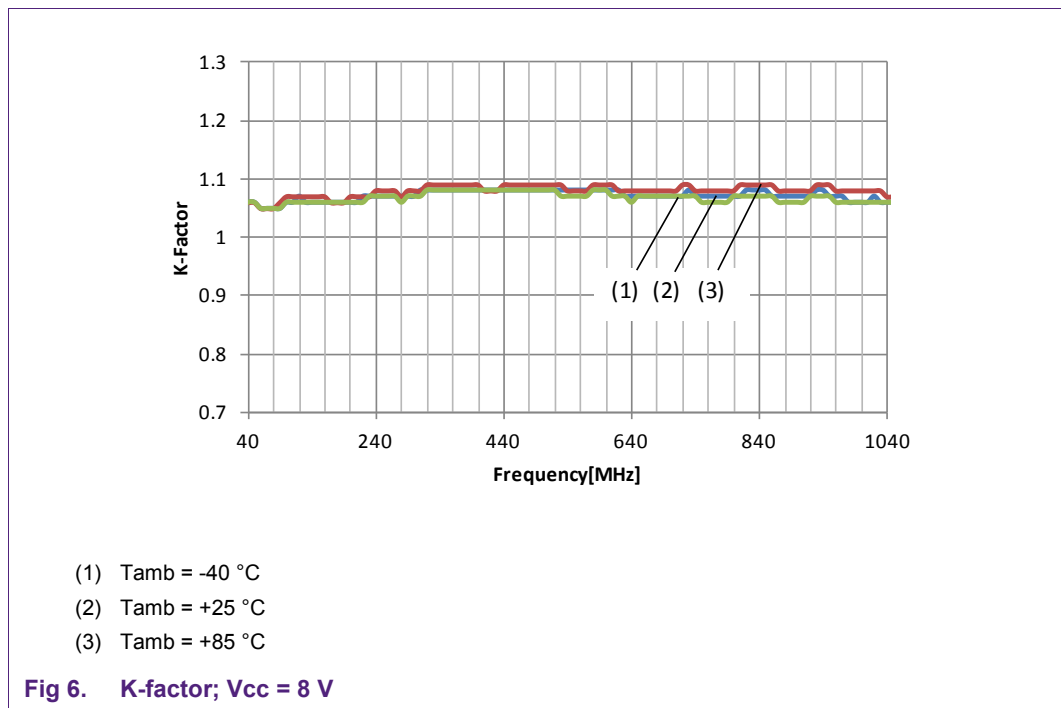
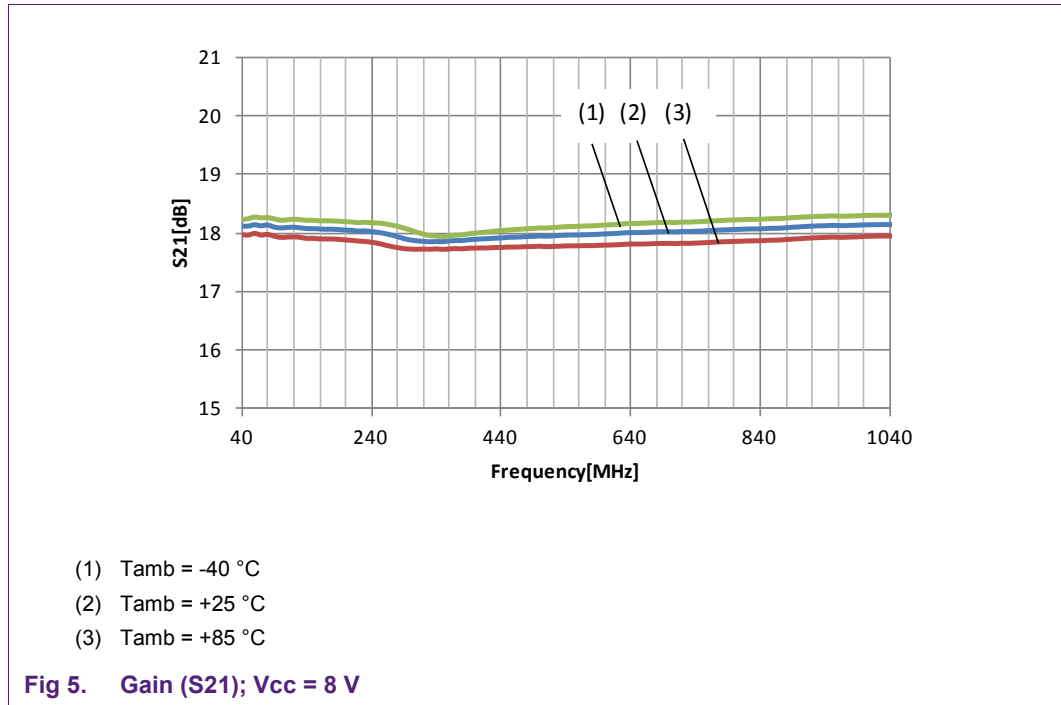

5.2 Distortion

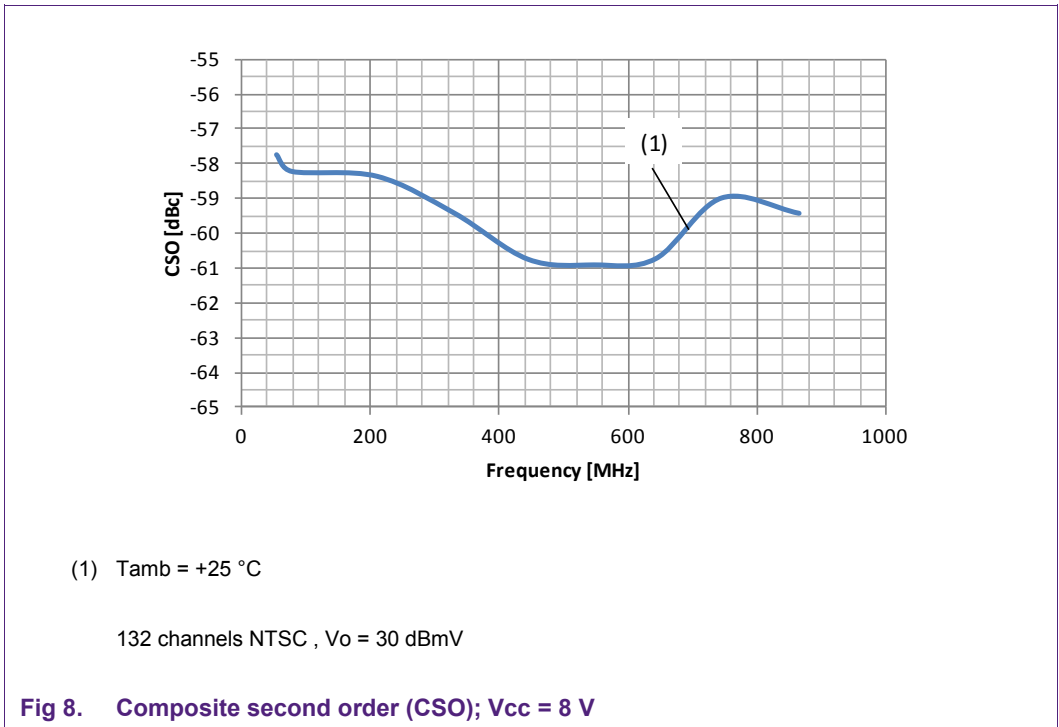
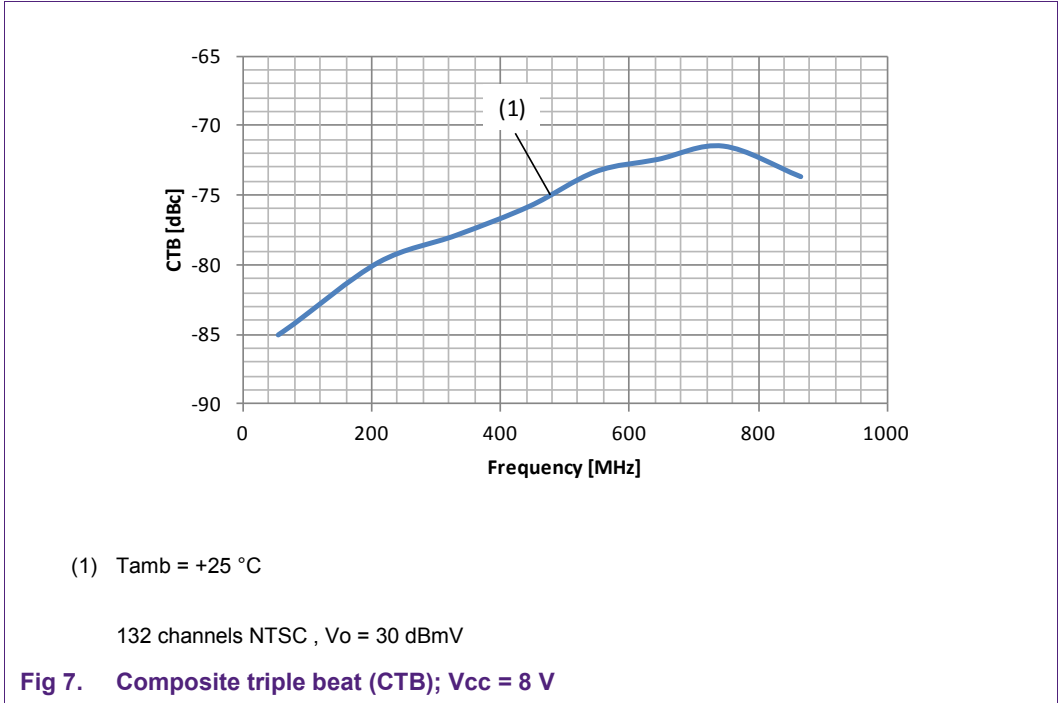

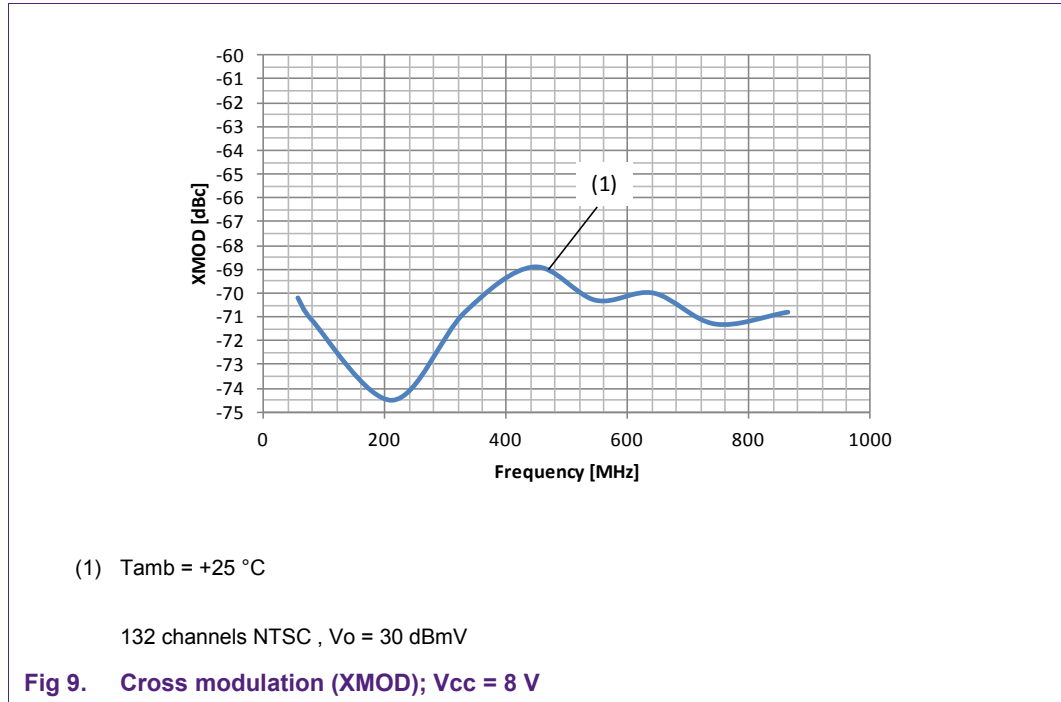

5.3 Noise figure

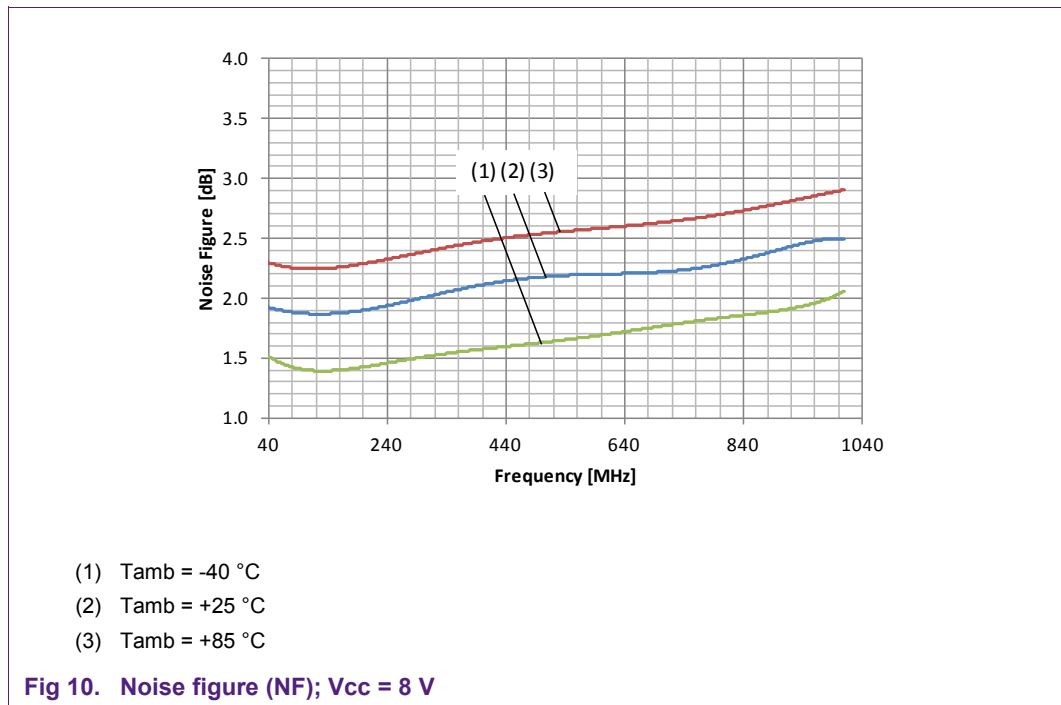

5.4 Output P1dB

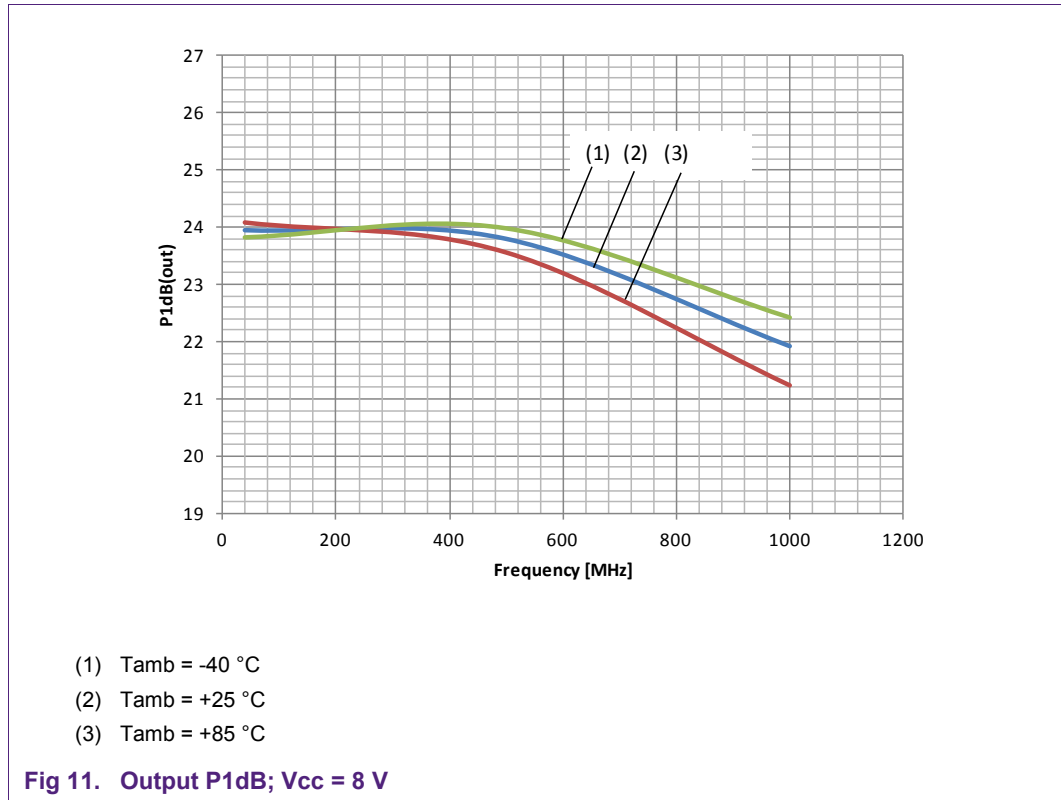

5.5 Output IP2

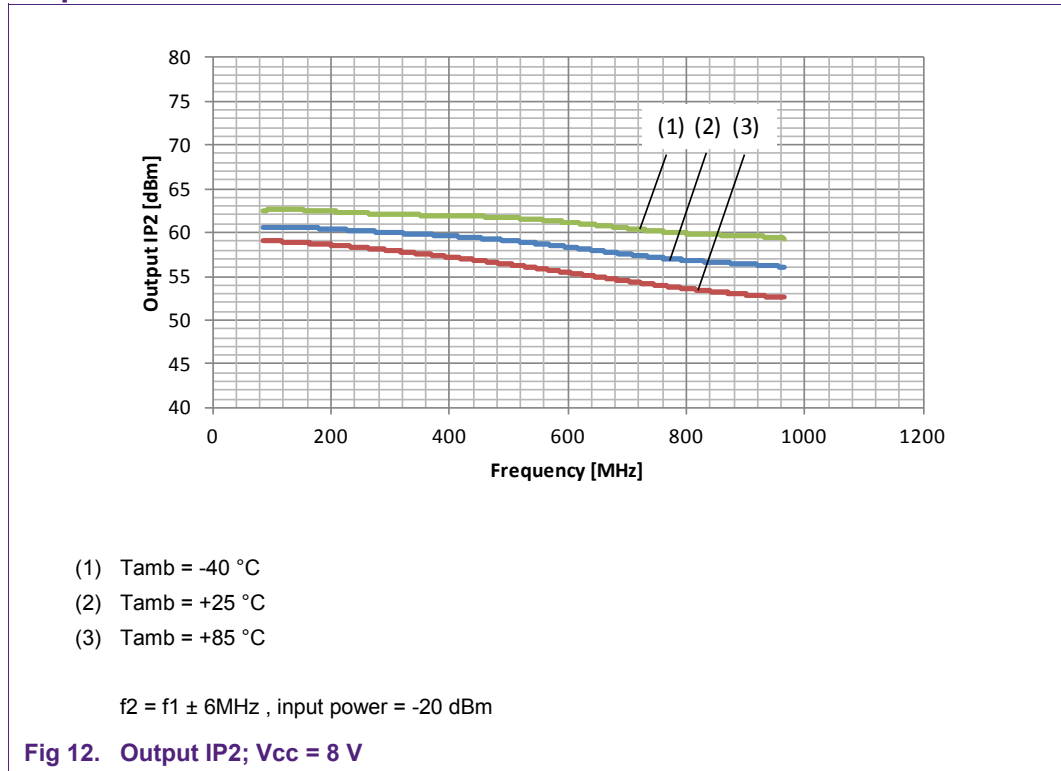

5.6 Output IP3

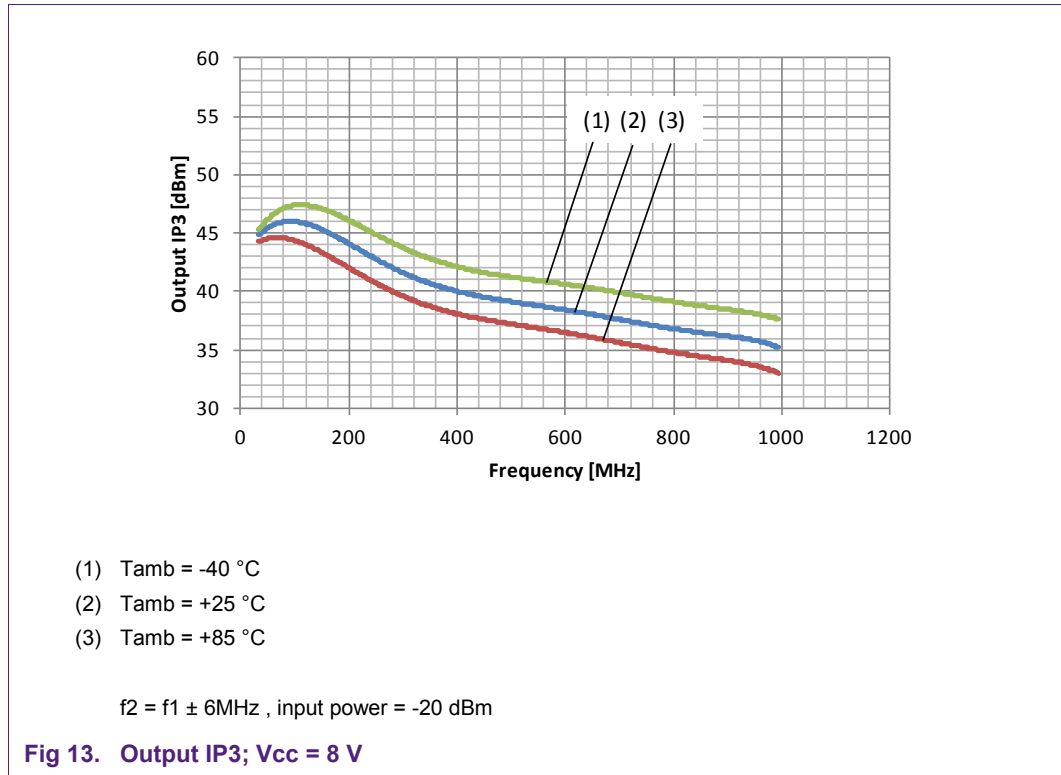

6. Measurement results at Vcc = 5 V

6.1 S-Parameters

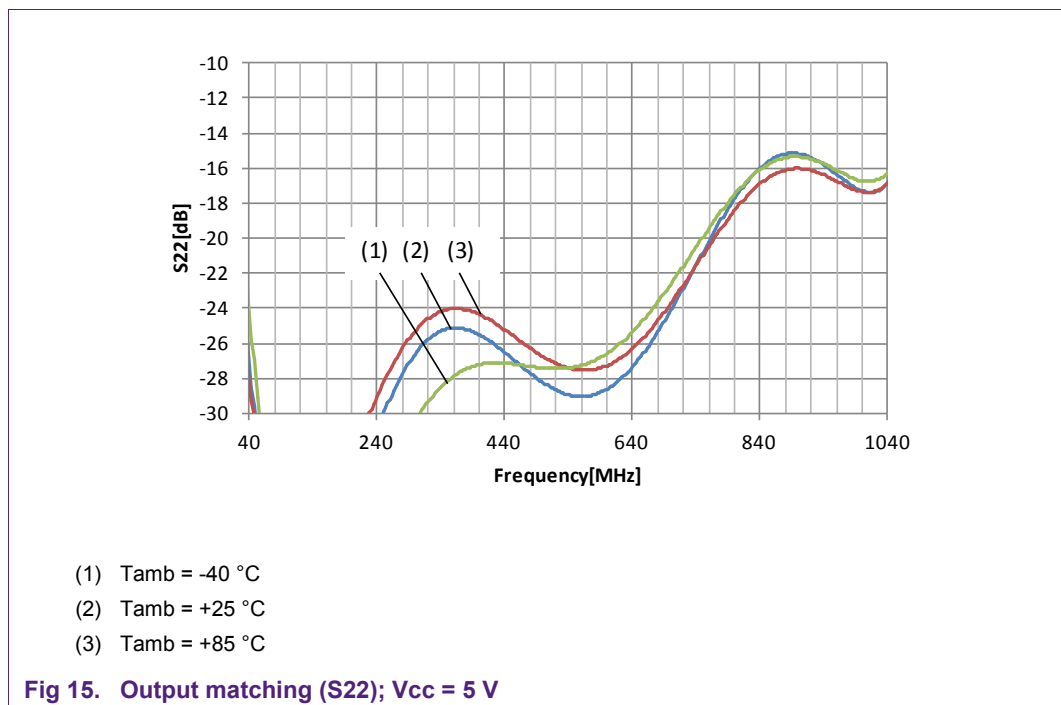
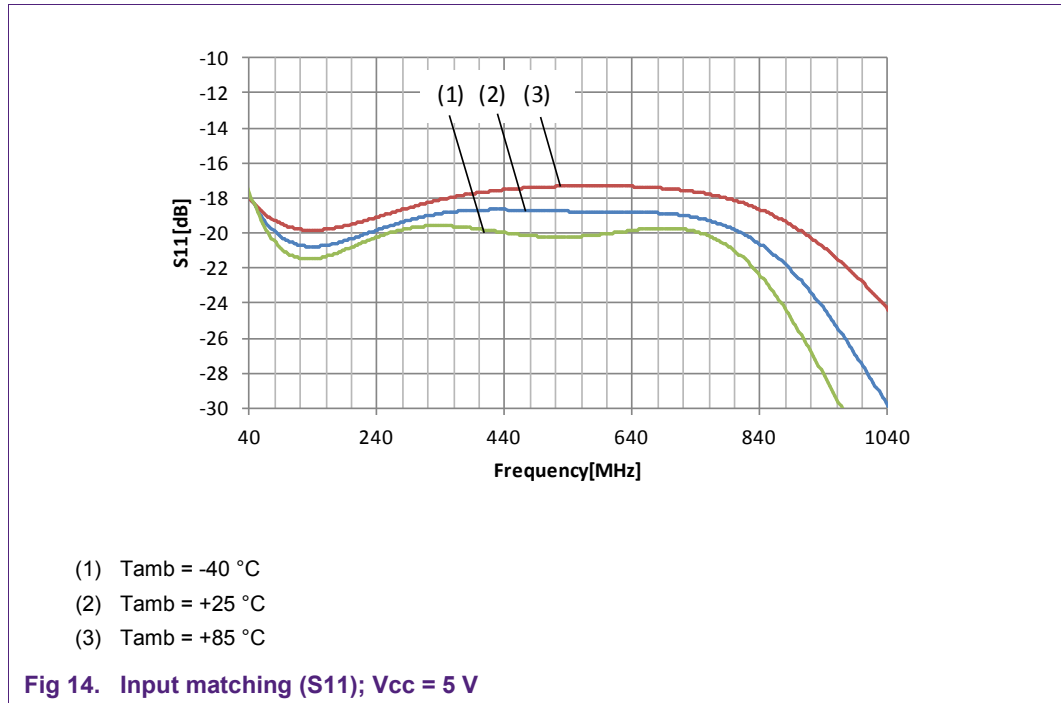

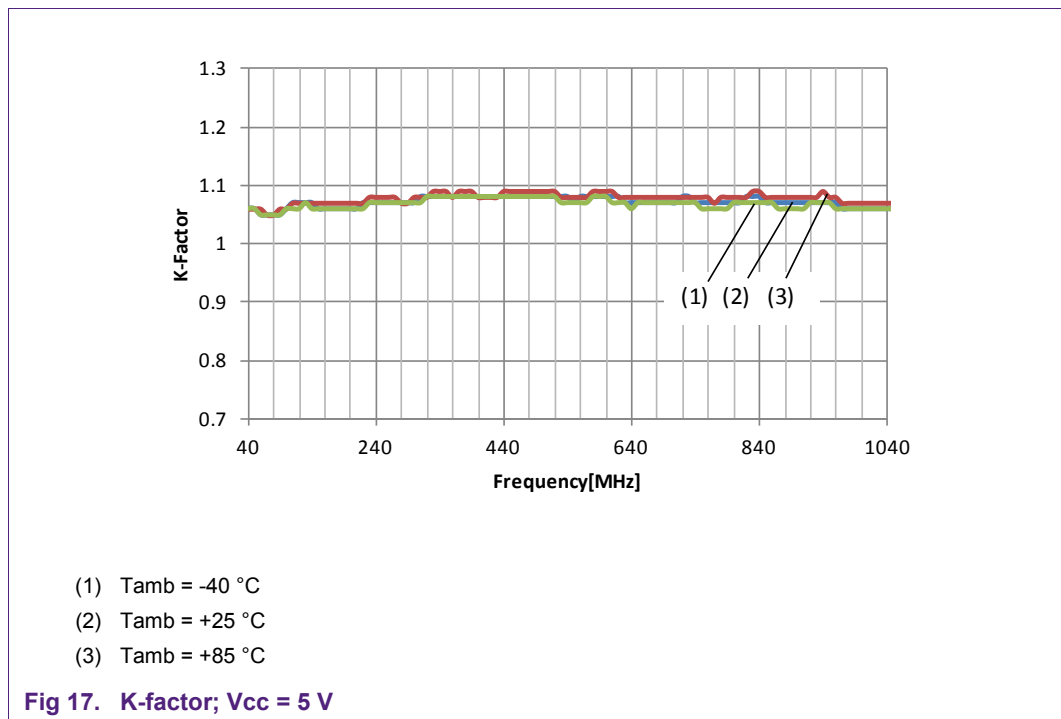
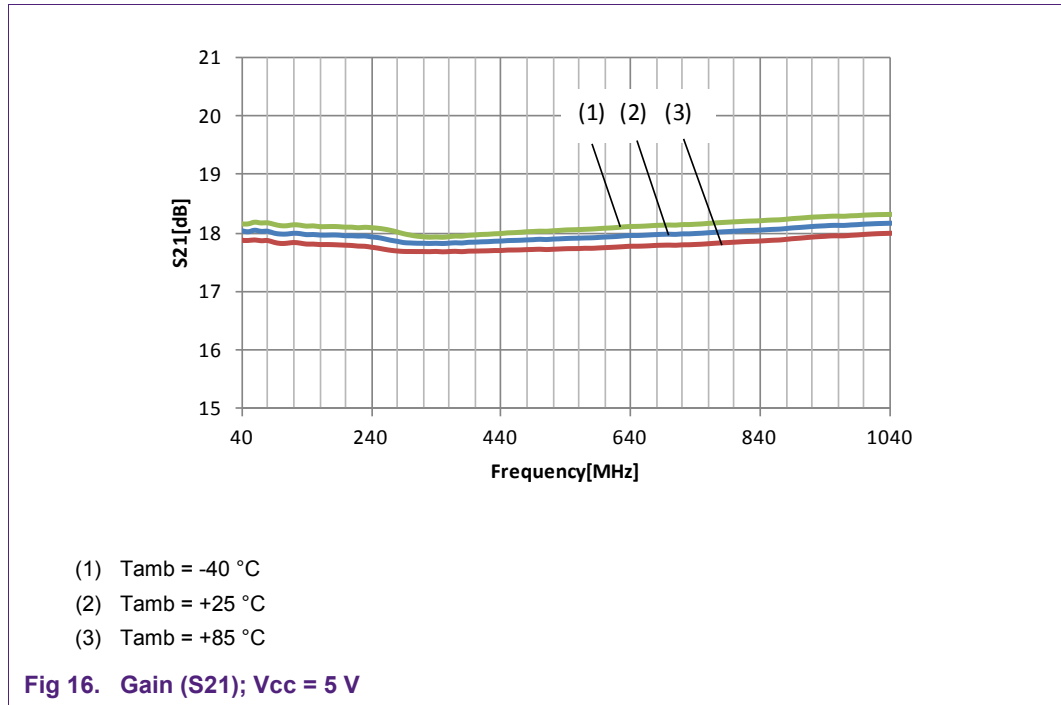

6.2 Distortion

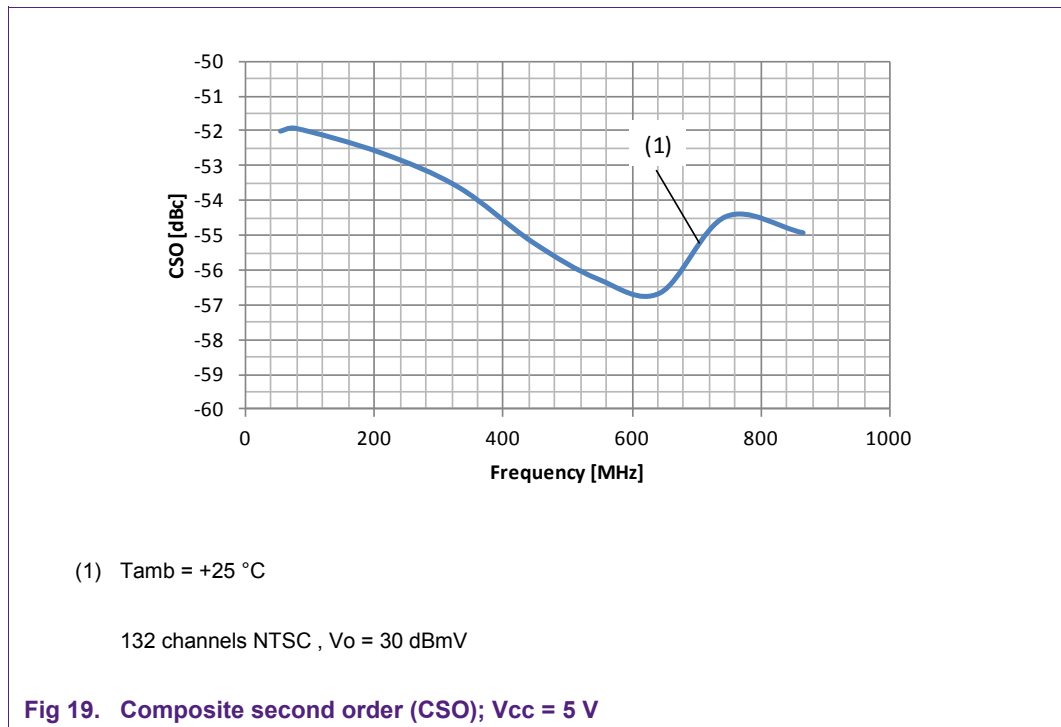
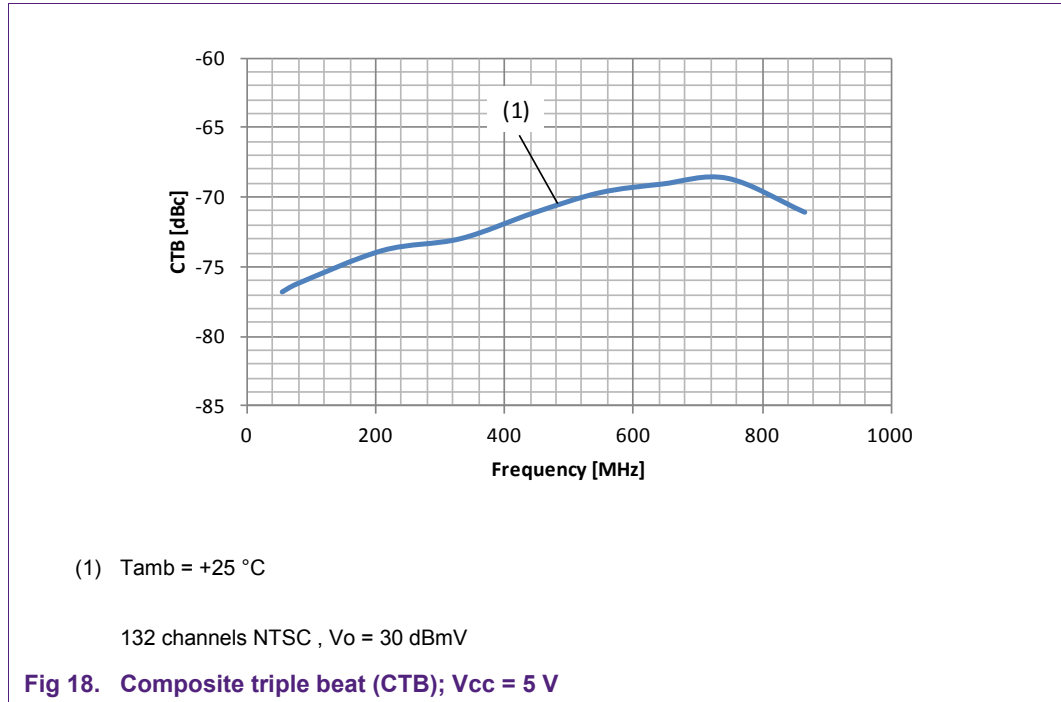

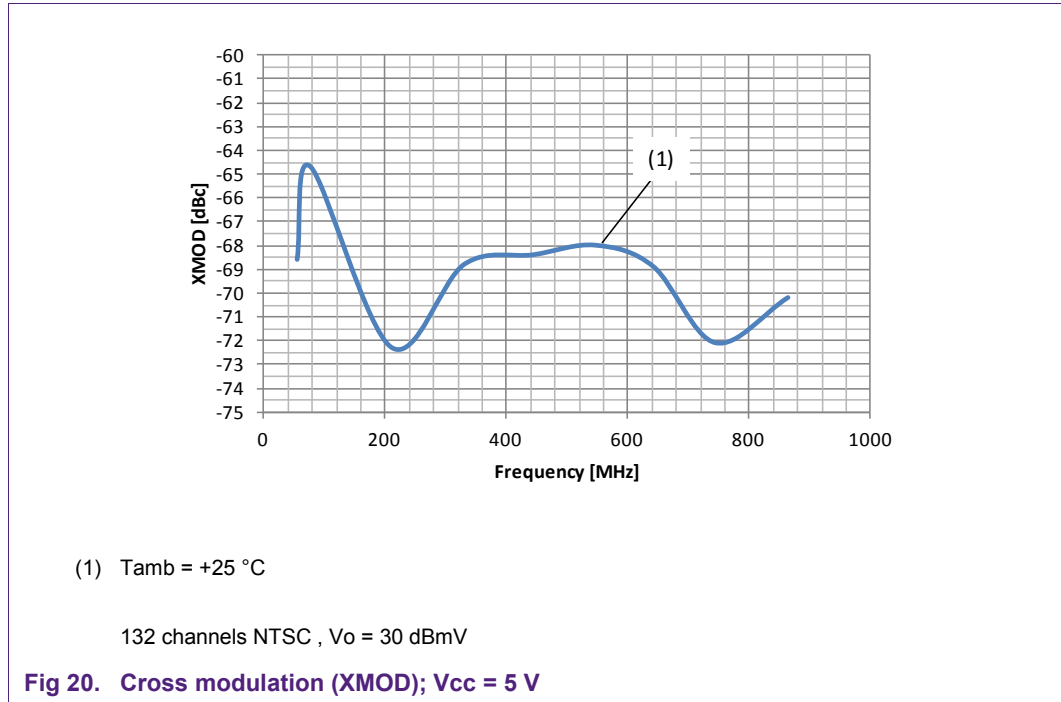

6.3 Noise figure

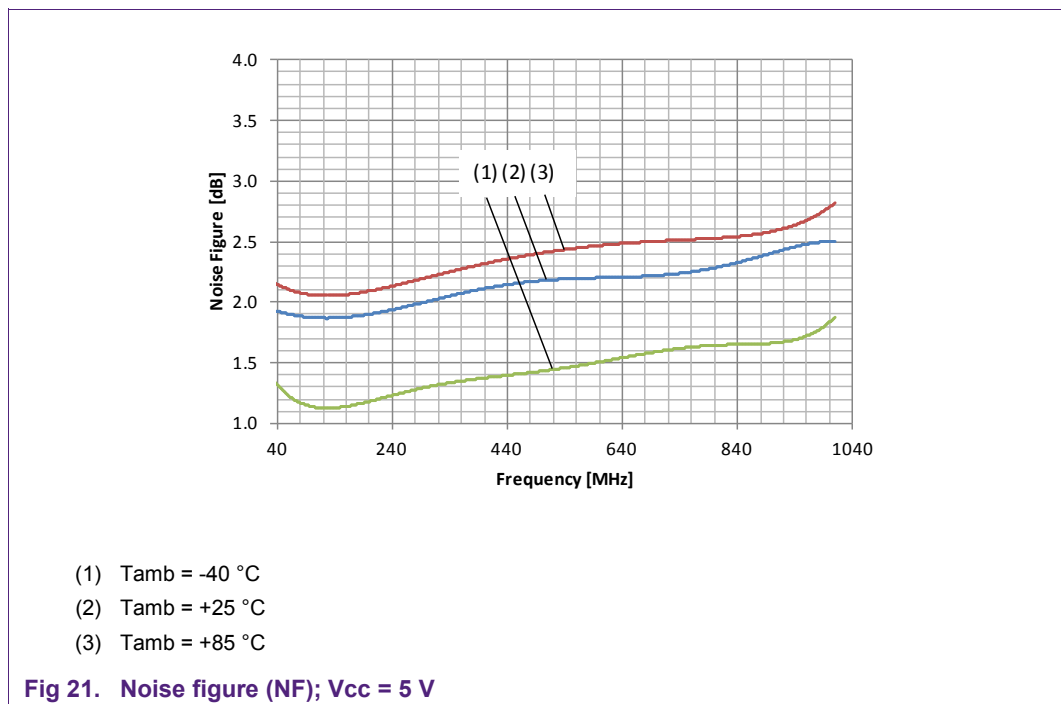

6.4 Output P1dB

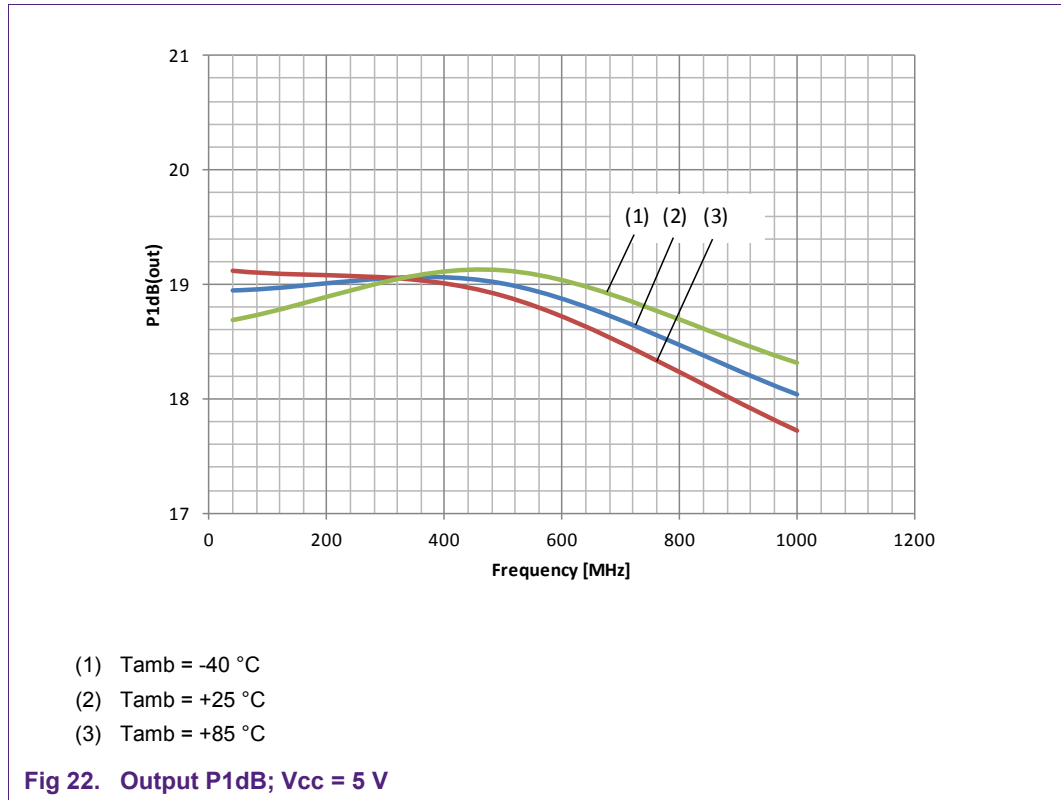

6.5 Output IP2

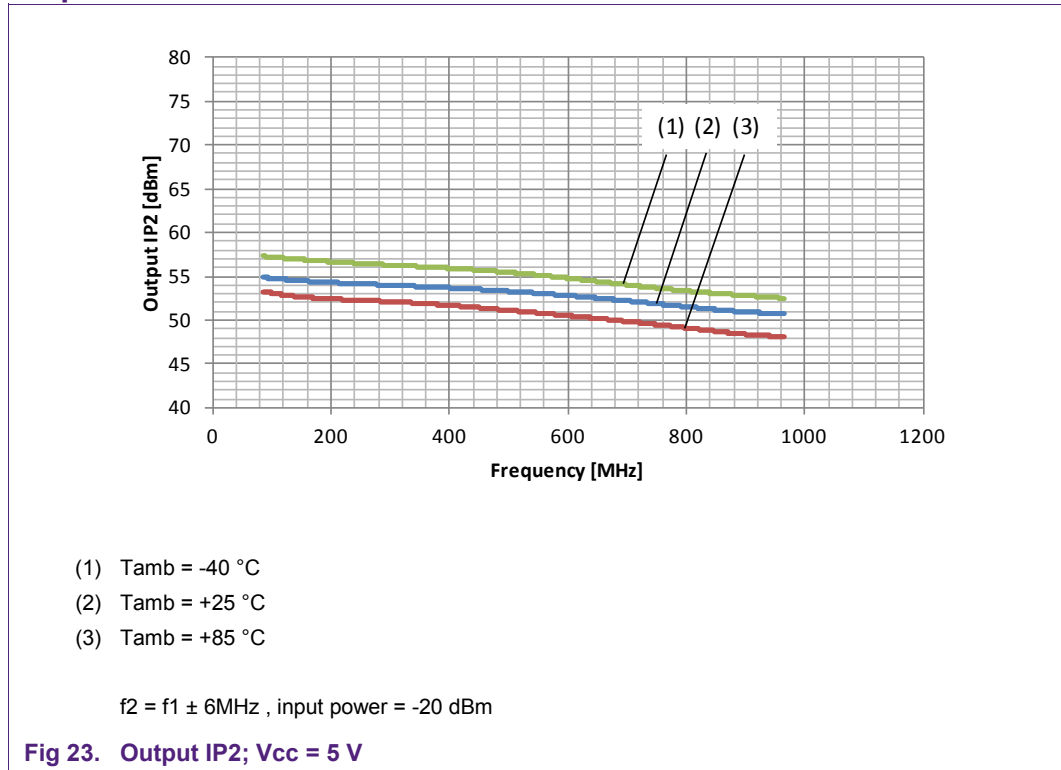

6.6 Output IP3

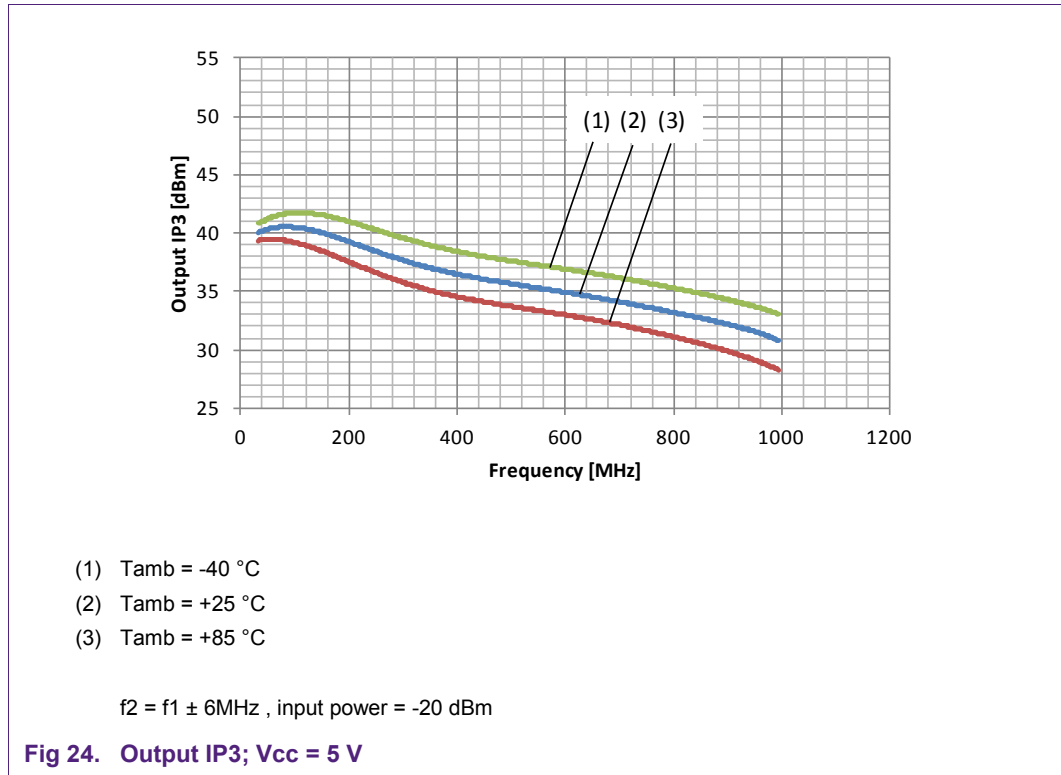

7. Abbreviations

Table 2. Abbreviations

Acronym	Description
AC	Alternating Current
CATV	Community Antenna TeleVision
DC	Direct Current
ESD	Electro Static Discharge
MMIC	Monolithic Microwave Integrated Circuit
NTSC	National Television Standards Committee
PCB	Printed Circuit Board
RF	Radio Frequency
SMD	Surface Mounted Device

8. Legal information

8.1 Definitions

Draft — The document is a draft version only. The content is still under internal review and subject to formal approval, which may result in modifications or additions. NXP Semiconductors does not give any representations or warranties as to the accuracy or completeness of information included herein and shall have no liability for the consequences of use of such information.

8.2 Disclaimers

Limited warranty and liability — Information in this document is believed to be accurate and reliable. However, NXP Semiconductors does not give any representations or warranties, expressed or implied, as to the accuracy or completeness of such information and shall have no liability for the consequences of use of such information. NXP Semiconductors takes no responsibility for the content in this document if provided by an information source outside of NXP Semiconductors.

In no event shall NXP Semiconductors be liable for any indirect, incidental, punitive, special or consequential damages (including - without limitation - lost profits, lost savings, business interruption, costs related to the removal or replacement of any products or rework charges) whether or not such damages are based on tort (including negligence), warranty, breach of contract or any other legal theory.

Notwithstanding any damages that customer might incur for any reason whatsoever, NXP Semiconductors' aggregate and cumulative liability towards customer for the products described herein shall be limited in accordance with the Terms and conditions of commercial sale of NXP Semiconductors.

Right to make changes — NXP Semiconductors reserves the right to make changes to information published in this document, including without limitation specifications and product descriptions, at any time and without notice. This document supersedes and replaces all information supplied prior to the publication hereof.

Suitability for use — NXP Semiconductors products are not designed, authorized or warranted to be suitable for use in life support, life-critical or safety-critical systems or equipment, nor in applications where failure or malfunction of an NXP Semiconductors product can reasonably be expected to result in personal injury, death or severe property or environmental damage. NXP Semiconductors and its suppliers accept no liability for inclusion and/or use of NXP Semiconductors products in such equipment or applications and therefore such inclusion and/or use is at the customer's own risk.

Applications — Applications that are described herein for any of these products are for illustrative purposes only. NXP Semiconductors makes no representation or warranty that such applications will be suitable for the specified use without further testing or modification.

Customers are responsible for the design and operation of their applications and products using NXP Semiconductors products, and NXP

Semiconductors accepts no liability for any assistance with applications or customer product design. It is customer's sole responsibility to determine whether the NXP Semiconductors product is suitable and fit for the customer's applications and products planned, as well as for the planned application and use of customer's third party customer(s). Customers should provide appropriate design and operating safeguards to minimize the risks associated with their applications and products.

NXP Semiconductors does not accept any liability related to any default, damage, costs or problem which is based on any weakness or default in the customer's applications or products, or the application or use by customer's third party customer(s). Customer is responsible for doing all necessary testing for the customer's applications and products using NXP Semiconductors products in order to avoid a default of the applications and the products or of the application or use by customer's third party customer(s). NXP does not accept any liability in this respect.

Export control — This document as well as the item(s) described herein may be subject to export control regulations. Export might require a prior authorization from national authorities.

Evaluation products — This product is provided on an "as is" and "with all faults" basis for evaluation purposes only. NXP Semiconductors, its affiliates and their suppliers expressly disclaim all warranties, whether express, implied or statutory, including but not limited to the implied warranties of non-infringement, merchantability and fitness for a particular purpose. The entire risk as to the quality, or arising out of the use or performance, of this product remains with customer.

In no event shall NXP Semiconductors, its affiliates or their suppliers be liable to customer for any special, indirect, consequential, punitive or incidental damages (including without limitation damages for loss of business, business interruption, loss of use, loss of data or information, and the like) arising out the use of or inability to use the product, whether or not based on tort (including negligence), strict liability, breach of contract, breach of warranty or any other theory, even if advised of the possibility of such damages.

Notwithstanding any damages that customer might incur for any reason whatsoever (including without limitation, all damages referenced above and all direct or general damages), the entire liability of NXP Semiconductors, its affiliates and their suppliers and customer's exclusive remedy for all of the foregoing shall be limited to actual damages incurred by customer based on reasonable reliance up to the greater of the amount actually paid by customer for the product or five dollars (US\$5.00). The foregoing limitations, exclusions and disclaimers shall apply to the maximum extent permitted by applicable law, even if any remedy fails of its essential purpose.

8.3 Trademarks

Notice: All referenced brands, product names, service names and trademarks are property of their respective owners.

9. List of figures

Fig 1.	BGA3018 evaluation circuit.....	4
Fig 2.	BGA3018 evaluation board layout	5
Fig 3.	Input matching (S11); Vcc = 8 V	7
Fig 4.	Output matching (S22); Vcc = 8 V	7
Fig 5.	Gain (S21); Vcc = 8 V	8
Fig 6.	K-factor; Vcc = 8 V	8
Fig 7.	Composite triple beat (CTB); Vcc = 8 V	9
Fig 8.	Composite second order (CSO); Vcc = 8 V	9
Fig 9.	Cross modulation (XMOD); Vcc = 8 V.....	10
Fig 10.	Noise figure (NF); Vcc = 8 V	10
Fig 11.	Output P1dB; Vcc = 8 V	11
Fig 12.	Output IP2; Vcc = 8 V	11
Fig 13.	Output IP3; Vcc = 8 V	12
Fig 14.	Input matching (S11); Vcc = 5 V	13
Fig 15.	Output matching (S22); Vcc = 5 V	13
Fig 16.	Gain (S21); Vcc = 5 V	14
Fig 17.	K-factor; Vcc = 5 V	14
Fig 18.	Composite triple beat (CTB); Vcc = 5 V	15
Fig 19.	Composite second order (CSO); Vcc = 5 V	15
Fig 20.	Cross modulation (XMOD); Vcc = 5 V.....	16
Fig 21.	Noise figure (NF); Vcc = 5 V	16
Fig 22.	Output P1dB; Vcc = 5 V	17
Fig 23.	Output IP2; Vcc = 5 V	17
Fig 24.	Output IP3; Vcc = 5 V	18

10. List of tables

Table 1. Evaluation board BOM.....6
Table 2. Abbreviations 19

11. Contents

1.	Introduction	3
2.	System features.....	3
3.	Customer evaluation kit contents.....	3
4.	Application Information	4
4.1	Evaluation board circuit	4
4.2	Evaluation board layout.....	5
4.3	Bill of materials	6
5.	Measurement results at Vcc = 8 V.....	7
5.1	S-Parameters	7
5.2	Distortion	9
5.3	Noise figure	10
5.4	Output P1dB.....	11
5.5	Output IP2	11
5.6	Output IP3	12
6.	Measurement results at Vcc = 5 V.....	13
6.1	S-Parameters	13
6.2	Distortion	15
6.3	Noise figure	16
6.4	Output P1dB.....	17
6.5	Output IP2	17
6.6	Output IP3	18
7.	Abbreviations	19
8.	Legal information	20
8.1	Definitions	20
8.2	Disclaimers.....	20
8.3	Trademarks	20
9.	List of figures.....	21
10.	List of tables	22
11.	Contents.....	23

Please be aware that important notices concerning this document and the product(s) described herein, have been included in the section 'Legal information'.
