

IND080 Hornet: Non-Isolated DC-DC Voltage Regulator Modules

12Vdc input; 0.8Vdc to 2Vdc output; 80W Max Power



Applications

- ✓ Industrial Equipment
- ✓ Control Boards
- ✓ Test Equipment

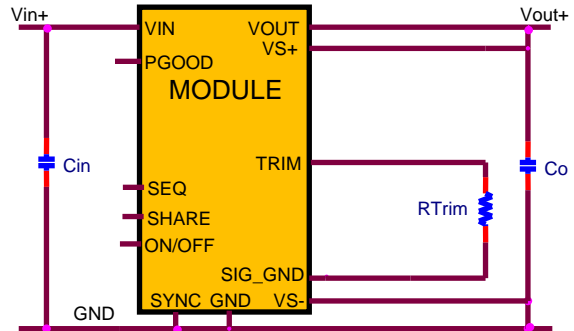

- 12V Input voltage with $\pm 20\%$ Tolerance
- Output voltage programmable from 0.8Vdc to 2Vdc via external resistor
- Remote On/Off for optional external control
- Power Good signal for external monitoring
- Fixed switching frequency
- Output overcurrent protection (non-latching)
- Share and Sequence available for advanced loads

- Small size: 33.02 mm x 13.46 mm x 10.9 mm (1.3 in x 0.53 in x 0.429 in)
- Operating range: -40°C to 105°C ambient
- Operating shock to 40G per Mil Std. 810F, Method 516.4 Procedure I
- Operating vibration per Mil Std. 810F, Method 514.5 Procedure I

Process and Safety

- Qualified for 1000h High Temperature Operating Bias, 1000h 85RH/85°C Temperature, Humidity and Bias, 700 cycle -40 to 125°C thermal cycling
- ANSI/UL# 60950-1 2nd Revised October 14, 2014, CSA+ C22.2 No. 60950-1-07, Second Ed. + A2:2014 (MOD) Recognized, DIN EN 60950-1:2006 + A11:2009 + A1:2010 + A12:2011, + A2:2013 (VDE+ 0805-1) Licensed
- ISO** 9001 and ISO 14001 certified manufacturing facilities
- Compliant to RoHS II EU "Directive 2011/65/EU"
- Compatible in a Pb-free or SnPb reflow environment.
- Suitable for aqueous clean.
- Suitable for conformal coating with dip and vapor deposition. Conformal coating can provide the protection to meet Salt Fog Test per IEC 60068-2-52 (Severity 3) and Mixed Gas Flow test per Telcordia GR-3108 Outdoor Levels.
- 3 year warranty

Device Code	Input Voltage	Output Voltage	Output Current (Max.)	On/Off Logic	Comcode
IND080	9.6 – 14.4Vdc	0.6 – 2.0Vdc	40A	Negative	1600102901A

Thermal Performance

Full rated output with natural convection up to 63°C at 1.2Vout and up to 60°C at 1.8Vout. Thermal curves for 1.2V, and 1.8Vout below.

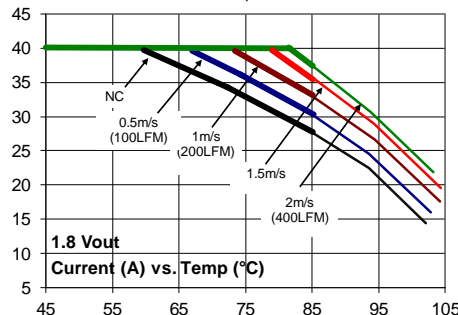
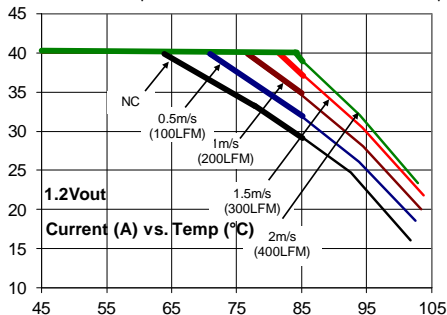

Electrical Specifications

Parameter	Device	Symbol	Min	Typ	Max	Unit
Operating Input Voltage	All	V _{IN}	9.6	12	14.4	Vdc
Input No Load Current (V _{IN} = 12.0Vdc, I _O = 0, module enabled)	V _{O,set} = 2Vdc	I _{IN,No load}		104		mA
External Capacitance, Ceramic ESR ≥ 1 mΩ	All	C _{O,max}	6x47	—	6x47*	μF
Efficiency 12V _{INDC} , T _A =25°C, I=12A, V _O =1.2 to 5Vdc		η	82.8(1.2V), 88.2(1.8V), 91.6(3.3V), 93.9(5V)			%
Switching Frequency	All	f _{sw}	—	600	—	kHz
Output Voltage (Over all line, load, and temperature conditions)	All	V _{O, set}	-3.0	—	+3.0	% V _{O, set}
On/Off Logic High (MODULE OFF) Input High Voltage	All	V _{IH}	2	—	14.4	Vdc
On/ Off Logic Low (MODULE ON) Input Low Voltage	All	V _{IL}	-0.2	—	0.4	Vdc
PGOOD (Power Good)						
Signal Interface Open Drain, V_{supply} ≤ 5VDC						
Overshoot threshold for PGOOD ON	All		103	108	113	%V _{O, set}
Overshoot threshold for PGOOD OFF	All		105	110	115	%V _{O, set}
Undershoot threshold for PGOOD ON	All		87	92	97	%V _{O, set}
Undershoot threshold for PGOOD OFF	All		85	90	95	%V _{O, set}
Pulldown resistance of PGOOD pin	All				50	Ω
Sink current capability into PGOOD pin	All				5	mA
Frequency Synchronization (SYNC)						
Synchronization Frequency Range	All		350		480	kHz
High-Level Input Voltage	All	V _{IH}	2.0			V
Low-Level Input Voltage	All	V _{IL}			0.4	V
Input Current, SYNC	All	I _{SYNC}			100	nA
Minimum Pulse Width, SYNC	All	t _{SYNC}	100			ns
Maximum SYNC rise time	All	t _{SYNC_SH}	100			ns

*Additional External Capacitance possible using Tunable Loop

Characteristic Curves

The following figures provide typical characteristics for the IND080 Hornet at 25°C.

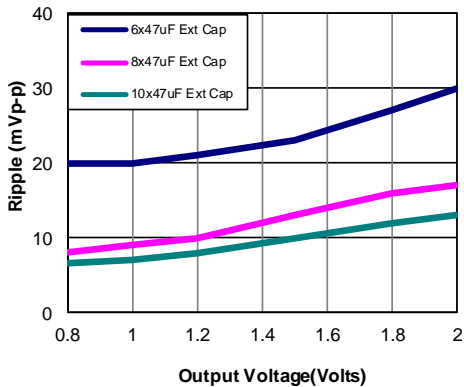

Figure 1. Output Ripple Voltage(20MHz BW) for various output voltages and external caps @12Vin. Additional Decoupling cap of 0.1uF used on input and output side

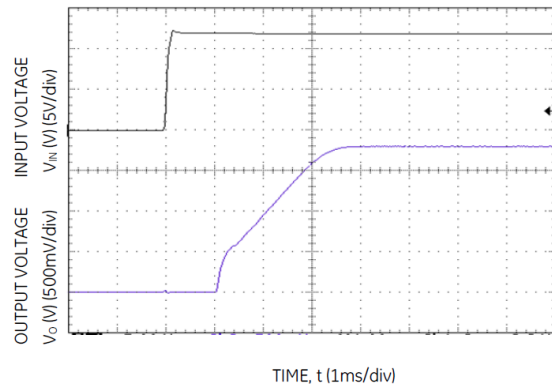

Figure 2. Typical Start-up using Input Voltage (Vin=12V, Vout = Vout, max, Iout = Iout, max)

Trim

Without an external resistor between Trim and GND pins, the output of the module will be 0.6Vdc. R_{trim} for a desired output voltage, should be as per the following table. The formula in the last column helps determine R_{trim} for other voltages.

V _O (V)	0.9	1.2	1.5	1.8	$R_{trim} = \left[\frac{12}{(V_o - 0.6)} \right] k\Omega$
R _{trim} (kΩ)	40	20	13.3	10	

Safety Considerations

For safety agency approval, the power module must be installed in compliance with the spacing and separation requirements of the end-use safety agency standards listed on the first page of this document. For the converter output to be considered meeting the requirements of safety extra-low voltage (SELV), the input must meet SELV requirements. The power module has extra-low voltage (ELV) outputs when all inputs are ELV. The input to these units is to be provided with a fast-acting fuse with a maximum rating of 30A, 100V (for example, Littelfuse 456 series) in the positive input lead.

Tunable Loop

The module is designed for 1x47uF capacitor on its output. For applications where more than 1x47uF capacitors would be used on the output, an additional Resistor (R_{tune}) and Capacitor (C_{tune}) would be required in the circuit schematic to compensate for the additional capacitance. The placement is between the Sense+ pin and Trim pin as per figure below:

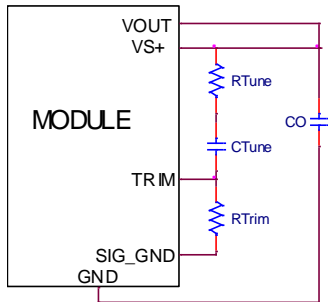

The recommended values for R_{tune} and C_{tune} for different amounts of external capacitance are as per the table below:

C _O	6x47μF	8x47μF	10x47μF	12x47μF	20x47μF
R _{TUNE}	330Ω	330Ω	330Ω	330Ω	200Ω
C _{TUNE}	330pF	820pF	1200pF	1500pF	3300pF

Figure 3. Circuit diagram showing connection of R_{TUNE} and C_{TUNE} to tune the control loop of the module

PowerGood (PG)

This is an open-drain output to indicate that the output voltage is within the regulation limits of the module. The PGOOD signal will be de-asserted to a low state if any condition such as overtemperature, overcurrent or loss of regulation occurs that would result in the output voltage going ±10% outside the setpoint value. The default value of PGOOD ON thresholds are set at ±8% of the nominal V_{set} value, and PGOOD OFF thresholds are set at ±10% of the nominal V_{set}. For example, if the nominal voltage (V_{set}) is set at 1.0V, then the PGOOD ON thresholds will be active anytime the output voltage is between 0.92V and 1.08V, and PGOOD OFF thresholds are active at 0.90V and 1.10V respectively. If not used, leave unconnected.

Synchronization (SYNC)

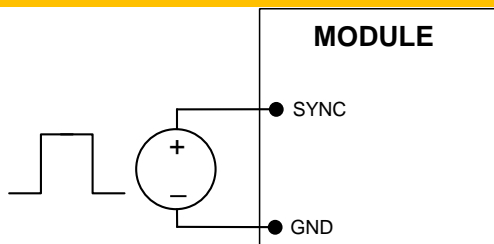

Figure 4. External source connections to synchronize switching frequency of the module.

The module switching frequency can be synchronized to a signal with an external frequency within a specified range. Synchronization can be done by using the external signal applied to the SYNC pin of the module as shown in Fig. 4, with the converter being synchronized by the rising edge of the external signal. The Electrical Specifications table specifies the requirements of the external SYNC signal. If the SYNC pin is not used, the module should free run at the default switching frequency. If synchronization is not being used, connect the SYNC pin to GND.

Recommended Pad Layout

Dimensions are in millimeters and (inches).

Tolerances: x.x mm ± 0.5 mm (x.xx in. ± 0.02 in.) [unless otherwise indicated] x.xx mm ± 0.25 mm (x.xxx in ± 0.010 in.)

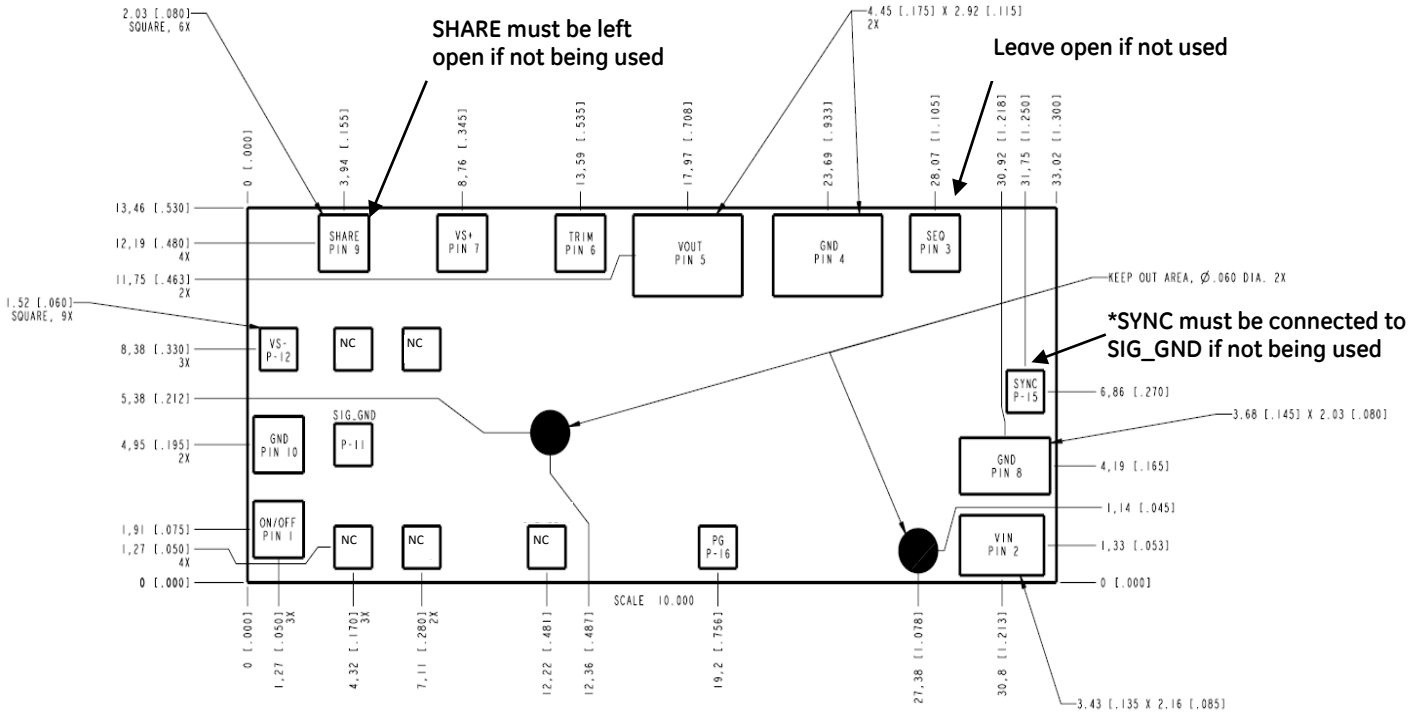

Active Load Sharing (Share Function)

For additional power requirements, the Mega DLynx™ power module is also equipped with paralleling capability. Up to five modules can be configured in parallel, with active load sharing.

To implement paralleling, the following conditions must be satisfied.

- All modules connected in parallel **must** be frequency synchronized where they are switching at the same frequency. This is done by using the SYNC function of the module and connecting to an external frequency source. Modules can be interleaved to reduce input ripple/filtering requirements.
- The share pins of all units in parallel must be connected together. The path of these connections should be as direct as possible.
- The remote sense connections to all modules should be made that to the same points for the output, i.e. all VS+ and VS- terminals for all modules are connected to the power bus at the same points.
- For converters operating in parallel, tunable loop components "RTUNE" and "CTUNE" must be selected to meet the required transient specification. For providing better noise immunity, we recommend that RTUNE value to be greater than 300Ω.

Some special considerations apply for design of converters in parallel operation:

- When sizing the number of modules required for parallel operation, take note of the fact that current sharing has some tolerance. In addition, under transient conditions such as a dynamic load change and during startup, all converter output currents will not be equal. To allow for such variation and avoid the likelihood of a converter shutting off due to a current overload, the total capacity of the paralleled system should be no more than 90% of the sum of the individual converters. As an example, for a system of four modules in parallel, the total current drawn should be less than 90% of (3 × 40A), i.e. less than 108 A.
- All modules should be turned ON and OFF together. This is so that all modules come up at the same time avoiding the problem of one converter sourcing current into the other leading to an overcurrent trip condition. To ensure that all modules come up simultaneously, the on/off pins of all paralleled converters should be tied together and the converters enabled and disabled using the on/off pin. Note that this means that converters in parallel cannot be digitally turned ON as that does not ensure that all modules being paralleled turn on at the same time.

- If the Sequencing function is being used to start-up and shut down modules and the module is being held to 0V by the tracking signal then there may be small deviations on the module output. This is due to controller duty cycle limitations encountered in trying to hold the voltage down near 0V.
- The share bus is not designed for redundant operation and the system will be non-functional upon failure of one of the units when multiple units are in parallel. In particular, if one of the converters shuts down during operation, the other converters may also shut down due to their outputs hitting current limit. In such a situation, unless a coordinated restart is ensured, the system may never properly restart since different converters will try to restart at different times causing an overload condition and subsequent shutdown. This situation can be avoided by having an external output voltage monitor circuit that detects a shutdown condition and forces all converters to shut down and restart together.

When not using the active load share feature, share pins should be left unconnected.

Output Voltage Sequencing

The voltage applied to the SEQ pin should be scaled down by the same ratio as used to scale the output voltage down to the reference voltage of the module. Minimum recommended delay between the ON/OFF signal and the sequencing signal is 10ms to ensure that the module output is ramped up according to the sequencing signal. Final value of the sequencing voltage must be set higher than the set-point voltage of the module. The module's output can track the SEQ pin signal with slopes of up to 0.5V/msec during power-up or power-down.

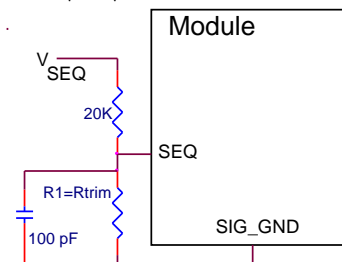

Figure 5. Circuit showing connection of the sequencing signal to the SEQ pin.

Nozzle Recommendations

The minimum recommended inside nozzle diameter for reliable operation is 3mm. The maximum nozzle outer diameter, which will safely fit within the allowable component spacing, is 7 mm.

Bottom Side / First Side Assembly

This module is not recommended for assembly on the bottom side of a customer board. If such an assembly is attempted, components may fall off the module during the second reflow process

Lead Free Soldering

The modules are lead-free (Pb-free) and RoHS compliant and fully compatible in a Pb-free soldering process. Failure to observe the instructions below may result in the failure of or cause damage to the modules and can adversely affect long-term reliability

MSL Rating

The modules have a MSL rating of 2a.

Pb-free Reflow Profile

Power Systems will comply with J-STD-020 Rev. D (Moisture/Reflow Sensitivity Classification for Nonhermetic Solid State Surface Mount Devices) for both Pb-free solder profiles and MSL classification procedures. The suggested Pb-free solder paste is Sn/Ag/Cu (SAC).

The following profile is the recommended linear reflow profile using Sn/Ag/Cu solder. Soldering outside of the recommended profile requires testing to verify results and performance.

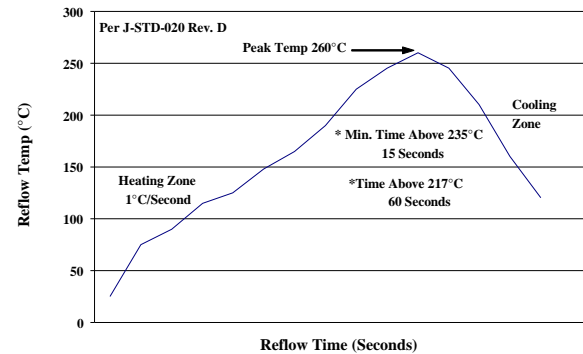

Storage and Handling

J-STD-033 Rev. A (Handling, Packing, Shipping and Use of Moisture/Reflow Sensitive Surface Mount Devices) is recommended. Moisture barrier bags (MBB) with desiccant are required for MSL ratings of 2 or greater. These sealed packages should not be broken until time of use. Once the original package is broken, the floor life of the product at conditions of $\leq 30^{\circ}\text{C}$ and 60% relative humidity varies according to the MSL rating (see J-STD-033A). The shelf life for dry packed SMT packages will be a minimum of 12 months from the bag seal date, when stored at the following conditions: $< 40^{\circ}\text{C}$, $< 90\%$ relative humidity.

Post Solder Cleaning and Drying Considerations

Post solder cleaning is usually the final circuit-board assembly process prior to electrical board testing. The result of inadequate cleaning and drying can affect both the reliability of a power module and the testability of the finished circuit-board assembly

Contact Us

For more information, call us at

USA/Canada:

+1 888 546 3243, or +1 972 244 9288

Asia-Pacific:

+86.021.54279977*808

Europe, Middle-East and Africa:

+49.89.878067-280

www.gecriticalpower.com



GE Critical Power reserves the right to make changes to the product(s) or information contained herein without notice, and no liability is assumed as a result of their use or application. No rights under any patent accompany the sale of any such product(s) or information.