

# Wide Input Range, No $R_{SENSE}^{TM}$ Current Mode Boost, Flyback and SEPIC Controller

## FEATURES

- High Efficiency (No Sense Resistor Required)
- Wide Input Voltage Range: 2.5V to 36V
- Current Mode Control Provides Excellent Transient Response
- High Maximum Duty Cycle (92% Typ)
- $\pm 2\%$  RUN Pin Threshold with 100mV Hysteresis
- $\pm 2\%$  Internal Voltage Reference
- Micropower Shutdown:  $I_Q = 10\mu A$
- Programmable Operating Frequency (65kHz to 900kHz) with One External Resistor
- Synchronizable to an External Clock Up to  $1.3 \times f_{OSC}$
- User-Controlled Pulse Skip or Burst Mode<sup>®</sup> Operation
- Internal 5.2V Low Dropout Voltage Regulator
- Output Overvoltage Protection
- Capable of Operating with a Sense Resistor for High Output Voltage Applications
- Small 10-Lead MSOP Package

## APPLICATIONS

- Telecom Power Supplies
- Portable Electronic Equipment

## DESCRIPTION

LTC<sup>®</sup>1871X is a wide input range, current mode, boost, flyback or SEPIC controller that drives an N-channel power MOSFET. LTC1871X is rated to 175°C junction temperature and is 100% tested at 175°C. Intended for low to medium power applications, it eliminates the need for a current sense resistor by utilizing the power MOSFET's on-resistance, thereby maximizing efficiency.

The IC's operating frequency can be set with an external resistor over a 65kHz to 900kHz range, and can be synchronized to an external clock using the MODE/SYNC pin. Burst Mode operation at light loads, a low minimum operating supply voltage of 2.5V and a low shutdown quiescent current of 10 $\mu A$  make the LTC1871X ideally suited for battery-operated systems.

For applications requiring constant frequency operation, Burst Mode operation can be defeated using the MODE/SYNC pin. Higher output voltage boost, SEPIC and flyback applications are possible with the LTC1871X by connecting the SENSE pin to a resistor in the source of the power MOSFET. The LTC1871X is available in the 10-lead MSOP package.

LT, LT, LTC, LTM, Linear Technology, the Linear logo and Burst Mode are registered trademarks and No  $R_{SENSE}$  is a trademark of Linear Technology Corporation. All other trademarks are the property of their respective owners.

## TYPICAL APPLICATION

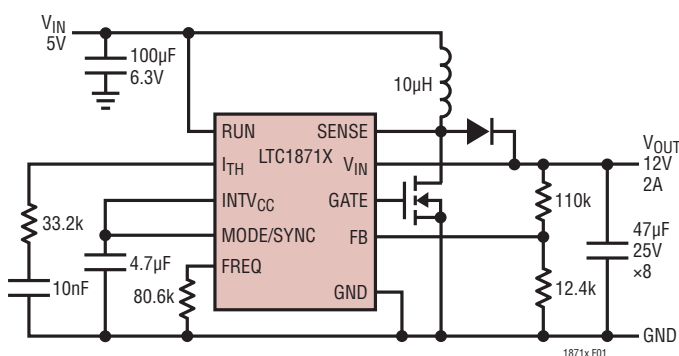
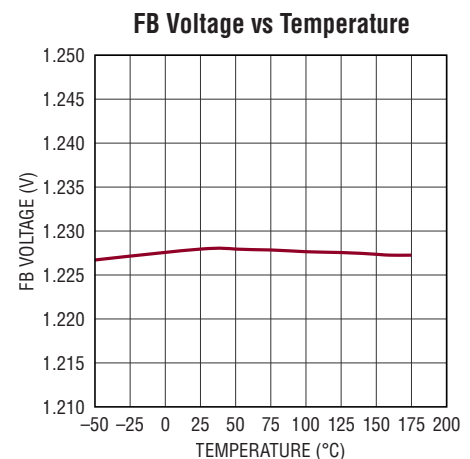

Figure 1. High Efficiency 5V Input, 12V Output Boost Converter (Bootstrapped)



1871x F01b

# LTC1871X

## ABSOLUTE MAXIMUM RATINGS

(Note 1)

$V_{IN}$ Voltage.....	- 0.3V to 36V
INTV <sub>CC</sub> Voltage .....	-0.3V to 7V
INTV <sub>CC</sub> Output Current.....	50mA
GATE Voltage .....	-0.3V to $V_{INTVCC} + 0.3V$
$I_{TH}$ , FB Voltages .....	-0.3V to 2.7V
RUN, MODE/SYNC Voltages .....	-0.3V to 7V
FREQ Voltage .....	-0.3V to 1.5V
SENSE Pin Voltage.....	-0.3V to 36V
Operating Junction Temperature Range (Notes 2, 3)	
LTC1871X.....	-40°C to 175°C
Storage Temperature Range .....	-65°C to 175°C
Lead Temperature (Soldering, 10 sec).....	300°C

## PIN CONFIGURATION

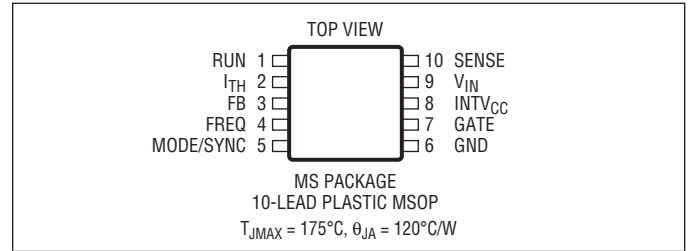

## ORDER INFORMATION <http://www.linear.com/product/LTC1871X#orderinfo>

LEAD FREE FINISH	TAPE AND REEL	PART MARKING	PACKAGE DESCRIPTION	TEMPERATURE RANGE
LTC1871XMS#PBF	LTC1871XMS#TRPBF	LTGZM	10-Lead Plastic MSOP	-40°C to 175°C

Consult LTC Marketing for parts specified with wider operating temperature ranges.

For more information on lead free part marking, go to: <http://www.linear.com/leadfree/>

For more information on tape and reel specifications, go to: <http://www.linear.com/tapeandreel/>. Some packages are available in 500 unit reels through designated sales channels with #TRMPBF suffix.

**ELECTRICAL CHARACTERISTICS** The ● denotes the specifications which apply over the specified operating junction temperature range, otherwise specifications are at  $T_A = 25^\circ\text{C}$  (Note 2).  $V_{IN} = V_{INTVCC} = 5\text{V}$ ,  $V_{RUN} = 1.5\text{V}$ ,  $R_{FREQ} = 80\text{k}$ ,  $V_{MODE/SYNC} = 0\text{V}$ , unless otherwise specified.

SYMBOL	PARAMETER	CONDITIONS	MIN	TYP	MAX	UNITS	
<b>Main Control Loop</b>							
$V_{IN(MIN)}$	Minimum Input Voltage		2.5			V	
		(Note 2)	● 2.5			V	
$I_Q$	Input Voltage Supply Current	(Note 4)					
	Continuous Mode	$V_{MODE/SYNC} = 5\text{V}$ , $V_{FB} = 1.4\text{V}$ , $V_{ITH} = 0.75\text{V}$		550	1000	$\mu\text{A}$	
		$V_{MODE/SYNC} = 5\text{V}$ , $V_{FB} = 1.4\text{V}$ , $V_{ITH} = 0.75\text{V}$ , (Note 2)	●	550	1200	$\mu\text{A}$	
	Burst Mode Operation, No Load	$V_{MODE/SYNC} = 0\text{V}$ , $V_{ITH} = 0.2\text{V}$ (Note 5)			250	500	$\mu\text{A}$
		$V_{MODE/SYNC} = 0\text{V}$ , $V_{ITH} = 0.2\text{V}$ (Note 5), (Note 2)	●		250	650	$\mu\text{A}$
Shutdown Mode	$V_{RUN} = 0\text{V}$			10	20	$\mu\text{A}$	
	$V_{RUN} = 0\text{V}$ , (Note 2)	●		10	65	$\mu\text{A}$	
$V_{RUN}^+$	Rising RUN Input Threshold Voltage			1.348		V	
$V_{RUN}^-$	Falling RUN Input Threshold Voltage		1.223	1.248	1.273	V	
		(Note 2)	● 1.179		1.465	V	
$V_{RUN(HYST)}$	RUN Pin Input Threshold Hysteresis		50	100	150	mV	
		(Note 2)	● 35		400	mV	
$I_{RUN}$	RUN Input Current			1	60	nA	
$V_{FB}$	Feedback Voltage	$V_{ITH} = 0.2\text{V}$ (Note 5)	1.218	1.230	1.242	V	
		$V_{ITH} = 0.2\text{V}$ (Note 5), (Note 2)	● 1.205		1.255	V	
$I_{FB}$	FB Pin Input Current	$V_{ITH} = 0.2\text{V}$ (Note 5)		18	60	nA	
$\Delta V_{FB}$ $\Delta V_{IN}$	Line Regulation	$3.5\text{V} \leq V_{IN} \leq 30\text{V}$		0.002	0.02	%/V	
		$3.5\text{V} \leq V_{IN} \leq 30\text{V}$ , (Note 2)	●	0.002	0.02	%/V	
$\Delta V_{FB}$ $\Delta V_{ITH}$	Load Regulation	$V_{MODE/SYNC} = 0\text{V}$ , $V_{ITH} = 0.5\text{V}$ to $0.9\text{V}$ (Note 5)	-1	-0.1		%	
		$V_{MODE/SYNC} = 0\text{V}$ , $V_{ITH} = 0.5\text{V}$ to $0.9\text{V}$ (Note 5) (Note 2)	● -1	-0.1		%	
$\Delta V_{FB(OV)}$	$\Delta\text{FB Pin, Overvoltage Lockout}$	$V_{FB(OV)} - V_{FB(NOM)}$ in Percent	2.5	6	10	%	
$g_m$	Error Amplifier Transconductance	$I_{TH}$ Pin Load = $\pm 5\mu\text{A}$ (Note 5)		650		$\mu\text{mho}$	
$V_{ITH(BURST)}$	Burst Mode Operation $I_{TH}$ Pin Voltage	Falling $I_{TH}$ Voltage (Note 5)		0.3		V	
$V_{SENSE(MAX)}$	Maximum Current Sense Input Threshold	Duty Cycle < 20%	115	150	185	mV	
		Duty Cycle < 20%, (Note 2)	● 100		200	mV	
$I_{SENSE(ON)}$	SENSE Pin Current (GATE High)	$V_{SENSE} = 0\text{V}$		35	50	$\mu\text{A}$	
$I_{SENSE(OFF)}$	SENSE Pin Current (GATE Low)	$V_{SENSE} = 30\text{V}$		0.1	5	$\mu\text{A}$	
<b>Oscillator</b>							
$f_{OSC}$	Oscillator Frequency	$R_{FREQ} = 80\text{k}$		250	300	350	kHz
		$R_{FREQ} = 80\text{k}$ , (Note 2)	●	240	300	375	kHz
	Oscillator Frequency Range			50		1000	kHz
		(Note 2)	●	65		900	kHz
$D_{MAX}$	Maximum Duty Cycle			87	92	97	%
		(Note 2)	●	87	92	97	%

## ELECTRICAL CHARACTERISTICS

The ● denotes the specifications which apply over the specified operating junction temperature range, otherwise specifications are at  $T_A = 25^\circ\text{C}$  (Note 2).  $V_{IN} = V_{INTVCC} = 5\text{V}$ ,  $V_{RUN} = 1.5\text{V}$ ,  $R_{FREQ} = 80\text{k}$ ,  $V_{MODE/SYNC} = 0\text{V}$ , unless otherwise specified.

SYMBOL	PARAMETER	CONDITIONS	MIN	TYP	MAX	UNITS
$f_{SYNC}/f_{OSC}$	Recommended Maximum Synchronized Frequency Ratio	$f_{OSC} = 300\text{kHz}$ (Note 6)		1.25	1.30	
		$f_{OSC} = 300\text{kHz}$ (Note 6), (Note 2)	●	1.25	1.30	
$t_{SYNC(MIN)}$	MODE/SYNC Minimum Input Pulse Width	$V_{SYNC} = 0\text{V}$ to $5\text{V}$		25		ns
$t_{SYNC(MAX)}$	MODE/SYNC Maximum Input Pulse Width	$V_{SYNC} = 0\text{V}$ to $5\text{V}$		$0.8/f_{OSC}$		ns
$V_{IL(MODE)}$	Low Level MODE/SYNC Input Voltage				0.3	V
		(Note 2)	●		0.3	V
$V_{IH(MODE)}$	High Level MODE/SYNC Input Voltage		1.2			V
		(Note 2)	●	1.2		V
$R_{MODE/SYNC}$	MODE/SYNC Input Pull-Down Resistance			50		k $\Omega$
$V_{FREQ}$	Nominal FREQ Pin Voltage			0.62		V

### Low Dropout Regulator

$V_{INTVCC}$	INTV <sub>CC</sub> Regulator Output Voltage	$V_{IN} = 7.5\text{V}$	5.0	5.2	5.4	V
$\frac{\Delta V_{INTVCC}}{\Delta V_{IN1}}$	INTV <sub>CC</sub> Regulator Line Regulation	$7.5\text{V} \leq V_{IN} \leq 15\text{V}$		8	25	mV
$\frac{\Delta V_{INTVCC}}{\Delta V_{IN2}}$	INTV <sub>CC</sub> Regulator Line Regulation	$15\text{V} \leq V_{IN} \leq 30\text{V}$		70	200	mV
$V_{LDO(LOAD)}$	INTV <sub>CC</sub> Load Regulation	$0 \leq I_{INTVCC} \leq 20\text{mA}$ , $V_{IN} = 7.5\text{V}$	-2	-0.2		%
$V_{DROPOUT}$	INTV <sub>CC</sub> Regulator Dropout Voltage	$V_{IN} = 5\text{V}$ , INTV <sub>CC</sub> Load = 20mA		280		mV
$I_{INTVCC}$	Bootstrap Mode INTV <sub>CC</sub> Supply Current in Shutdown	$RUN = 0\text{V}$ , $SENSE = 5\text{V}$		10	20	$\mu\text{A}$

### GATE Driver

$t_r$	GATE Driver Output Rise Time	$C_L = 3300\text{pF}$ (Note 7)		17	100	ns
$t_f$	GATE Driver Output Fall Time	$C_L = 3300\text{pF}$ (Note 7)		8	100	ns

**Note 1:** Stresses beyond those listed under Absolute Maximum Ratings may cause permanent damage to the device. Exposure to any Absolute Maximum Rating condition for extended periods may affect device reliability and lifetime.

**Note 2:** The LTC1871X is guaranteed over the full  $-40^\circ\text{C}$  to  $175^\circ\text{C}$  operating junction temperature range. High junction temperatures degrade operating lifetimes. Operating lifetime is derated at junction temperatures greater than  $125^\circ\text{C}$ .

**Note 3:**  $T_J$  is calculated from the ambient temperature  $T_A$  and power dissipation  $P_D$  according to the following formula:

$$T_J = T_A + (P_D \cdot 120^\circ\text{C/W})$$

**Note 4:** The dynamic input supply current is higher due to power MOSFET gate charging ( $Q_G \cdot f_{OSC}$ ). See Applications Information.

**Note 5:** The LTC1871X is tested in a feedback loop which servos  $V_{FB}$  to the reference voltage with the  $I_{TH}$  pin forced to the midpoint of its voltage range ( $0.3\text{V} \leq V_{ITH} \leq 1.2\text{V}$ , midpoint =  $0.75\text{V}$ ).

**Note 6:** In a synchronized application, the internal slope compensation gain is increased by 25%. Synchronizing to a significantly higher ratio will reduce the effective amount of slope compensation, which could result in subharmonic oscillation for duty cycles greater than 50%.

**Note 7:** Rise and fall times are measured at 10% and 90% levels.

# TYPICAL PERFORMANCE CHARACTERISTICS

**FB Voltage vs Temperature**

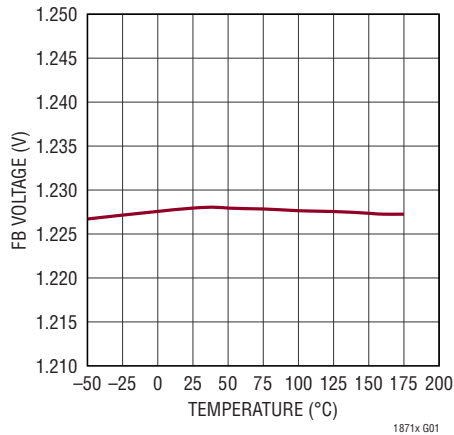

1871x G01

**FB Voltage Line Regulation**

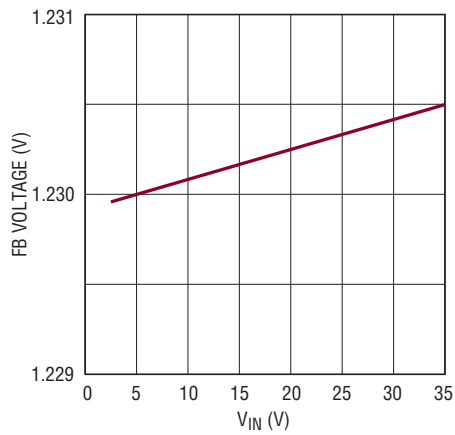

1871x G02

**FB Pin Current vs Temperature**

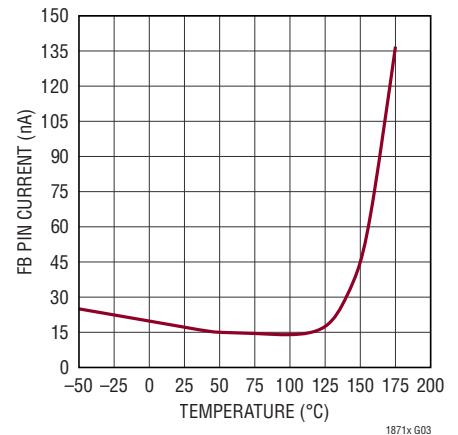

1871x G03

**Shutdown Mode I<sub>Q</sub> vs V<sub>IN</sub>**

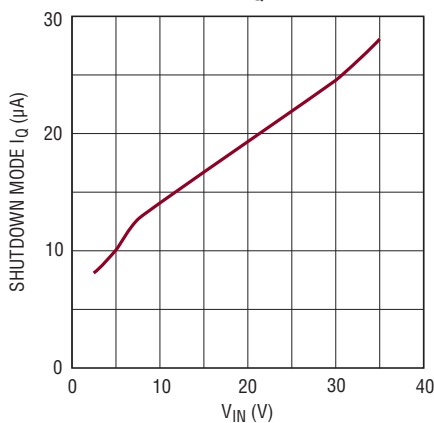

1871x G04

**Shutdown Mode I<sub>Q</sub> vs Temperature**

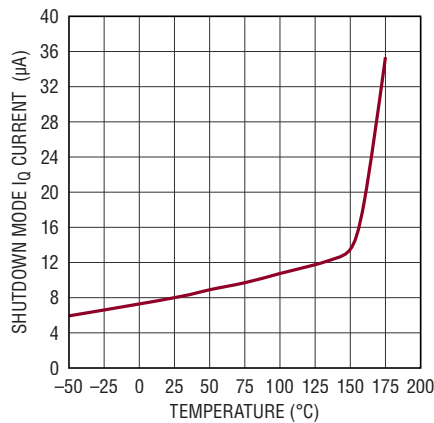

1871x G05

**Burst Mode I<sub>Q</sub> vs V<sub>IN</sub>**

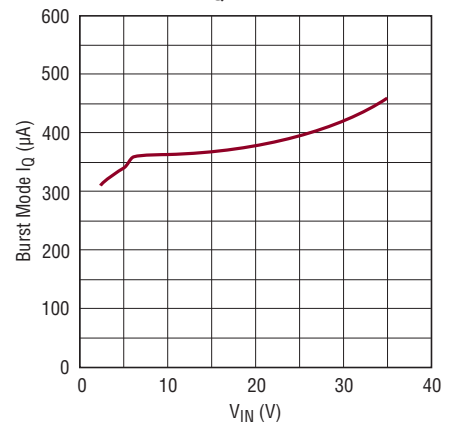

1871x G06

**Dynamic I<sub>Q</sub> vs Frequency**

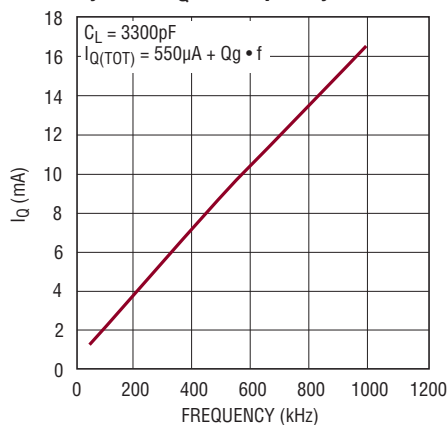

1871x G07

**Gate Drive Rise and Fall Time vs C<sub>L</sub>**

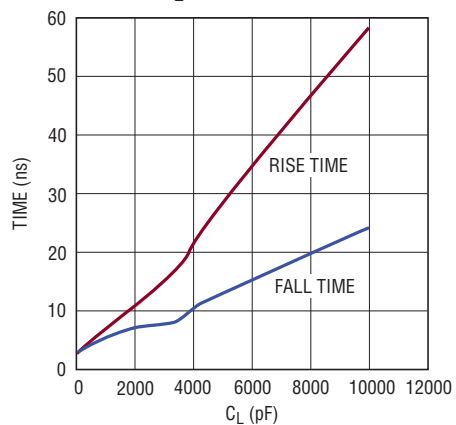

1871x G08

## TYPICAL PERFORMANCE CHARACTERISTICS

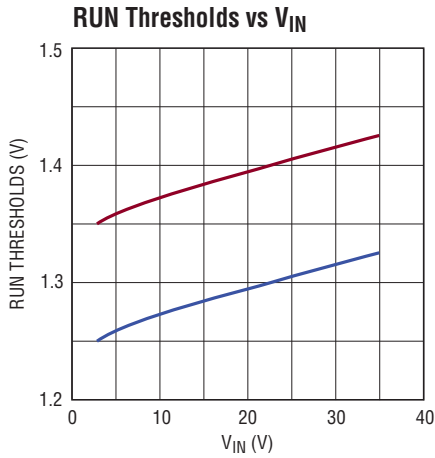

1871x G09

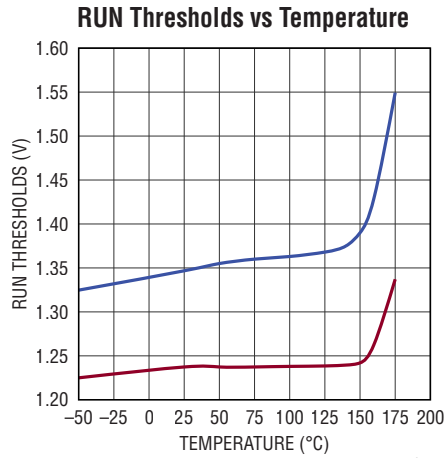

1871x G10

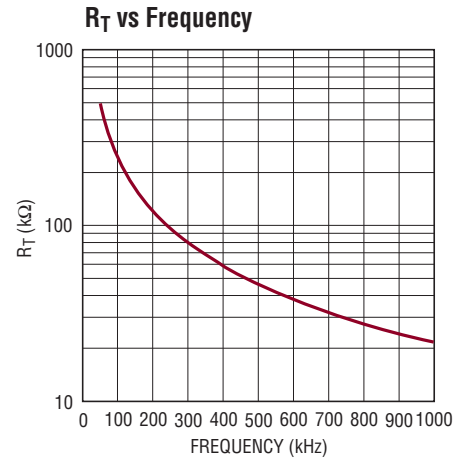

1871x G11

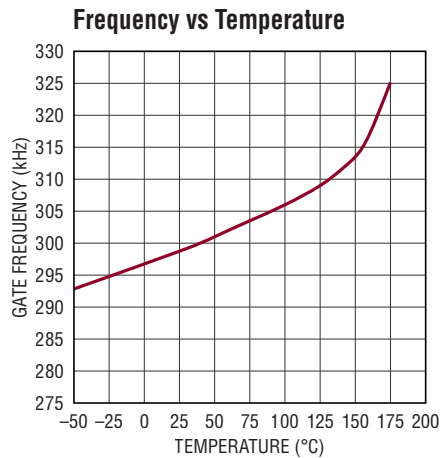

1871x G12

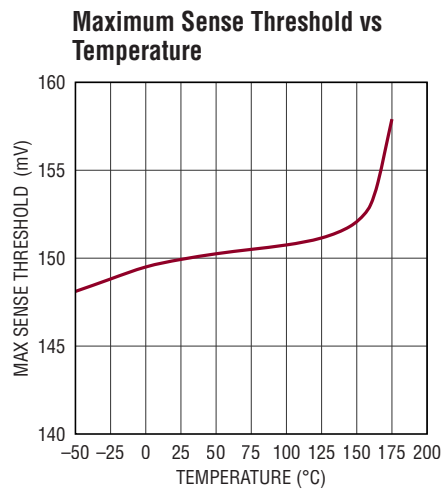

1871x G13

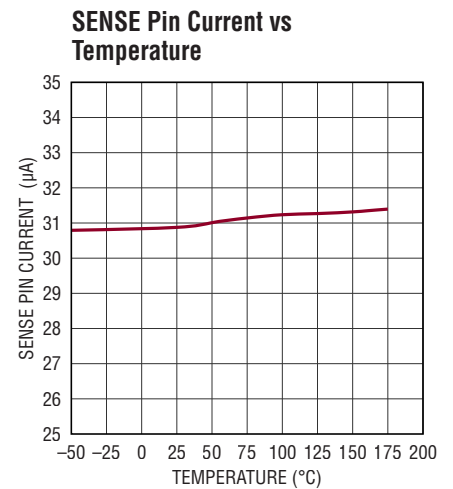

1871x G14

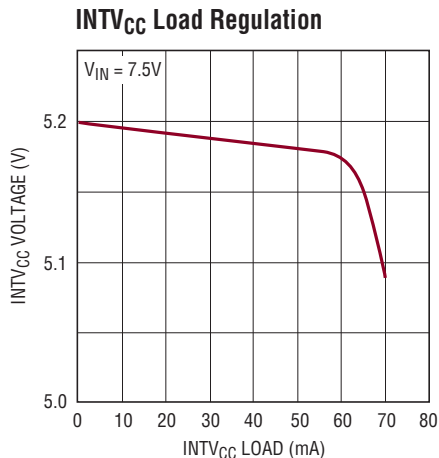

1871x G15

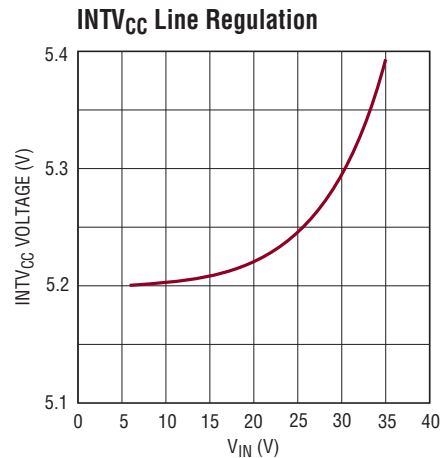

1871x G16

## PIN FUNCTIONS

**RUN (Pin 1):** The RUN pin provides the user with an accurate means for sensing the input voltage and programming the start-up threshold for the converter. The falling RUN pin threshold is nominally 1.248V and the comparator has 100mV of hysteresis for noise immunity. When the RUN pin is below this input threshold, the IC is shut down and the  $V_{IN}$  supply current is kept to a low value (typ 10 $\mu$ A). The Absolute Maximum Rating for the voltage on this pin is 7V.

**I<sub>TH</sub> (Pin 2):** Error Amplifier Compensation Pin. The current comparator input threshold increases with this control voltage. Nominal voltage range for this pin is 0V to 1.40V.

**FB (Pin 3):** Receives the feedback voltage from the external resistor divider across the output. Nominal voltage for this pin in regulation is 1.230V.

**FREQ (Pin 4):** A resistor from the FREQ pin to ground programs the operating frequency of the chip. The nominal voltage at the FREQ pin is 0.6V.

**MODE/SYNC (Pin 5):** This input controls the operating mode of the converter and allows for synchronizing the

operating frequency to an external clock. If the MODE/SYNC pin is connected to ground, Burst Mode operation is enabled. If the MODE/SYNC pin is connected to INTV<sub>CC</sub>, or if an external logic-level synchronization signal is applied to this input, Burst Mode operation is disabled and the IC operates in a continuous mode.

**GND (Pin 6):** Ground Pin.

**GATE (Pin 7):** Gate Driver Output.

**INTV<sub>CC</sub> (Pin 8):** The Internal 5.20V Regulator Output. The gate driver and control circuits are powered from this voltage. Decouple this pin locally to the IC ground with a minimum of 4.7 $\mu$ F low ESR tantalum or ceramic capacitor.

**V<sub>IN</sub> (Pin 9):** Main Supply Pin. Must be closely decoupled to ground.

**SENSE (Pin 10):** The Current Sense Input for the Control Loop. Connect this pin to the drain of the power MOSFET for  $V_{DS}$  sensing and highest efficiency. Alternatively, the SENSE pin may be connected to a resistor in the source of the power MOSFET. Internal leading edge blanking is provided for both sensing methods.

## BLOCK DIAGRAM

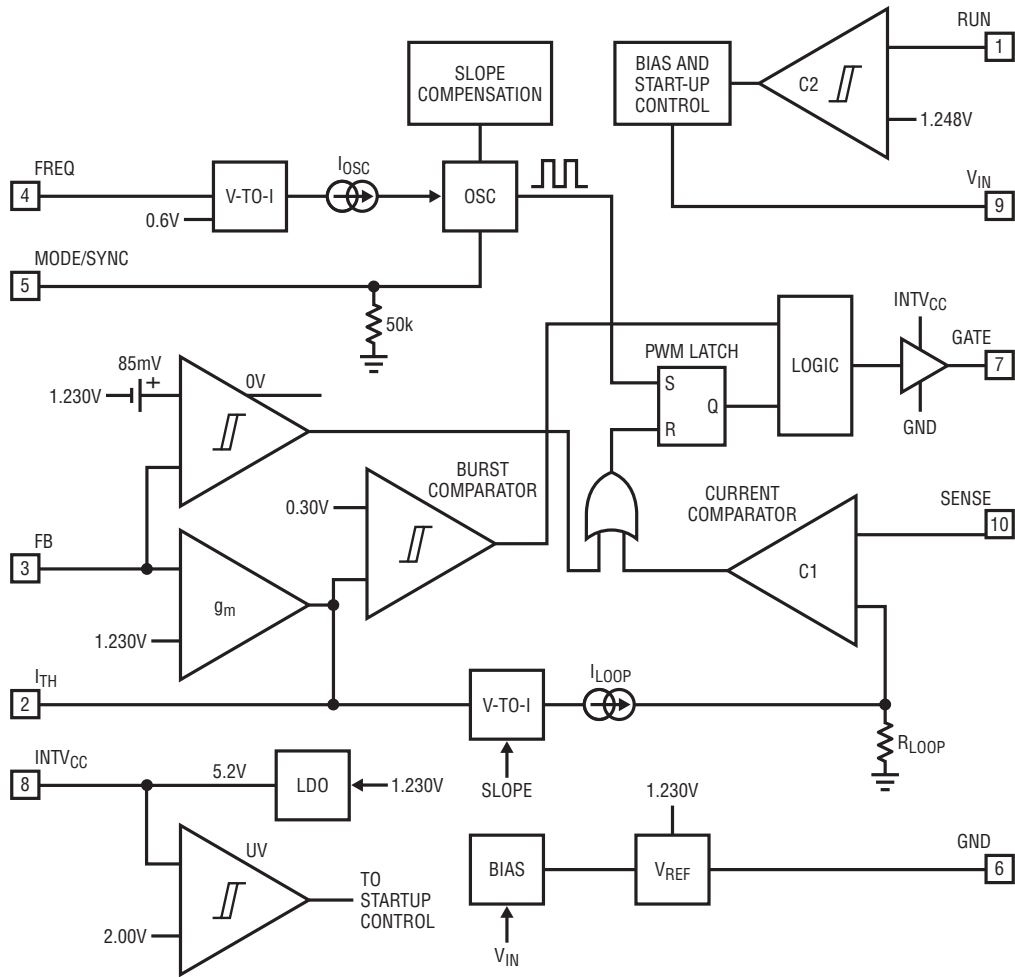

1871x BD



## OPERATION

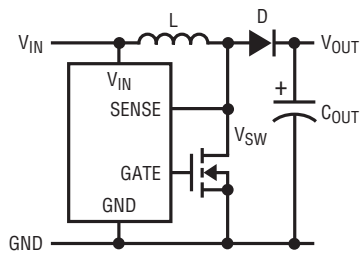

**2a. SENSE Pin Connection for Maximum Efficiency ( $V_{SW} < 36V$ )**

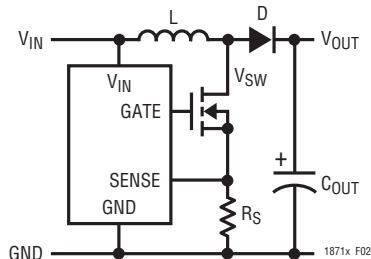

**2b. SENSE Pin Connection for Precise Control of Peak Current or for  $V_{SW} > 36V$**

**Figure 2. Using the SENSE Pin On the LTC1871**

The nominal operating frequency of the LTC1871X is programmed using a resistor from the FREQ pin to ground and can be controlled over a 65kHz to 900kHz range. In addition, the internal oscillator can be synchronized to an external clock applied to the MODE/SYNC pin and can be locked to a frequency between 100% and 130% of its nominal value. When the MODE/SYNC pin is left open, it is pulled low by an internal 50k resistor and Burst Mode operation is enabled. If this pin is taken above 2V or an external clock is applied, Burst Mode operation is disabled and the IC operates in continuous mode. With no load (or an extremely light load), the controller will skip pulses in order to maintain regulation and prevent excessive output ripple.

The RUN pin controls whether the IC is enabled or is in a low current shutdown state. A micropower 1.248V reference and comparator C2 allow the user to program the supply voltage at which the IC turns on and off (comparator C2 has 100mV of hysteresis for noise immunity). With the RUN pin below 1.248V, the chip is off and the input supply current is typically only 10 $\mu$ A.

An overvoltage comparator OV senses when the FB pin exceeds the reference voltage by 6.5% and provides a

reset pulse to the main RS latch. Because this RS latch is reset-dominant, the power MOSFET is actively held off for the duration of an output overvoltage condition.

The LTC1871X can be used either by sensing the voltage drop across the power MOSFET or by connecting the SENSE pin to a conventional shunt resistor in the source of the power MOSFET, as shown in Figure 2. Sensing the voltage across the power MOSFET maximizes converter efficiency and minimizes the component count, but limits the output voltage to the maximum rating for this pin (36V). By connecting the SENSE pin to a resistor in the source of the power MOSFET, the user is able to program output voltages significantly greater than 36V.

### Programming the Operating Mode

For applications where maximizing the efficiency at very light loads (e.g., <100 $\mu$ A) is a high priority, the current in the output divider could be decreased to a few microamps and Burst Mode operation should be applied (i.e., the MODE/SYNC pin should be connected to ground). In applications where fixed frequency operation is more critical than low current efficiency, or where the lowest output ripple is desired, pulse-skip mode operation should be used and the MODE/SYNC pin should be connected to the INTV<sub>CC</sub> pin. This allows discontinuous conduction mode (DCM) operation down to near the limit defined by the chip's minimum on-time (about 175ns). Below this output current level, the converter will begin to skip cycles in order to maintain output regulation. Figures 3 and 4 show the light load switching waveforms for Burst Mode and pulse-skip mode operation for the converter in Figure 1.

### Burst Mode Operation

Burst Mode operation is selected by leaving the MODE/SYNC pin unconnected or by connecting it to ground. In normal operation, the range on the I<sub>TH</sub> pin corresponding to no load to full load is 0.30V to 1.2V. In Burst Mode operation, if the error amplifier EA drives the I<sub>TH</sub> voltage below 0.525V, the buffered I<sub>TH</sub> input to the current comparator C1 will be clamped at 0.525V (which corresponds to 25% of maximum load current). The inductor current peak is then held at approximately 30mV divided by the power

## OPERATION

MOSFET  $R_{DS(ON)}$ . If the  $I_{TH}$  pin drops below 0.30V, the Burst Mode comparator B1 will turn off the power MOSFET and scale back the quiescent current of the IC to 250 $\mu$ A (sleep mode). In this condition, the load current will be supplied by the output capacitor until the  $I_{TH}$  voltage rises above the 50mV hysteresis of the burst comparator. At light loads, short bursts of switching (where the average inductor current is 20% of its maximum value) followed by long periods of sleep will be observed, thereby greatly improving converter efficiency. Oscilloscope waveforms illustrating Burst Mode operation are shown in Figure 3.

### Pulse-Skip Mode Operation

With the MODE/SYNC pin tied to a DC voltage above 2V, Burst Mode operation is disabled. The internal, 0.525V buffered  $I_{TH}$  burst clamp is removed, allowing the  $I_{TH}$  pin to directly control the current comparator from no load to full load. With no load, the  $I_{TH}$  pin is driven below 0.30V, the power MOSFET is turned off and sleep mode is invoked. Oscilloscope waveforms illustrating this mode of operation are shown in Figure 4.

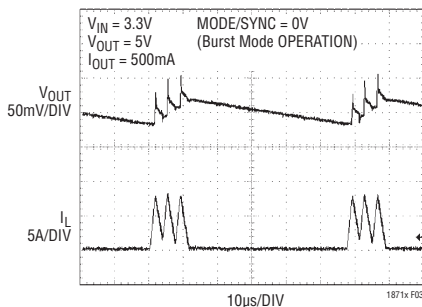

**Figure 3. LTC1871X Burst Mode Operation (MODE/SYNC = 0V) at Low Output Current**

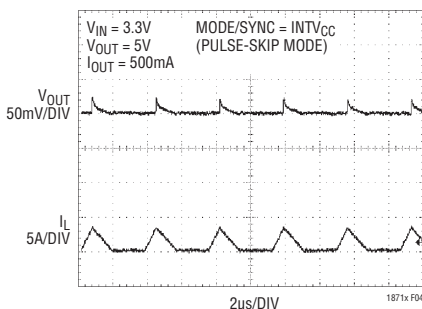
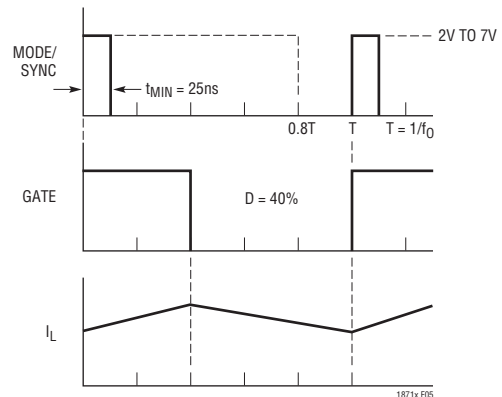

**Figure 4. LTC1871X Low Output Current Operation with Burst Mode Operation Disabled (MODE/SYNC = INTV<sub>CC</sub>)**

When an external clock signal drives the MODE/SYNC pin at a rate faster than the chip's internal oscillator, the oscillator will synchronize to it. In this synchronized mode, Burst Mode operation is disabled. The constant frequency associated with synchronized operation provides a more controlled noise spectrum from the converter, at the expense of overall system efficiency of light loads.

When the oscillator's internal logic circuitry detects a synchronizing signal on the MODE/SYNC pin, the internal oscillator ramp is terminated early and the slope compensation is increased by approximately 30%. As a result, in applications requiring synchronization, it is recommended that the nominal operating frequency of the IC be programmed to be about 75% of the external clock frequency. Attempting to synchronize to too high an external frequency (above 1.3 $f_0$ ) can result in inadequate slope compensation and possible subharmonic oscillation (or jitter).

The external clock signal must exceed 2V for at least 25ns, and should have a maximum duty cycle of 80%, as shown in Figure 5. The MOSFET turn on will synchronize to the rising edge of the external clock signal.



**Figure 5. MODE/SYNC Clock Input and Switching Waveforms for Synchronized Operation**

## APPLICATIONS INFORMATION

### Programming the Operating Frequency

The choice of operating frequency and inductor value is a tradeoff between efficiency and component size. Low frequency operation improves efficiency by reducing MOSFET and diode switching losses. However, lower frequency operation requires more inductance for a given amount of load current.

The LTC1871X uses a constant frequency architecture that can be programmed over a 65kHz to 900kHz range with a single external resistor from the FREQ pin to ground, as shown in Figure 1. The nominal voltage on the FREQ pin is 0.6V, and the current that flows into the FREQ pin is used to charge and discharge an internal oscillator capacitor. A graph for selecting the value of  $R_T$  for a given operating frequency is shown in Figure 6.

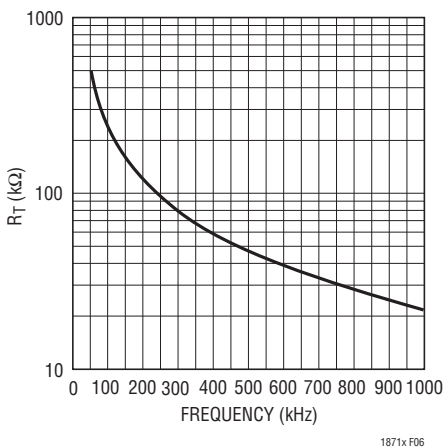

Figure 6. Timing Resistor ( $R_T$ ) Value

### INTV<sub>CC</sub> Regulator Bypassing and Operation

An internal, P-channel low dropout voltage regulator produces the 5.2V supply which powers the gate driver and logic circuitry within the LTC1871X, as shown in Figure 7. The INTV<sub>CC</sub> regulator can supply up to 50mA and must be bypassed to ground immediately adjacent to the IC pins with a minimum of 4.7μF tantalum or ceramic capacitor. Good bypassing is necessary to supply the high transient currents required by the MOSFET gate driver.

For input voltages that don't exceed 7V (the absolute maximum rating for this pin), the internal low dropout regulator in the LTC1871X is redundant and the INTV<sub>CC</sub> pin can be shorted directly to the V<sub>IN</sub> pin. With the INTV<sub>CC</sub> pin shorted to V<sub>IN</sub>, however, the divider that programs the regulated INTV<sub>CC</sub> voltage will draw 10μA of current from the input supply, even in shutdown mode. For applications that require the lowest shutdown mode input supply current, do not connect the INTV<sub>CC</sub> pin to V<sub>IN</sub>. Regardless of whether the INTV<sub>CC</sub> pin is shorted to V<sub>IN</sub> or not, **it is always necessary to have the driver circuitry bypassed with a 4.7μF tantalum or low ESR ceramic capacitor to ground immediately adjacent to the INTV<sub>CC</sub> and GND pins.**

In an actual application, most of the IC supply current is used to drive the gate capacitance of the power MOSFET. As a result, high input voltage applications in which a large power MOSFET is being driven at high frequencies can cause the LTC1871X to exceed its maximum junc-

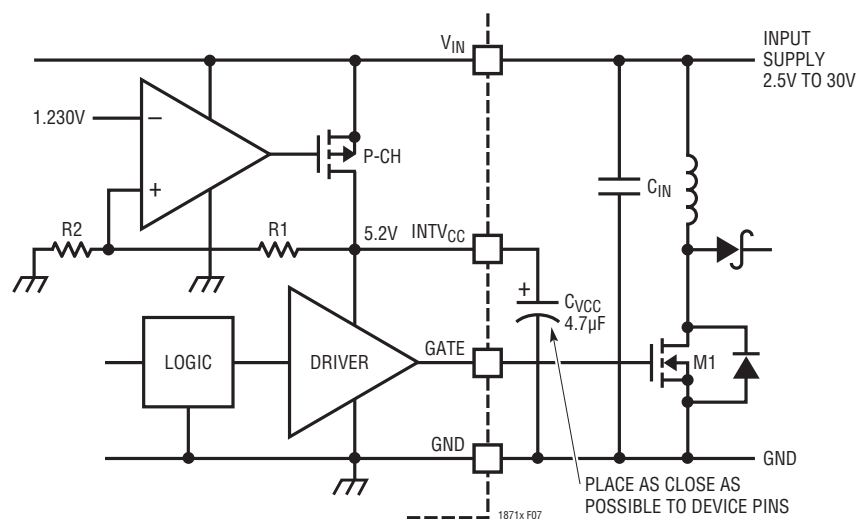

Figure 7. Bypassing the LDO Regulator and Gate Driver Supply

1871xf

## APPLICATIONS INFORMATION

tion temperature rating. The junction temperature can be estimated using the following equations:

$$I_{Q(TOT)} \approx I_Q + f \cdot Q_G$$

$$P_{IC} = V_{IN} \cdot (I_Q + f \cdot Q_G)$$

$$T_J = T_A + P_{IC} \cdot R_{TH(JA)}$$

The total quiescent current  $I_{Q(TOT)}$  consists of the static supply current ( $I_Q$ ) and the current required to charge and discharge the gate of the power MOSFET. The 10-pin MSOP package has a thermal resistance of  $R_{TH(JA)} = 120^\circ\text{C/W}$ .

As an example, consider a power supply with  $V_{IN} = 5\text{V}$  and  $V_O = 12\text{V}$  at  $I_O = 1\text{A}$ . The switching frequency is  $500\text{kHz}$ , and the maximum ambient temperature is  $70^\circ\text{C}$ . The power MOSFET chosen is the IRF7805, which has a maximum  $R_{DS(ON)}$  of  $11\text{m}\Omega$  (at room temperature) and a maximum total gate charge of  $37\text{nC}$  (the temperature coefficient of the gate charge is low).

$$I_{Q(TOT)} = 600\mu\text{A} + 37\text{nC} \cdot 500\text{kHz} = 19.1\text{mA}$$

$$P_{IC} = 5\text{V} \cdot 19.1\text{mA} = 95\text{mW}$$

$$T_J = 70^\circ\text{C} + 120^\circ\text{C/W} \cdot 95\text{mW} = 81.4^\circ\text{C}$$

This demonstrates how significant the gate charge current can be when compared to the static quiescent current in the IC.

To prevent the maximum junction temperature from being exceeded, the input supply current must be checked when operating in a continuous mode at high  $V_{IN}$ . A tradeoff between the operating frequency and the size of the power MOSFET may need to be made in order to maintain a reliable IC junction temperature. Prior to lowering the operating frequency, however, be sure to check with power MOSFET manufacturers for their latest-and-greatest low  $Q_G$ , low  $R_{DS(ON)}$  devices. Power MOSFET manufacturing technologies are continually improving, with newer and better performance devices being introduced almost yearly.

### Output Voltage Programming

The output voltage is set by a resistor divider according to the following formula:

$$V_O = 1.230\text{V} \cdot \left(1 + \frac{R_2}{R_1}\right)$$

The external resistor divider is connected to the output as shown in Figure 1, allowing remote voltage sensing. The resistors  $R_1$  and  $R_2$  are typically chosen so that the error caused by the current flowing into the FB pin during normal operation is less than 1% (this translates to a maximum value of  $R_1$  of about  $250\text{k}$ ).

### Programming Turn-On and Turn-Off Thresholds with the RUN Pin

The LTC1871X contains an independent, micropower voltage reference and comparator detection circuit that remains active even when the device is shut down, as shown in Figure 8. This allows users to accurately program an input voltage at which the converter will turn on and off. The falling threshold voltage on the RUN pin is equal to the internal reference voltage of  $1.248\text{V}$ . The comparator has  $100\text{mV}$  of hysteresis to increase noise immunity.

The turn-on and turn-off input voltage thresholds are programmed using a resistor divider according to the following formulas:

$$V_{IN(OFF)} = 1.248\text{V} \cdot \left(1 + \frac{R_2}{R_1}\right)$$

$$V_{IN(ON)} = 1.348\text{V} \cdot \left(1 + \frac{R_2}{R_1}\right)$$

The resistor  $R_1$  is typically chosen to be less than  $1\text{M}$ .

**For applications where the RUN pin is only to be used as a logic input, the user should be aware of the 7V Absolute Maximum Rating for this pin!** The RUN pin can be connected to the input voltage through an external  $1\text{M}$  resistor, as shown in Figure 8c, for “always on” operation.

### Application Circuits

A basic LTC1871X application circuit is shown in Figure 1. The circuit in Figure 1 was tested at  $175^\circ\text{C}$  to verify circuit operation. External component selection is driven by the characteristics of the load and the input supply. The first topology to be analyzed will be the boost converter, followed by SEPIC (single ended primary inductance converter).

## APPLICATIONS INFORMATION

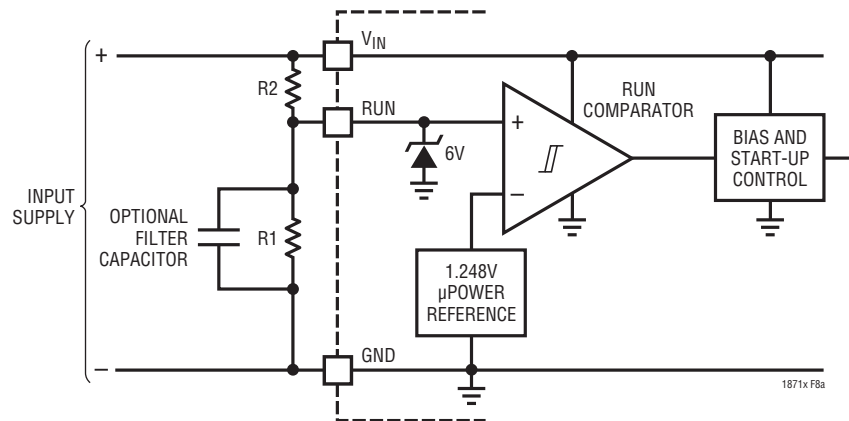

Figure 8a. Programming the Turn-On and Turn-Off Thresholds Using the RUN Pin

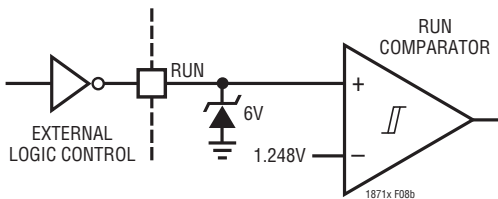

Figure 8b. On/Off Control Using External Logic

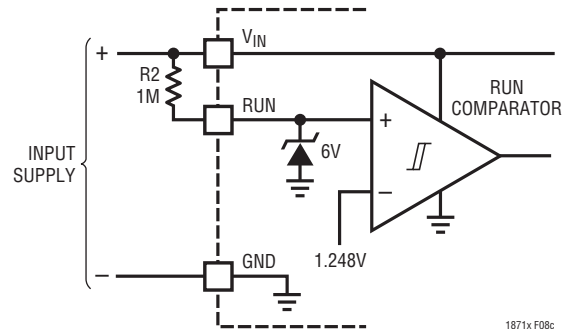

Figure 8c. External Pull-Up Resistor On RUN Pin for “Always On” Operation

### Boost Converter: Duty Cycle Considerations

For a boost converter operating in a continuous conduction mode (CCM), the duty cycle of the main switch is:

$$D = \left( \frac{V_O + V_D - V_{IN}}{V_O + V_D} \right)$$

where  $V_D$  is the forward voltage of the boost diode. For converters where the input voltage is close to the output voltage, the duty cycle is low and for converters that develop a high output voltage from a low voltage input supply, the duty cycle is high. The maximum output voltage for a boost converter operating in CCM is:

$$V_{O(MAX)} = \frac{V_{IN(MIN)}}{(1 - D_{MAX})} - V_D$$

The maximum duty cycle capability of the LTC1871X is typically 92%. This allows the user to obtain high output voltages from low input supply voltages.

### Boost Converter: The Peak and Average Input Currents

The control circuit in the LTC1871X is measuring the input current (either by using the  $R_{DS(ON)}$  of the power MOSFET or by using a sense resistor in the MOSFET source), so the output current needs to be reflected back to the input in order to dimension the power MOSFET properly. Based on the fact that, ideally, the output power is equal to the input power, the maximum average input current is:

$$I_{IN(MAX)} = \frac{I_{O(MAX)}}{1 - D_{MAX}}$$

The peak input current is:

$$I_{IN(PEAK)} = \left( 1 + \frac{\chi}{2} \right) \cdot \frac{I_{O(MAX)}}{1 - D_{MAX}}$$

The maximum duty cycle,  $D_{MAX}$ , should be calculated at minimum  $V_{IN}$ .

## APPLICATIONS INFORMATION

### Boost Converter: Ripple Current $\Delta I_L$ and the 'X' Factor

The constant 'X' in the equation above represents the percentage peak-to-peak ripple current in the inductor, relative to its maximum value. For example, if 30% ripple current is chosen, then  $X = 0.30$ , and the peak current is 15% greater than the average.

For a current mode boost regulator operating in CCM, slope compensation must be added for duty cycles above 50% in order to avoid subharmonic oscillation. For the LTC1871X, this ramp compensation is internal. Having an internally fixed ramp compensation waveform, however, does place some constraints on the value of the inductor and the operating frequency. If too large an inductor is used, the resulting current ramp ( $\Delta I_L$ ) will be small relative to the internal ramp compensation (at duty cycles above 50%), and the converter operation will approach voltage mode (ramp compensation reduces the gain of the current loop). If too small an inductor is used, but the converter is still operating in CCM (near critical conduction mode), the internal ramp compensation may be inadequate to prevent subharmonic oscillation. To ensure good current mode gain and avoid subharmonic oscillation, it is recommended that the ripple current in the inductor fall in the range of 20% to 40% of the maximum average current. For example, if the maximum average input current is 1A, choose a  $\Delta I_L$  between 0.2A and 0.4A, and a value 'X' between 0.2 and 0.4.

### Boost Converter: Inductor Selection

Given an operating input voltage range, and having chosen the operating frequency and ripple current in the inductor, the inductor value can be determined using the following equation:

$$L = \frac{V_{IN(MIN)}}{\Delta I_L \cdot f} \cdot D_{MAX}$$

where:

$$\Delta I_L = X \cdot \frac{I_{O(MAX)}}{1 - D_{MAX}}$$

Remember that boost converters are **not** short-circuit protected. Under a shorted output condition, the inductor

current is limited only by the input supply capability. For applications requiring a step-up converter that is short-circuit protected, please refer to the applications section covering SEPIC converters.

The minimum required saturation current of the inductor can be expressed as a function of the duty cycle and the load current, as follows:

$$I_{L(SAT)} \geq \left(1 + \frac{X}{2}\right) \cdot \frac{I_{O(MAX)}}{1 - D_{MAX}}$$

The saturation current rating for the inductor should be checked at the minimum input voltage (which results in the highest inductor current) and maximum output current.

### Boost Converter: Operating in Discontinuous Mode

Discontinuous mode operation occurs when the load current is low enough to allow the inductor current to run out during the off-time of the switch, as shown in Figure 9. Once the inductor current is near zero, the switch and diode capacitances resonate with the inductance to form damped ringing at 1MHz to 10MHz. If the off-time is long enough, the drain voltage will settle to the input voltage.

Depending on the input voltage and the residual energy in the inductor, this ringing can cause the drain of the power MOSFET to go below ground where it is clamped by the body diode. This ringing is not harmful to the IC and it has not been shown to contribute significantly to EMI. Any attempt to damp it with a snubber will degrade the efficiency.

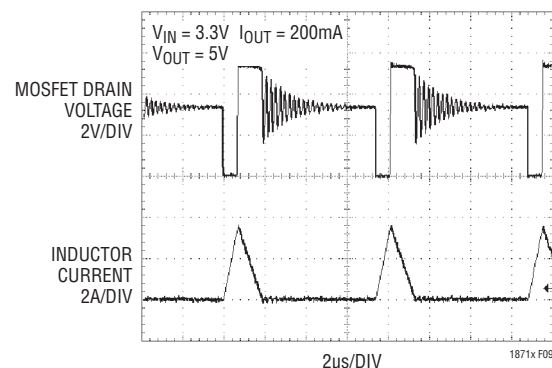

Figure 9. Discontinuous Mode Waveforms

## APPLICATIONS INFORMATION

### Boost Converter: Inductor Core Selection

Once the value for L is known, the type of inductor must be selected. High efficiency converters generally cannot afford the core loss found in low cost powdered iron cores, forcing the use of more expensive ferrite, molypermalloy or Kool M $\mu$ ® cores. Actual core loss is independent of core size for a fixed inductor value, but is very dependent on the inductance selected. As inductance increases, core losses go down. Unfortunately, increased inductance requires more turns of wire and therefore, copper losses will increase. Generally, there is a tradeoff between core losses and copper losses that needs to be balanced.

Ferrite designs have very low core losses and are preferred at high switching frequencies, so design goals can concentrate on copper losses and preventing saturation. Ferrite core material saturates “hard,” meaning that the inductance collapses rapidly when the peak design current is exceeded. This results in an abrupt increase in inductor ripple current and consequently, output voltage ripple. **Do not allow the core to saturate!**

Molypermalloy (from Magnetics, Inc.) is a very good, low cost core material for toroids, but is more expensive than ferrite. A reasonable compromise from the same manufacturer is Kool M $\mu$ .

### Boost Converter: Power MOSFET Selection

The power MOSFET serves two purposes in the LTC1871X: it represents the main switching element in the power path, and its  $R_{DS(ON)}$  represents the current sensing element for the control loop. Important parameters for the power MOSFET include the drain-to-source breakdown voltage ( $BV_{DSS}$ ), the threshold voltage ( $V_{GS(TH)}$ ), the on-resistance ( $R_{DS(ON)}$ ) versus gate-to-source voltage, the gate-to-source and gate-to-drain charges ( $Q_{GS}$  and  $Q_{GD}$ , respectively), the maximum drain current ( $I_{D(MAX)}$ ) and the MOSFET’s thermal resistances ( $R_{TH(JC)}$  and  $R_{TH(JA)}$ ).

The gate drive voltage is set by the 5.2V  $INTV_{CC}$  low drop regulator. Consequently, logic-level threshold MOSFETs should be used in most LTC1871X applications. If low input voltage operation is expected (e.g., supplying power

from a lithium-ion battery or a 3.3V logic supply), then sublogic-level threshold MOSFETs should be used.

Pay close attention to the  $BV_{DSS}$  specifications for the MOSFETs relative to the maximum actual switch voltage in the application. Many logic-level devices are limited to 30V or less, and the switch node can ring during the turn-off of the MOSFET due to layout parasitics. Check the switching waveforms of the MOSFET directly across the drain and source terminals using the actual PC board layout (not just on a lab breadboard!) for excessive ringing.

During the switch on-time, the control circuit limits the maximum voltage drop across the power MOSFET to about 150mV (at low duty cycle). The peak inductor current is therefore limited to  $150\text{mV}/R_{DS(ON)}$ . The relationship between the maximum load current, duty cycle and the  $R_{DS(ON)}$  of the power MOSFET is:

$$R_{DS(ON)} \leq V_{SENSE(MAX)} \cdot \frac{1 - D_{MAX}}{\left(1 + \frac{\chi}{2}\right) \cdot I_{O(MAX)} \cdot \rho_T}$$

The  $V_{SENSE(MAX)}$  term is typically 150mV at low duty cycle, and is reduced to about 100mV at a duty cycle of 92% due to slope compensation, as shown in Figure 10. The  $\rho_T$  term accounts for the temperature coefficient of the  $R_{DS(ON)}$  of the MOSFET, which is typically 0.4%/°C.

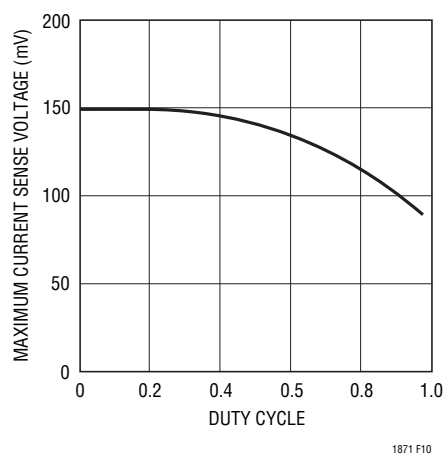

Figure 10. Maximum SENSE Threshold Voltage vs Duty Cycle

## APPLICATIONS INFORMATION

Another method of choosing which power MOSFET to use is to check what the maximum output current is for a given  $R_{DS(ON)}$ , since MOSFET on-resistances are available in discrete values.

$$I_{O(MAX)} = V_{SENSE(MAX)} \cdot \frac{1 - D_{MAX}}{\left(1 + \frac{\chi}{2}\right) \cdot R_{DS(ON)} \cdot \rho_T}$$

It is worth noting that the  $1 - D_{MAX}$  relationship between  $I_{O(MAX)}$  and  $R_{DS(ON)}$  can cause boost converters with a wide input range to experience a dramatic range of maximum input and output current. This should be taken into consideration in applications where it is important to limit the maximum current drawn from the input supply.

### Calculating Power MOSFET Switching and Conduction Losses and Junction Temperatures

In order to calculate the junction temperature of the power MOSFET, the power dissipated by the device must be known. This power dissipation is a function of the duty cycle, the load current and the junction temperature itself (due to the positive temperature coefficient of its  $R_{DS(ON)}$ ). As a result, some iterative calculation is normally required to determine a reasonably accurate value. Since the controller is using the MOSFET as both a switching and a sensing element, care should be taken to ensure that the converter is capable of delivering the required load current over all operating conditions (line voltage and temperature), and for the worst-case specifications for  $V_{SENSE(MAX)}$  and the  $R_{DS(ON)}$  of the MOSFET listed in the manufacturer's data sheet.

The power dissipated by the MOSFET in a boost converter is:

$$P_{FET} = \left(\frac{I_{O(MAX)}}{1 - D_{MAX}}\right)^2 \cdot R_{DS(ON)} \cdot D_{MAX} \cdot \rho_T + k \cdot V_0^{1.85} \cdot \frac{I_{O(MAX)}}{(1 - D_{MAX})} \cdot C_{RSS} \cdot f$$

The first term in the equation above represents the  $I^2R$  losses in the device, and the second term, the switching

losses. The constant,  $k = 1.7$ , is an empirical factor inversely related to the gate drive current and has the dimension of 1/current.

From a known power dissipated in the power MOSFET, its junction temperature can be obtained using the following formula:

$$T_J = T_A + P_{FET} \cdot R_{TH(JA)}$$

The  $R_{TH(JA)}$  to be used in this equation normally includes the  $R_{TH(JC)}$  for the device plus the thermal resistance from the case to the ambient temperature ( $R_{TH(CA)}$ ). This value of  $T_J$  can then be compared to the original, assumed value used in the iterative calculation process.

### Boost Converter: Output Diode Selection

To maximize efficiency, a fast switching diode with low forward drop and low reverse leakage is desired. The output diode in a boost converter conducts current during the switch off-time. The peak reverse voltage that the diode must withstand is equal to the regulator output voltage. The average forward current in normal operation is equal to the output current, and the peak current is equal to the peak inductor current.

$$I_{D(PEAK)} = I_{L(PEAK)} = \left(1 + \frac{\chi}{2}\right) \cdot \frac{I_{O(MAX)}}{1 - D_{MAX}}$$

The power dissipated by the diode is:

$$P_D = I_{O(MAX)} \cdot V_D$$

and the diode junction temperature is:

$$T_J = T_A + P_D \cdot R_{TH(JA)}$$

The  $R_{TH(JA)}$  to be used in this equation normally includes the  $R_{TH(JC)}$  for the device plus the thermal resistance from the board to the ambient temperature in the enclosure.

Remember to keep the diode lead lengths short and to observe proper switch-node layout (see Board Layout Checklist) to avoid excessive ringing and increased dissipation.



## APPLICATIONS INFORMATION

### Boost Converter: Output Capacitor Selection

Contributions of ESR (equivalent series resistance), ESL (equivalent series inductance) and the bulk capacitance must be considered when choosing the correct component for a given output ripple voltage. The effects of these three parameters (ESR, ESL and bulk C) on the output voltage ripple waveform are illustrated in Figure 11e for a typical boost converter.

The choice of component(s) begins with the maximum acceptable ripple voltage (expressed as a percentage of the output voltage), and how this ripple should be divided between the ESR step and the charging/discharging  $\Delta V$ . For the purpose of simplicity we will choose 2% for the maximum output ripple, to be divided equally between the ESR step and the charging/discharging  $\Delta V$ . This percentage ripple will change, depending on the requirements of the application, and the equations provided below can easily be modified.

For a 1% contribution to the total ripple voltage, the ESR of the output capacitor can be determined using the following equation:

$$ESR_{COUT} \leq \frac{0.01 \cdot V_O}{I_{IN(PEAK)}}$$

where:

$$I_{IN(PEAK)} = \left(1 + \frac{\chi}{2}\right) \cdot \frac{I_{O(MAX)}}{1 - D_{MAX}}$$

For the bulk C component, which also contributes 1% to the total ripple:

$$C_{OUT} \geq \frac{I_{O(MAX)}}{0.01 \cdot V_O \cdot f}$$

For many designs it is possible to choose a single capacitor type that satisfies both the ESR and bulk C requirements for the design. In certain demanding applications, however, the ripple voltage can be improved significantly by connecting two or more types of capacitors in parallel. For example, using a low ESR ceramic capacitor can minimize

the ESR step, while an electrolytic capacitor can be used to supply the required bulk C.

Once the output capacitor ESR and bulk capacitance have been determined, the overall ripple voltage waveform should be verified on a dedicated PC board (see Board Layout section for more information on component placement). Lab breadboards generally suffer from excessive series inductance (due to inter-component wiring), and these parasitics can make the switching waveforms look significantly worse than they would be on a properly designed PC board.

The output capacitor in a boost regulator experiences high RMS ripple currents, as shown in Figure 11. The RMS output capacitor ripple current is:

$$I_{RMS(COUT)} \approx I_{O(MAX)} \cdot \sqrt{\frac{V_O - V_{IN(MIN)}}{V_{IN(MIN)}}}$$

Note that the ripple current ratings from capacitor manufacturers are often based on only 2000 hours of life. This makes it advisable to further derate the capacitor or to choose a capacitor rated at a higher temperature than required. Several capacitors may also be placed in parallel to meet size or height requirements in the design.

Manufacturers such as Nichicon, United Chemicon and Sanyo should be considered for high performance through-hole capacitors. The OS-CON semiconductor dielectric capacitor available from Sanyo has the lowest product of ESR and size of any aluminum electrolytic, at a somewhat higher price.

In surface mount applications, multiple capacitors may have to be placed in parallel in order to meet the ESR or RMS current handling requirements of the application. Aluminum electrolytic and dry tantalum capacitors are both available in surface mount packages. In the case of tantalum, it is critical that the capacitors have been surge tested for use in switching power supplies. An excellent choice is AVX TPS series of surface mount tantalum. Also, ceramic capacitors are now available with extremely low ESR, ESL and high ripple current ratings.

## APPLICATIONS INFORMATION

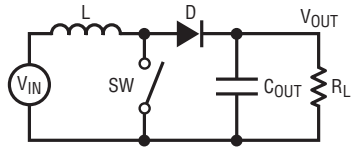

11a. Circuit Diagram

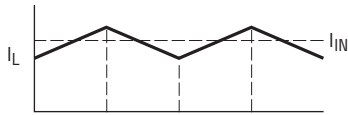

11b. Inductor and Input Currents

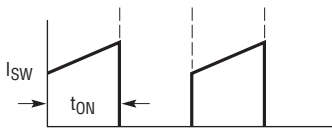

11c. Switch Current

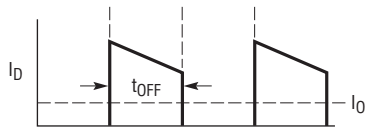

11d. Diode and Output Currents

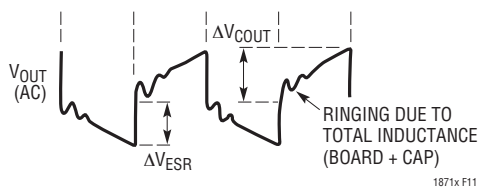

11e. Output Voltage Ripple Waveform

Figure 11. Switching Waveforms for a Boost Converter

## Boost Converter: Input Capacitor Selection

The input capacitor of a boost converter is less critical than the output capacitor, due to the fact that the inductor is in series with the input and the input current waveform is continuous (see Figure 11b). The input voltage source impedance determines the size of the input capacitor, which is typically in the range of 10 $\mu$ F to 100 $\mu$ F. A low ESR capacitor is recommended, although it is not as critical as for the output capacitor.

The RMS input capacitor ripple current for a boost converter is:

$$I_{\text{RMS(CIN)}} = 0.3 \cdot \frac{V_{\text{IN(MIN)}}}{L \cdot f} \cdot D_{\text{MAX}}$$

Please note that the input capacitor can see a very high surge current when a battery is suddenly connected to the input of the converter and solid tantalum capacitors can fail catastrophically under these conditions. **Be sure to specify surge-tested capacitors!**

## Burst Mode Operation and Considerations

The choice of MOSFET  $R_{\text{DS(ON)}}$  and inductor value also determines the load current at which the LTC1871X enters Burst Mode operation. When bursting, the controller clamps the peak inductor current to approximately:

$$I_{\text{BURST(PEAK)}} = \frac{30\text{mV}}{R_{\text{DS(ON)}}}$$

which represents about 20% of the maximum 150mV SENSE pin voltage. The corresponding average current depends upon the amount of ripple current. Lower inductor values (higher  $\Delta I_L$ ) will reduce the load current at which Burst Mode operations begins, since it is the peak current that is being clamped.

The output voltage ripple can increase during Burst Mode operation if  $\Delta I_L$  is substantially less than  $I_{\text{BURST}}$ . This can occur if the input voltage is very low or if a very large inductor is chosen. At high duty cycles, a skipped cycle causes the inductor current to quickly decay to zero. However, because  $\Delta I_L$  is small, it takes multiple cycles for the current to ramp back up to  $I_{\text{BURST(PEAK)}}$ . During this inductor charging interval, the output capacitor must supply the load current and a significant droop in the output voltage can occur. Generally, it is a good idea to choose a value of inductor  $\Delta I_L$  between 25% and 40% of  $I_{\text{IN(MAX)}}$ . The alternative is to either increase the value of the output capacitor or disable Burst Mode operation using the MODE/SYNC pin.

Burst Mode operation can be defeated by connecting the MODE/SYNC pin to a high logic-level voltage (either with a control input or by connecting this pin to INTV<sub>CC</sub>). In this mode, the burst clamp is removed, and the chip can operate at constant frequency from continuous conduction mode (CCM) at full load, down into deep discontinuous conduction mode (DCM) at light load. Prior to skipping pulses at very light load (i.e., <5% of full load), the controller will operate with a minimum switch on-time in DCM.

1871xf

## APPLICATIONS INFORMATION

**Table 1. Recommended Component Manufacturers**

VENDOR	COMPONENTS	TELEPHONE	WEB ADDRESS
AVX	Capacitors	(207) 282-5111	avxcorp.com
BH Electronics	Inductors, Transformers	(952) 894-9590	bhelectronics.com
Coilcraft	Inductors	(847) 639-6400	coilcraft.com
Coiltronics	Inductors	(407) 241-7876	coiltronics.com
Diodes, Inc	Diodes	(805) 446-4800	diodes.com
Fairchild	MOSFETs	(408) 822-2126	fairchildsemi.com
General Semiconductor	Diodes	(516) 847-3000	generalsemiconductor.com
International Rectifier	MOSFETs, Diodes	(310) 322-3331	irf.com
IRC	Sense Resistors	(361) 992-7900	irctt.com
Kemet	Tantalum Capacitors	(408) 986-0424	kemet.com
Magnetics Inc	Toroid Cores	(800) 245-3984	mag-inc.com
Microsemi	Diodes	(617) 926-0404	microsemi.com
Murata-Erie	Inductors, Capacitors	(770) 436-1300	murata.co.jp
Nichicon	Capacitors	(847) 843-7500	nichicon.com
On Semiconductor	Diodes	(602) 244-6600	onsemi.com
Panasonic	Capacitors	(714) 373-7334	panasonic.com
Sanyo	Capacitors	(619) 661-6835	sanyo.co.jp
Sumida	Inductors	(847) 956-0667	sumida.com
Taiyo Yuden	Capacitors	(408) 573-4150	t-yuden.com
TDK	Capacitors, Inductors	(562) 596-1212	component.tdk.com
Thermalloy	Heat Sinks	(972) 243-4321	aavidthermalloy.com
Token	Capacitors	(408) 432-8020	nec-tokenamerica.com
Toko	Inductors	(847) 699-3430	tokoam.com
United Chemicon	Capacitors	(847) 696-2000	chemi-com.com
Vishay/Dale	Resistors	(605) 665-9301	vishay.com
Vishay/Siliconix	MOSFETs	(800) 554-5565	vishay.com
Vishay/Sprague	Capacitors	(207) 324-4140	vishay.com
Zetex	Small-Signal Discrettes	(631) 543-7100	zetex.com

Pulse skipping prevents a loss of control of the output at very light loads and reduces output voltage ripple.

### Efficiency Considerations: How Much Does $V_{DS}$ Sensing Help?

The efficiency of a switching regulator is equal to the output power divided by the input power ( $\times 100\%$ ). Percent efficiency can be expressed as:

$$\% \text{ Efficiency} = 100\% - (L1 + L2 + L3 + \dots),$$

where L1, L2, etc. are the individual loss components as a percentage of the input power. It is often useful to analyze individual losses to determine what is limiting the efficiency

and which change would produce the most improvement. Although all dissipative elements in the circuit produce losses, four main sources usually account for the majority of the losses in LTC1871X application circuits:

1. The supply current into  $V_{IN}$ . The  $V_{IN}$  current is the sum of the DC supply current  $I_Q$  (given in the Electrical Characteristics) and the MOSFET driver and control currents. The DC supply current into the  $V_{IN}$  pin is typically about  $550\mu A$  and represents a small power loss (much less than 1%) that increases with  $V_{IN}$ . The driver current results from switching the gate capacitance of the power MOSFET; this current is typically much larger than the DC current. Each time the MOSFET is switched on and

## APPLICATIONS INFORMATION

then off, a packet of gate charge  $Q_G$  is transferred from  $INTV_{CC}$  to ground. The resulting  $dQ/dt$  is a current that must be supplied to the  $INTV_{CC}$  capacitor through the  $V_{IN}$  pin by an external supply. If the IC is operating in CCM:

$$I_{Q(TOT)} \approx I_Q = f \cdot Q_G$$

$$P_{IC} = V_{IN} \cdot (I_Q + f \cdot Q_G)$$

2. Power MOSFET switching and conduction losses. The technique of using the voltage drop across the power MOSFET to close the current feedback loop was chosen because of the increased efficiency that results from not having a sense resistor. The losses in the power MOSFET are equal to:

$$P_{FET} = \left( \frac{I_{O(MAX)}}{1-D_{MAX}} \right)^2 \cdot R_{DS(ON)} \cdot D_{MAX} \cdot \rho_T \\ + k \cdot V_0^{1.85} \cdot \frac{I_{O(MAX)}}{(1-D_{MAX})} \cdot C_{RSS} \cdot f$$

The  $I^2R$  power savings that result from not having a discrete sense resistor can be calculated almost by inspection.

$$P_{R(SENSE)} = \left( \frac{I_{O(MAX)}}{1-D_{MAX}} \right)^2 \cdot R_{SENSE} \cdot D_{MAX}$$

To understand the magnitude of the improvement with this  $V_{DS}$  sensing technique, consider the 3.3V input, 5V output power supply shown in Figure 1. The maximum load current is 7A (10A peak) and the duty cycle is 39%. Assuming a ripple current of 40%, the peak inductor current is 13.8A and the average is 11.5A. With a maximum sense voltage of about 140mV, the sense resistor value would be 10m $\Omega$ , and the power dissipated in this resistor would be 514mW at maximum output current. Assuming an efficiency of 90%, this sense resistor power dissipation represents 1.3% of the overall input power. In other words, for this application, the use of  $V_{DS}$  sensing would increase the efficiency by approximately 1.3%.

For more details regarding the various terms in these equations, please refer to the section Boost Converter: Power MOSFET Selection.

3. The losses in the inductor are simply the DC input current squared times the winding resistance. Expressing this loss as a function of the output current yields:

$$P_{R(WINDING)} = \left( \frac{I_{O(MAX)}}{1-D_{MAX}} \right)^2 \cdot R_W$$

4. Losses in the boost diode. The power dissipation in the boost diode is:

$$P_{DIODE} = I_{O(MAX)} \cdot V_D$$

The boost diode can be a major source of power loss in a boost converter. For the 3.3V input, 5V output at 7A example given above, a Schottky diode with a 0.4V forward voltage would dissipate 2.8W, which represents 7% of the input power. Diode losses can become significant at low output voltages where the forward voltage is a significant percentage of the output voltage.

5. Other losses, including  $C_{IN}$  and  $C_O$  ESR dissipation and inductor core losses, generally account for less than 2% of the total additional loss.

### Checking Transient Response

The regulator loop response can be verified by looking at the load transient response. Switching regulators generally take several cycles to respond to an instantaneous step in resistive load current. When the load step occurs,  $V_O$  immediately shifts by an amount equal to  $(\Delta I_{LOAD})(ESR)$ , and then  $C_O$  begins to charge or discharge (depending on the direction of the load step) as shown in Figure 12. The regulator feedback loop acts on the resulting error amp output signal to return  $V_O$  to its steady-state value. During this recovery time,  $V_O$  can be monitored for overshoot or ringing that would indicate a stability problem.

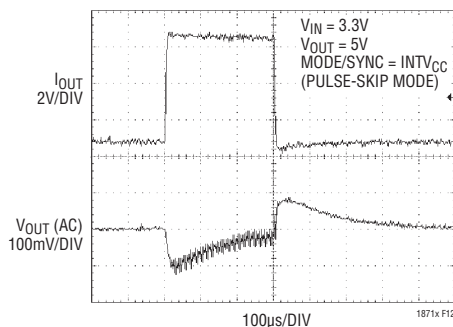

Figure 12. Load Transient Response for a 3.3V Input, 5V Output Boost Converter Application, 0.7A to 7A Step

1871xf

## APPLICATIONS INFORMATION

A second, more severe transient can occur when connecting loads with large ( $> 1\mu\text{F}$ ) supply bypass capacitors. The discharged bypass capacitors are effectively put in parallel with  $C_0$ , causing a nearly instantaneous drop in  $V_0$ . No regulator can deliver enough current to prevent this problem if the load switch resistance is low and it is driven quickly. The only solution is to limit the rise time of the switch drive in order to limit the inrush current  $di/dt$  to the load.

### Boost Converter Design Example

The design example given here will be for the circuit shown in Figure 1. The input voltage is 3.3V, and the output is 5V at a maximum load current of 7A (10A peak).

1. The duty cycle is:

$$D = \left( \frac{V_0 + V_D - V_{IN}}{V_0 + V_D} \right) = \frac{5 + 0.4 - 3.3}{5 + 0.4} = 38.9\%$$

2. Pulse-skip operation is chosen so the MODE/SYNC pin is shorted to INTV<sub>CC</sub>.

3. The operating frequency is chosen to be 300kHz to reduce the size of the inductor. From Figure 5, the resistor from the FREQ pin to ground is 80k.

4. An inductor ripple current of 40% of the maximum load current is chosen, so the peak input current (which is also the minimum saturation current) is:

$$I_{IN(PEAK)} = \left( 1 + \frac{\chi}{2} \right) \cdot \frac{I_{O(MAX)}}{1 - D_{MAX}} = 1.2 \cdot \frac{7}{1 - 0.39} = 13.8\text{A}$$

The inductor ripple current is:

$$\Delta I_L = \chi \cdot \frac{I_{O(MAX)}}{1 - D_{MAX}} = 0.4 \cdot \frac{7}{1 - 0.39} = 4.6\text{A}$$

And so the inductor value is:

$$L = \frac{V_{IN(MIN)}}{\Delta I_L \cdot f} \cdot D_{MAX} = \frac{3.3\text{V}}{4.6\text{A} \cdot 300\text{kHz}} \cdot 0.39 = 0.93\mu\text{H}$$

The component chosen is a 1 $\mu\text{H}$  inductor made by Sumida (part number CEP125-H 1ROMH) which has a saturation current of greater than 20A.

5. With the input voltage to the IC bootstrapped to the output of the power supply (5V), a logic-level MOSFET

can be used. Because the duty cycle is 39%, the maximum SENSE pin threshold voltage is reduced from its low duty cycle typical value of 150mV to approximately 140mV. Assuming a MOSFET junction temperature of 125°C, the room temperature MOSFET  $R_{DS(ON)}$  should be less than:

$$R_{DS(ON)} \leq V_{SENSE(MAX)} \cdot \frac{1 - D_{MAX}}{\left( 1 + \frac{\chi}{2} \right) \cdot I_{O(MAX)} \cdot P_T}$$

$$= 0.140\text{V} \cdot \frac{1 - 0.39}{\left( 1 + \frac{0.4}{2} \right) \cdot 7\text{A} \cdot 1.5} = 6.8\text{m}\Omega$$

The MOSFET used was the Fairchild FDS7760A, which has a maximum  $R_{DS(ON)}$  of 8m $\Omega$  at 4.5V  $V_{GS}$ , a  $BV_{DSS}$  of greater than 30V, and a gate charge of 37nC at 5V  $V_{GS}$ .

6. The diode for this design must handle a maximum DC output current of 10A and be rated for a minimum reverse voltage of  $V_{OUT}$ , or 5V. A 25A, 15V diode from On Semiconductor (MBRB2515L) was chosen for its high power dissipation capability.

7. The output capacitor usually consists of a high valued bulk C connected in parallel with a lower valued, low ESR ceramic. Based on a maximum output ripple voltage of 1%, or 50mV, the bulk C needs to be greater than:

$$C_{OUT} \geq \frac{I_{OUT(MAX)}}{0.01 \cdot V_{OUT} \cdot f}$$

$$\frac{7\text{A}}{0.01 \cdot 5\text{V} \cdot 300\text{kHz}} = 466\mu\text{F}$$

The RMS ripple current rating for this capacitor needs to exceed:

$$I_{RMS(COUT)} \geq I_{O(MAX)} \cdot \sqrt{\frac{V_0 - V_{IN(MIN)}}{V_{IN(MIN)}}}$$

$$7\text{A} \cdot \sqrt{\frac{5\text{V} - 3.3\text{V}}{3.3\text{V}}} = 5\text{A}$$

To satisfy this high RMS current demand, four 150 $\mu\text{F}$  Panasonic capacitors (EEFUEOJ151R) are required. In parallel with these bulk capacitors, two 22 $\mu\text{F}$ , low ESR (X5R) Taiyo Yuden ceramic capacitors (JMK325BJ226MM) are added for HF noise reduction.

1871xf

## APPLICATIONS INFORMATION

Check the output ripple with a single oscilloscope probe connected directly across the output capacitor terminals, where the HF switching currents flow.

8. The choice of an input capacitor for a boost converter depends on the impedance of the source supply and the amount of input ripple the converter will safely tolerate. For this particular design and lab setup a 100 $\mu$ F Sanyo Poscap (6TPC 100M), in parallel with two 22 $\mu$ F Taiyo Yuden ceramic capacitors (JMK325BJ226MM) is required (the input and return lead lengths are kept to a few inches, but the peak input current is close to 20A!). As with the output node, check the input ripple with a single oscilloscope probe connected across the input capacitor terminals.

### PC Board Layout Checklist

1. In order to minimize switching noise and improve output load regulation, the GND pin of the LTC1871X should be connected directly to 1) the negative terminal of the INTV<sub>CC</sub> decoupling capacitor, 2) the negative terminal of the output decoupling capacitors, 3) the source of the power MOSFET or the bottom terminal of the sense resistor, 4) the negative terminal of the input capacitor and 5) at least one via to the ground plane immediately adjacent to Pin 6. The ground trace on the top layer of the PC board should be as wide and short as possible to minimize series resistance and inductance.
2. Beware of ground loops in multiple layer PC boards. Try to maintain one central ground node on the board and use the input capacitor to avoid excess input ripple for high output current power supplies. If the ground plane is to be used for high DC currents, choose a path away from the small-signal components.
3. Place the C<sub>VCC</sub> capacitor immediately adjacent to the INTV<sub>CC</sub> and GND pins on the IC package. This capacitor carries high di/dt MOSFET gate drive currents. A low ESR and ESL 4.7 $\mu$ F ceramic capacitor works well here.
4. The high di/dt loop from the bottom terminal of the output capacitor, through the power MOSFET, through the boost diode and back through the output capacitors should be kept as tight as possible to reduce inductive ringing. Excess inductance can cause increased stress on the power MOSFET and increase HF noise on the output. If low ESR ceramic capacitors are used on the output to reduce output noise, place these capacitors close to the boost diode in order to keep the series inductance to a minimum.
5. Check the stress on the power MOSFET by measuring its drain-to-source voltage directly across the device terminals (reference the ground of a single scope probe directly to the source pad on the PC board). Beware of inductive ringing which can exceed the maximum specified voltage rating of the MOSFET. If this ringing cannot be avoided and exceeds the maximum rating of the device, either choose a higher voltage device or specify an avalanche-rated power MOSFET. Not all MOSFETs are created equal (some are more equal than others).
6. Place the small-signal components away from high frequency switching nodes. In the layout shown in Figure 13, all of the small-signal components have been placed on one side of the IC and all of the power components have been placed on the other. This also allows the use of a pseudo-Kelvin connection for the signal ground, where high di/dt gate driver currents flow out of the IC ground pin in one direction (to the bottom plate of the INTV<sub>CC</sub> decoupling capacitor) and small-signal currents flow in the other direction.
7. If a sense resistor is used in the source of the power MOSFET, minimize the capacitance between the SENSE pin trace and any high frequency switching nodes. The LTC1871X contains an internal leading edge blanking time of approximately 180ns, which should be adequate for most applications.
8. For optimum load regulation and true remote sensing, the top of the output resistor divider should connect independently to the top of the output capacitor (Kelvin connection), staying away from any high dV/dt traces. Place the divider resistors near the LTC1871X in order to keep the high impedance FB node short.
9. For applications with multiple switching power converters connected to the same input supply, make sure that the input filter capacitor for the LTC1871X is not shared with other converters. AC input current

# APPLICATIONS INFORMATION

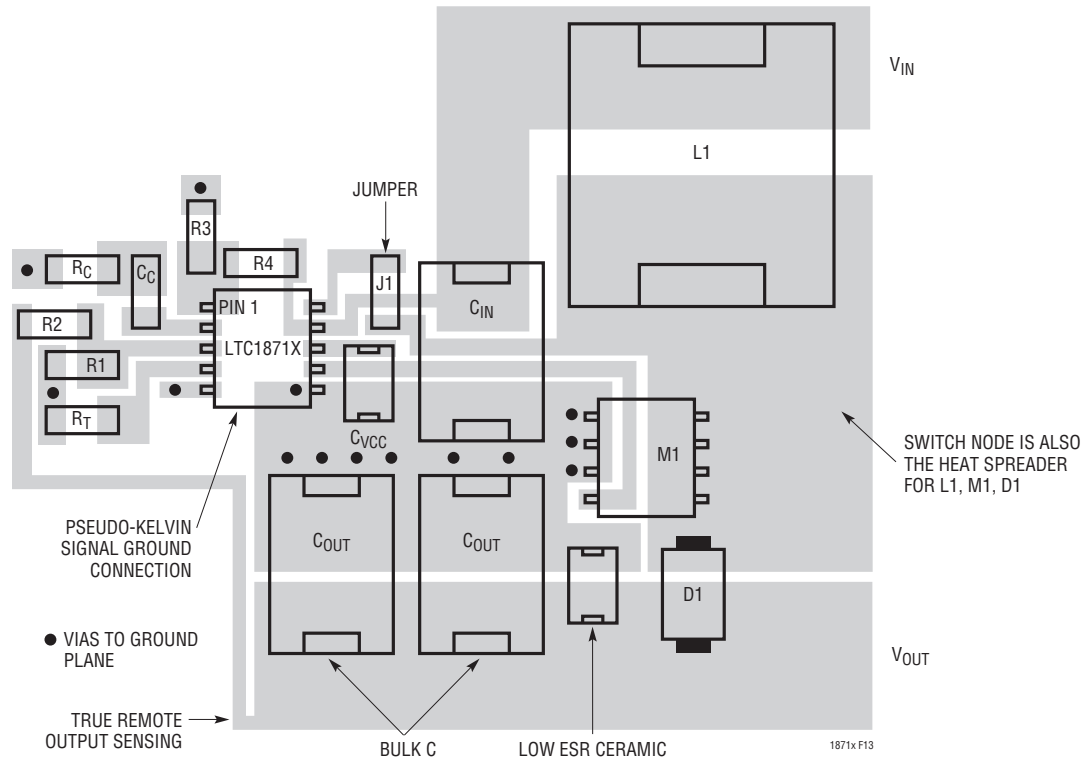

Figure 13. LTC1871X Boost Converter Suggested Layout

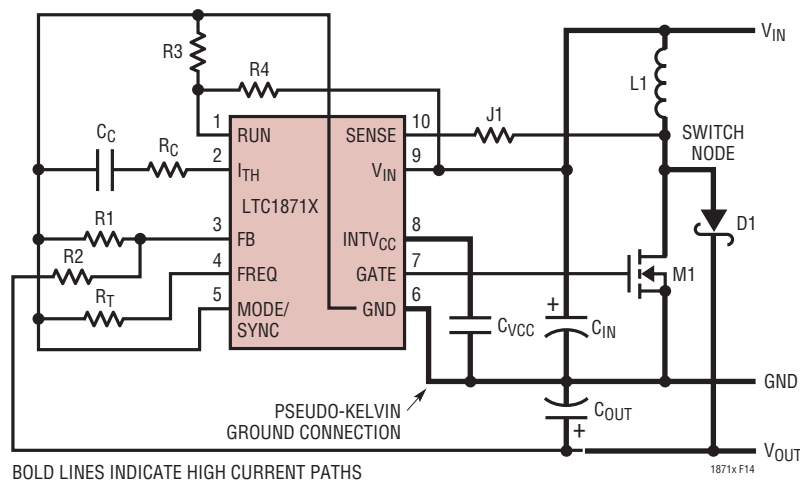

Figure 14. LTC1871X Boost Converter Layout Diagram

## APPLICATIONS INFORMATION

from another converter could cause substantial input voltage ripple, and this could interfere with the operation of the LTC1871X. A few inches of PC trace or wire ( $L \approx 100\text{nH}$ ) between the  $C_{\text{IN}}$  of the LTC1871X and the actual source  $V_{\text{IN}}$  should be sufficient to prevent current sharing problems.

### SEPIC Converter Applications

The LTC1871X is also well suited to SEPIC (single-ended primary inductance converter) converter applications. The SEPIC converter shown in Figure 15 uses two inductors. The advantage of the SEPIC converter is the input voltage may be higher or lower than the output voltage, and the output is short-circuit protected.

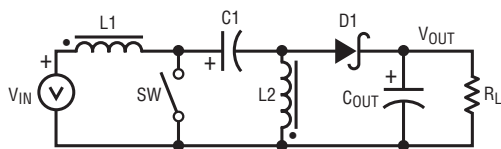

15a. SEPIC Topology

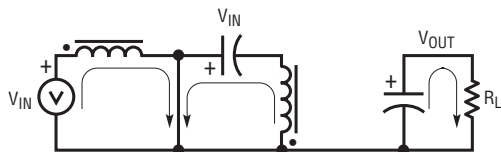

15b. Current Flow During Switch On-Time

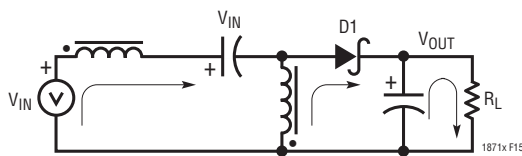

15c. Current Flow During Switch Off-Time

Figures 15. SEPIC Topology and Current Flow

The first inductor,  $L1$ , together with the main switch, resembles a boost converter. The second inductor,  $L2$ , together with the output diode  $D1$ , resembles a flyback or buck-boost converter. The two inductors  $L1$  and  $L2$  can be independent but can also be wound on the same core since identical voltages are applied to  $L1$  and  $L2$  throughout the switching cycle. By making  $L1 = L2$  and winding them on the same core the input ripple is reduced along with cost

and size. All of the SEPIC applications information that follows assumes  $L1 = L2 = L$ .

### SEPIC Converter: Duty Cycle Considerations

For a SEPIC converter operating in a continuous conduction mode (CCM), the duty cycle of the main switch is:

$$D = \left( \frac{V_O + V_D}{V_{\text{IN}} + V_O + V_D} \right)$$

where  $V_D$  is the forward voltage of the diode. For converters where the input voltage is close to the output voltage the duty cycle is near 50%.

The maximum output voltage for a SEPIC converter is:

$$V_{O(\text{MAX})} = (V_{\text{IN}} + V_D) \frac{D_{\text{MAX}}}{1 - D_{\text{MAX}}} - V_D \frac{1}{1 - D_{\text{MAX}}}$$

The maximum duty cycle of the LTC1871X is typically 92%.

### SEPIC Converter: The Peak and Average Input Currents

The control circuit in the LTC1871X is measuring the input current (either using the  $R_{\text{DS(ON)}}$  of the power MOSFET or by means of a sense resistor in the MOSFET source), so the output current needs to be reflected back to the input in order to dimension the power MOSFET properly. Based on the fact that, ideally, the output power is equal to the input power, the maximum input current for a SEPIC converter is:

$$I_{\text{IN}(\text{MAX})} = I_{\text{O}(\text{MAX})} \cdot \frac{D_{\text{MAX}}}{1 - D_{\text{MAX}}}$$

The peak input current is:

$$I_{\text{IN}(\text{PEAK})} = \left( 1 + \frac{\chi}{2} \right) \cdot I_{\text{O}(\text{MAX})} \cdot \frac{D_{\text{MAX}}}{1 - D_{\text{MAX}}}$$

The maximum duty cycle,  $D_{\text{MAX}}$ , should be calculated at minimum  $V_{\text{IN}}$ .

The constant ' $\chi$ ' represents the fraction of ripple current in the inductor relative to its maximum value. For example, if 30% ripple current is chosen, then  $\chi = 0.30$  and the peak current is 15% greater than the average.



## APPLICATIONS INFORMATION

It is worth noting here that SEPIC converters that operate at high duty cycles (i.e., that develop a high output voltage from a low input voltage) can have very high input currents, relative to the output current. Be sure to check that the maximum load current will not overload the input supply.

### SEPIC Converter: Inductor Selection

For most SEPIC applications the equal inductor values will fall in the range of 10 $\mu$ H to 100 $\mu$ H. Higher values will reduce the input ripple voltage and reduce the core loss. Lower inductor values are chosen to reduce physical size and improve transient response.

Like the boost converter, the input current of the SEPIC converter is calculated at full load current and minimum input voltage. The peak inductor current can be significantly higher than the output current, especially with smaller inductors and lighter loads. The following formulas assume CCM operation and calculate the maximum peak inductor currents at minimum  $V_{IN}$ :

$$I_{L1(PEAK)} = \left(1 + \frac{\chi}{2}\right) \cdot I_{O(MAX)} \cdot \frac{V_O + V_D}{V_{IN(MIN)}}$$

$$I_{L2(PEAK)} = \left(1 + \frac{\chi}{2}\right) \cdot I_{O(MAX)} \cdot \frac{V_{IN(MIN)} + V_D}{V_{IN(MIN)}}$$

The ripple current in the inductor is typically 20% to 40% (i.e., a range of ' $\chi$ ' from 0.20 to 0.40) of the maximum average input current occurring at  $V_{IN(MIN)}$  and  $I_{O(MAX)}$  and  $\Delta I_{L1} = \Delta I_{L2}$ . Expressing this ripple current as a function of the output current results in the following equations for calculating the inductor value:

$$L = \frac{V_{IN(MIN)}}{\Delta I_L \cdot f} \cdot D_{MAX}$$

where:

$$\Delta I_L = \chi \cdot I_{O(MAX)} \cdot \frac{D_{MAX}}{1 - D_{MAX}}$$

By making  $L1 = L2$  and winding them on the same core, the value of inductance in the equation above is replaced by  $2L$  due to mutual inductance. Doing this maintains the same ripple current and energy storage in the inductors. For

example, a Coiltronix CTX10-4 is a 10 $\mu$ H inductor with two windings. With the windings in parallel, 10 $\mu$ H inductance is obtained with a current rating of 4A (the number of turns hasn't changed, but the wire diameter has doubled). Splitting the two windings creates two 10 $\mu$ H inductors with a current rating of 2A each. Therefore, substituting  $2L$  yields the following equation for coupled inductors:

$$L1=L2 = \frac{V_{IN(MIN)}}{2 \cdot \Delta I_L \cdot f} \cdot D_{MAX}$$

Specify the maximum inductor current to safely handle  $I_{L(PK)}$  specified in the equation above. The saturation current rating for the inductor should be checked at the minimum input voltage (which results in the highest inductor current) and maximum output current.

### SEPIC Converter: Power MOSFET Selection

The power MOSFET serves two purposes in the LTC1871X: it represents the main switching element in the power path, and its  $R_{DS(ON)}$  represents the current sensing element for the control loop. Important parameters for the power MOSFET include the drain-to-source breakdown voltage ( $BV_{DSS}$ ), the threshold voltage ( $V_{GS(TH)}$ ), the on-resistance ( $R_{DS(ON)}$ ) versus gate-to-source voltage, the gate-to-source and gate-to-drain charges ( $Q_{GS}$  and  $Q_{GD}$ , respectively), the maximum drain current ( $I_{D(MAX)}$ ) and the MOSFET's thermal resistances ( $R_{TH(JC)}$  and  $R_{TH(JA)}$ ).

The gate drive voltage is set by the 5.2V  $INTV_{CC}$  low dropout regulator. Consequently, logic-level threshold MOSFETs should be used in most LTC1871X applications. If low input voltage operation is expected (e.g., supplying power from a lithium-ion battery), then sublogic-level threshold MOSFETs should be used.

The maximum voltage that the MOSFET switch must sustain during the off-time in a SEPIC converter is equal to the sum of the input and output voltages ( $V_O + V_{IN}$ ). As a result, careful attention must be paid to the  $BV_{DSS}$  specifications for the MOSFETs relative to the maximum actual switch voltage in the application. Many logic-level devices are limited to 30V or less. Check the switching waveforms directly across the drain and source terminals of the power MOSFET to ensure the  $V_{DS}$  remains below the maximum rating for the device.

## APPLICATIONS INFORMATION

During the MOSFET's on-time, the control circuit limits the maximum voltage drop across the power MOSFET to about 150mV (at low duty cycle). The peak inductor current is therefore limited to  $150\text{mV}/R_{\text{DS(ON)}}$ . The relationship between the maximum load current, duty cycle and the  $R_{\text{DS(ON)}}$  of the power MOSFET is:

$$R_{\text{DS(ON)}} \leq \frac{V_{\text{SENSE(MAX)}}}{I_{\text{O(MAX)}}} \cdot \frac{1}{\left(1 + \frac{\chi}{2}\right) \cdot \rho_{\text{T}}} \cdot \frac{1}{\left(\frac{V_{\text{O}} + V_{\text{D}}}{V_{\text{IN(MIN)}}}\right) + 1}$$

The  $V_{\text{SENSE(MAX)}}$  term is typically 150mV at low duty cycle and is reduced to about 100mV at a duty cycle of 92% due to slope compensation, as shown in Figure 8. The constant ' $\chi$ ' in the denominator represents the ripple current in the inductors relative to their maximum current. For example, if 30% ripple current is chosen, then  $\chi = 0.30$ . The  $\rho_{\text{T}}$  term accounts for the temperature coefficient of the  $R_{\text{DS(ON)}}$  of the MOSFET, which is typically 0.4%/°C. Figure 9 illustrates the variation of normalized  $R_{\text{DS(ON)}}$  over temperature for a typical power MOSFET.

Another method of choosing which power MOSFET to use is to check what the maximum output current is for a given  $R_{\text{DS(ON)}}$  since MOSFET on-resistances are available in discrete values.

$$I_{\text{O(MAX)}} \leq \frac{V_{\text{SENSE(MAX)}}}{R_{\text{DS(ON)}}} \cdot \frac{1}{\left(1 + \frac{\chi}{2}\right) \cdot \rho_{\text{T}}} \cdot \frac{1}{\left(\frac{V_{\text{O}} + V_{\text{D}}}{V_{\text{IN(MIN)}}}\right) + 1}$$

### Calculating Power MOSFET Switching and Conduction Losses and Junction Temperatures

In order to calculate the junction temperature of the power MOSFET, the power dissipated by the device must be known. This power dissipation is a function of the duty cycle, the load current and the junction temperature itself. As a result, some iterative calculation is normally required to determine a reasonably accurate value. Since the controller is using the MOSFET as both a switching and a sensing element, care should be taken to ensure that the converter is capable of delivering the required load current over all operating conditions (load, line and temperature) and for the worst-case specifications for  $V_{\text{SENSE(MAX)}}$  and the  $R_{\text{DS(ON)}}$  of the MOSFET listed in the manufacturer's data sheet.

The power dissipated by the MOSFET in a SEPIC converter is:

$$P_{\text{FET}} = \left( I_{\text{O(MAX)}} \cdot \frac{D_{\text{MAX}}}{1 - D_{\text{MAX}}} \right)^2 \cdot R_{\text{DS(ON)}} \cdot D_{\text{MAX}} \cdot \rho_{\text{T}} + k \cdot \left( V_{\text{IN(MIN)}} + V_{\text{O}} \right)^{1.85} \cdot I_{\text{O(MAX)}} \cdot \frac{D_{\text{MAX}}}{1 - D_{\text{MAX}}} \cdot C_{\text{RSS}} \cdot f$$

The first term in the equation above represents the  $I^2R$  losses in the device and the second term, the switching losses. The constant  $k = 1.7$  is an empirical factor inversely related to the gate drive current and has the dimension of 1/current.

From a known power dissipated in the power MOSFET, its junction temperature can be obtained using the following formula:

$$T_{\text{J}} = T_{\text{A}} + P_{\text{FET}} \cdot R_{\text{TH(JA)}}$$

The  $R_{\text{TH(JA)}}$  to be used in this equation normally includes the  $R_{\text{TH(JC)}}$  for the device plus the thermal resistance from the board to the ambient temperature in the enclosure. This value of  $T_{\text{J}}$  can then be used to check the original assumption for the junction temperature in the iterative calculation process.

### SEPIC Converter: Output Diode Selection

To maximize efficiency, a fast-switching diode with low forward drop and low reverse leakage is desired. The output diode in a SEPIC converter conducts current during the switch off-time. The peak reverse voltage that the diode must withstand is equal to  $V_{\text{IN(MAX)}} + V_{\text{O}}$ . The average forward current in normal operation is equal to the output current, and the peak current is equal to:

$$I_{\text{D(PEAK)}} = \left( 1 + \frac{\chi}{2} \right) \cdot I_{\text{O(MAX)}} \cdot \left( \frac{V_{\text{O}} + V_{\text{D}}}{V_{\text{IN(MIN)}}} + 1 \right)$$

The power dissipated by the diode is:

$$P_{\text{D}} = I_{\text{O(MAX)}} \cdot V_{\text{D}}$$

and the diode junction temperature is:

$$T_{\text{J}} = T_{\text{A}} + P_{\text{D}} \cdot R_{\text{TH(JA)}}$$

The  $R_{\text{TH(JA)}}$  to be used in this equation normally includes the  $R_{\text{TH(JC)}}$  for the device plus the thermal resistance from the board to the ambient temperature in the enclosure.

## APPLICATIONS INFORMATION

### SEPIC Converter: Output Capacitor Selection

Because of the improved performance of today's electrolytic, tantalum and ceramic capacitors, engineers need to consider the contributions of ESR (equivalent series resistance), ESL (equivalent series inductance) and the bulk capacitance when choosing the correct component for a given output ripple voltage. The effects of these three parameters (ESR, ESL, and bulk C) on the output voltage ripple waveform are illustrated in Figure 16 for a typical coupled-inductor SEPIC converter.

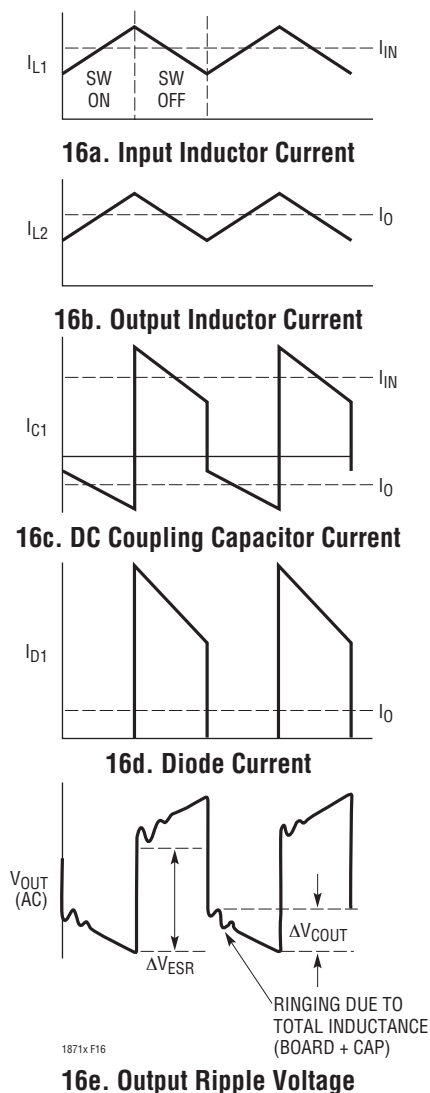

Figure 16. SEPIC Converter Switching Waveforms

The choice of component(s) begins with the maximum acceptable ripple voltage (expressed as a percentage of the output voltage), and how this ripple should be divided between the ESR step and the charging/discharging  $\Delta V$ . For the purpose of simplicity we will choose 2% for the maximum output ripple, to be divided equally between the ESR step and the charging/discharging  $\Delta V$ . This percentage ripple will change, depending on the requirements of the application, and the equations provided below can easily be modified.

For a 1% contribution to the total ripple voltage, the ESR of the output capacitor can be determined using the following equation:

$$ESR_{COUT} \leq \frac{0.01 \cdot V_O}{I_{D(PEAK)}}$$

where:

$$I_{D(PEAK)} = \left(1 + \frac{\chi}{2}\right) \cdot I_{O(MAX)} \cdot \left(\frac{V_O + V_D}{V_{IN(MIN)}} + 1\right)$$

For the bulk C component, which also contributes 1% to the total ripple:

$$C_{OUT} \geq \frac{I_{O(MAX)}}{0.01 \cdot V_O \cdot f}$$

For many designs it is possible to choose a single capacitor type that satisfies both the ESR and bulk C requirements for the design. In certain demanding applications, however, the ripple voltage can be improved significantly by connecting two or more types of capacitors in parallel. For example, using a low ESR ceramic capacitor can minimize the ESR step, while an electrolytic or tantalum capacitor can be used to supply the required bulk C.

Once the output capacitor ESR and bulk capacitance have been determined, the overall ripple voltage waveform should be verified on a dedicated PC board (see Board Layout section for more information on component placement). Lab breadboards generally suffer from excessive series inductance (due to inter-component wiring), and these parasitics can make the switching waveforms look significantly worse than they would be on a properly designed PC board.

## APPLICATIONS INFORMATION

The output capacitor in a SEPIC regulator experiences high RMS ripple currents, as shown in Figure 16. The RMS output capacitor ripple current is:

$$I_{\text{RMS(COUT)}} = I_{\text{O(MAX)}} \cdot \sqrt{\frac{V_{\text{O}}}{V_{\text{IN(MIN)}}}}$$

Note that the ripple current ratings from capacitor manufacturers are often based on only 2000 hours of life. This makes it advisable to further derate the capacitor or to choose a capacitor rated at a higher temperature than required. Several capacitors may also be placed in parallel to meet size or height requirements in the design.

Manufacturers such as Nichicon, United Chemicon and Sanyo should be considered for high performance through-hole capacitors. The OS-CON semiconductor dielectric capacitor available from Sanyo has the lowest product of ESR and size of any aluminum electrolytic, at a somewhat higher price.

In surface mount applications, multiple capacitors may have to be placed in parallel in order to meet the ESR or RMS current handling requirements of the application. Aluminum electrolytic and dry tantalum capacitors are both available in surface mount packages. In the case of tantalum, it is critical that the capacitors have been surge tested for use in switching power supplies. An excellent choice is AVX TPS series of surface mount tantalum. Also, ceramic capacitors are now available with extremely low ESR, ESL and high ripple current ratings.

### SEPIC Converter: Input Capacitor Selection

The input capacitor of a SEPIC converter is less critical than the output capacitor due to the fact that an inductor is in series with the input and the input current waveform is triangular in shape. The input voltage source impedance determines the size of the input capacitor which is typically in the range of 10 $\mu$ F to 100 $\mu$ F. A low ESR capacitor is recommended, although it is not as critical as for the output capacitor.

The RMS input capacitor ripple current for a SEPIC converter is:

$$I_{\text{RMS(CIN)}} = \frac{1}{\sqrt{12}} \cdot \Delta I_{\text{L}}$$

Please note that the input capacitor can see a very high surge current when a battery is suddenly connected to the input of the converter and solid tantalum capacitors can fail catastrophically under these conditions. **Be sure to specify surge-tested capacitors!**

### SEPIC Converter: Selecting the DC Coupling Capacitor

The coupling capacitor C1 in Figure 15 sees nearly a rectangular current waveform as shown in Figure 16. During the switch off-time the current through C1 is  $I_{\text{O}}(V_{\text{O}}/V_{\text{IN}})$  while approximately  $-I_{\text{O}}$  flows during the on-time. This current waveform creates a triangular ripple voltage on C1:

$$\Delta V_{\text{C1(P-P)}} = \frac{I_{\text{O(MAX)}}}{\text{C1} \cdot f} \cdot \frac{V_{\text{O}}}{V_{\text{IN}} + V_{\text{O}} + V_{\text{D}}}$$

The maximum voltage on C1 is then:

$$V_{\text{C1(MAX)}} = V_{\text{IN}} + \frac{\Delta V_{\text{C1(P-P)}}}{2}$$

which is typically close to  $V_{\text{IN(MAX)}}$ . The ripple current through C1 is:

$$I_{\text{RMS(C1)}} = I_{\text{O(MAX)}} \cdot \sqrt{\frac{V_{\text{O}} + V_{\text{D}}}{V_{\text{IN(MIN)}}}}$$

The value chosen for the DC coupling capacitor normally starts with the minimum value that will satisfy 1) the RMS current requirement and 2) the peak voltage requirement (typically close to  $V_{\text{IN}}$ ). Low ESR ceramic and tantalum capacitors work well here.

### SEPIC Converter Design Example

The input voltage is 5V to 15V and the output is 12V at a maximum load current of 1.5A (2A peak).

## APPLICATIONS INFORMATION

1. The duty cycle range is:

$$D = \left( \frac{V_O + V_D}{V_{IN} + V_O + V_D} \right) = 45.5\% \text{ to } 71.4\%$$

2. The operating mode chosen is pulse skipping, so the MODE/SYNC pin is shorted to INTV<sub>CC</sub>.
3. The operating frequency is chosen to be 300kHz to reduce the size of the inductors; the resistor from the FREQ pin to ground is 80k.
4. An inductor ripple current of 40% is chosen, so the peak input current (which is also the minimum saturation current) is:

$$\begin{aligned} I_{L1(\text{PEAK})} &= \left( 1 + \frac{\chi}{2} \right) \cdot I_{O(\text{MAX})} \cdot \frac{V_O + V_D}{V_{IN(\text{MIN})}} \\ &= \left( 1 + \frac{0.4}{2} \right) \cdot 1.5 \cdot \frac{12 + 0.5}{5} = 4.5\text{A} \end{aligned}$$

The inductor ripple current is:

$$\begin{aligned} \Delta I_L &= \chi \cdot I_{O(\text{MAX})} \cdot \frac{D_{\text{MAX}}}{1 - D_{\text{MAX}}} \\ &= 0.4 \cdot 1.5 \cdot \frac{0.714}{1 - 0.714} = 1.5\text{A} \end{aligned}$$

And so the inductor value is:

$$L = \frac{V_{IN(\text{MIN})}}{2 \cdot \Delta I_L \cdot f} \cdot D_{\text{MAX}} = \frac{5}{2 \cdot 1.5 \cdot 300\text{k}} \cdot 0.714 = 4\mu\text{H}$$

The component chosen is a BH Electronics BH510-1007, which has a saturation current of 8A.

5. With an minimum input voltage of 5V, only logic-level power MOSFETs should be considered. Because the maximum duty cycle is 71.4%, the maximum SENSE pin threshold voltage is reduced from its low duty cycle typical value of 150mV to approximately 120mV.

Assuming a MOSFET junction temperature of 125°C, the room temperature MOSFET R<sub>DS(ON)</sub> should be less than:

$$\begin{aligned} R_{DS(\text{ON})} &\leq \frac{V_{\text{SENSE}(\text{MAX})}}{I_{O(\text{MAX})}} \cdot \frac{1}{\left( 1 + \frac{\chi}{2} \right) \cdot P_T} \cdot \frac{1}{\left( \frac{V_O + V_D}{V_{IN(\text{MIN})}} \right) + 1} \\ &= \frac{0.12}{1.5} \cdot \frac{1}{1.2 \cdot 1.5} \cdot \frac{1}{\left( \frac{12.5}{5} \right) + 1} = 12.7\text{m}\Omega \end{aligned}$$

For a SEPIC converter, the switch BV<sub>DSS</sub> rating must be greater than V<sub>IN(MAX)</sub> + V<sub>O</sub>, or 27V. This comes close to an IRF7811W, which is rated to 30V, and has a maximum room temperature R<sub>DS(ON)</sub> of 12mΩ at V<sub>GS</sub> = 4.5V.

6. The diode for this design must handle a maximum DC output current of 2A and be rated for a minimum reverse voltage of V<sub>IN</sub> + V<sub>OUT</sub>, or 27V. A 3A, 40V diode from International Rectifier (30BQ040) is chosen for its small size, relatively low forward drop and acceptable reverse leakage at high temp.
7. The output capacitor usually consists of a high valued bulk C connected in parallel with a lower valued, low ESR ceramic. Based on a maximum output ripple voltage of 1%, or 120mV, the bulk C needs to be greater than:

$$\begin{aligned} C_{\text{OUT}} &\geq \frac{I_{\text{OUT}(\text{MAX})}}{0.01 \cdot V_{\text{OUT}} \cdot f} = \\ &= \frac{1.5\text{A}}{0.01 \cdot 12\text{V} \cdot 300\text{kHz}} = 41\mu\text{F} \end{aligned}$$

The RMS ripple current rating for this capacitor needs to exceed:

$$\begin{aligned} I_{\text{RMS}(\text{COUT})} &\geq I_{O(\text{MAX})} \cdot \sqrt{\frac{V_O}{V_{IN(\text{MIN})}}} = \\ &= 1.5\text{A} \cdot \sqrt{\frac{12\text{V}}{5\text{V}}} = 2.3\text{A} \end{aligned}$$

## APPLICATIONS INFORMATION

To satisfy this high RMS current demand, two 47 $\mu$ F Kemet capacitors (T495X476K020AS) are required. As a result, the output ripple voltage is a low 50mV to 60mV. In parallel with these tantalums, two 10 $\mu$ F, low ESR (X5R) Taiyo Yuden ceramic capacitors (TMK-432BJ106MM) are added for HF noise reduction. Check the output ripple with a single oscilloscope probe connected directly across the output capacitor terminals, where the HF switching currents flow.

- The choice of an input capacitor for a SEPIC converter depends on the impedance of the source supply and the amount of input ripple the converter will safely tolerate. For this particular design and lab setup, a single 47 $\mu$ F Kemet tantalum capacitor (T495X476K020AS) is adequate. As with the output node, check the input ripple with a single oscilloscope probe connected across the input capacitor terminals. If any HF switching noise is

observed it is a good idea to decouple the input with a low ESR, X5R ceramic capacitor as close to the  $V_{IN}$  and GND pins as possible.

- The DC coupling capacitor in a SEPIC converter is chosen based on its RMS current requirement and must be rated for a minimum voltage of  $V_{IN}$  plus the AC ripple voltage. Start with the minimum value which satisfies the RMS current requirement and then check the ripple voltage to ensure that it doesn't exceed the DC rating.

$$I_{RMS(CI)} \geq I_{O(MAX)} \cdot \sqrt{\frac{V_O + V_D}{V_{IN(MIN)}}}$$

$$= 1.5A \cdot \sqrt{\frac{12V + 0.5V}{5V}} = 2.4A$$

For this design a single 10 $\mu$ F, low ESR (X5R) Taiyo Yuden ceramic capacitor (TMK432BJ106MM) is adequate.

# PACKAGE DESCRIPTION

Please refer to <http://www.linear.com/product/LTC1871X#packaging> for the most recent package drawings.

**MS Package**  
**10-Lead Plastic MSOP**  
 (Reference LTC DWG # 05-08-1661 Rev F)

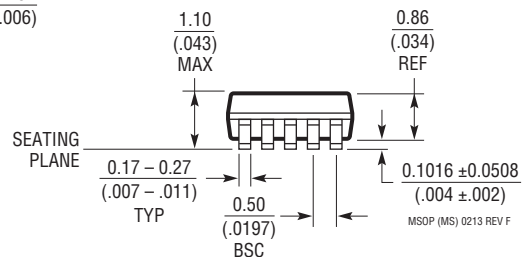
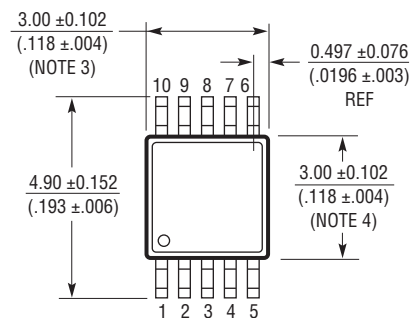
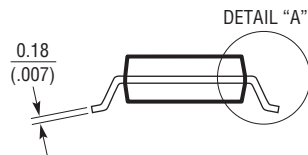
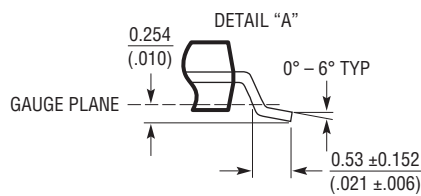
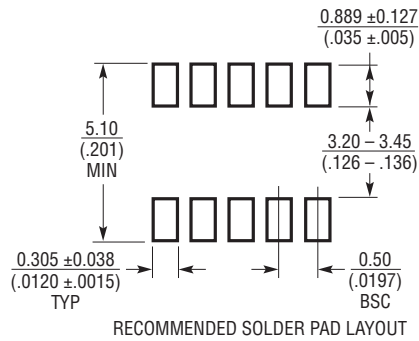

- NOTE:
1. DIMENSIONS IN MILLIMETER/(INCH)
  2. DRAWING NOT TO SCALE
  3. DIMENSION DOES NOT INCLUDE MOLD FLASH, PROTRUSIONS OR GATE BURRS.  
MOLD FLASH, PROTRUSIONS OR GATE BURRS SHALL NOT EXCEED 0.152mm (.006") PER SIDE
  4. DIMENSION DOES NOT INCLUDE INTERLEAD FLASH OR PROTRUSIONS.  
INTERLEAD FLASH OR PROTRUSIONS SHALL NOT EXCEED 0.152mm (.006") PER SIDE
  5. LEAD COPLANARITY (BOTTOM OF LEADS AFTER FORMING) SHALL BE 0.102mm (.004") MAX

## TYPICAL APPLICATION

High Efficiency 5V Input, 12V Output Boost Converter (Bootstrapped)

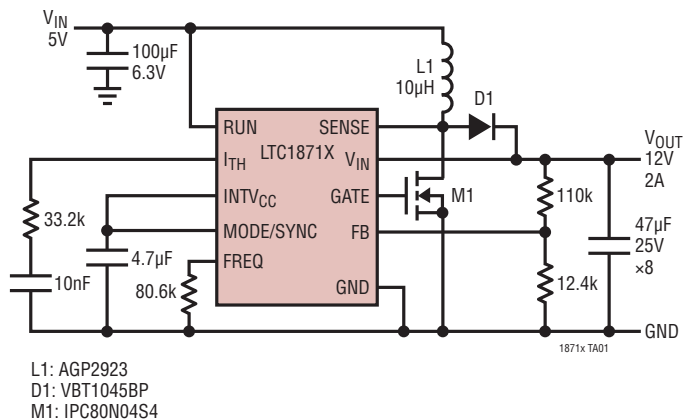

## RELATED PARTS

PART NUMBER	DESCRIPTION	COMMENTS
<a href="#">LT<sup>®</sup>1619</a>	Current Mode PWM Controller	300kHz Fixed Frequency, Boost, SEPIC, Flyback Topology
<a href="#">LTC1624</a>	Current Mode DC/DC Controller	SO-8; 300kHz Operating Frequency; Buck, Boost, SEPIC Design; $V_{IN}$ Up to 36V
<a href="#">LTC1700</a>	No $R_{SENSE}$ Synchronous Step-Up Controller	Up to 95% Efficiency, Operation as Low as 0.9V Input
<a href="#">LTC1871-7</a>	Wide Input Range Controller	No $R_{SENSE}$ , 7V Gate Drive, Current Mode Control
<a href="#">LTC1872</a>	SOT-23 Boost Controller	Delivers Up to 5A, 550kHz Fixed Frequency, Current Mode
<a href="#">LT1930</a>	1.2MHz, SOT-23 Boost Converter	Up to 34V Output, $2.6V \leq V_{IN} \leq 16V$ , Miniature Design
<a href="#">LT1931</a>	Inverting 1.2MHz, SOT-23 Converter	Positive-to-Negative DC/DC Conversion, Miniature Design
<a href="#">LTC3401/LTC3402</a>	1A/2A 3MHz Synchronous Boost Converters	Up to 97% Efficiency, Very Small Solution, $0.5V \leq V_{IN} \leq 5V$
<a href="#">LTC3704</a>	Positive-to-Negative DC/DC Controller	No $R_{SENSE}$ , Current Mode Control, 50kHz to 1MHz
<a href="#">LT3782</a>	2-Phase Step-Up DC/DC Controller	$6V \leq V_{IN} \leq 40V$ ; 4A Gate Drive, 150kHz to 500kHz