



# RF Power LDMOS Transistor

## High Ruggedness N-Channel Enhancement-Mode Lateral MOSFET

This high ruggedness device is designed for use in high VSWR industrial, medical, broadcast, aerospace and mobile radio applications. Its unmatched input and output design supports frequency use from 1.8 to 400 MHz.

### Typical Performance

Frequency (MHz)	Signal Type	V <sub>DD</sub> (V)	P <sub>out</sub> (W)	G <sub>ps</sub> (dB)	η <sub>D</sub> (%)
27 (1)	CW	65	1800 CW	27.8	75.6
64	Pulse (100 μsec, 10% Duty Cycle)	65	1800 Peak	27.1	69.5
81.36	CW	63	1700 CW	24.5	76.3
87.5–108 (2,3)	CW	60	1600 CW	23.6	82.5
123/128	Pulse (100 μsec, 10% Duty Cycle)	65	1800 Peak	25.9	69.0
144	CW	65	1800 CW	23.5	78.0
230 (4)	Pulse (100 μsec, 20% Duty Cycle)	65	1800 Peak	25.1	75.1
325	Pulse (12 μsec, 10% Duty Cycle)	63	1700 Peak	22.8	64.9

### Load Mismatch/Ruggedness

Frequency (MHz)	Signal Type	VSWR	P <sub>in</sub> (W)	Test Voltage	Result
230 (4)	Pulse (100 μsec, 20% Duty Cycle)	> 65:1 at all Phase Angles	14 W Peak (3 dB Overdrive)	65	No Device Degradation

1. Data from 27 MHz narrowband reference circuit (page 5).
2. Data from 87.5–108 MHz broadband reference circuit (page 10).
3. The values shown are the center band performance numbers across the indicated frequency range.
4. Data from 230 MHz narrowband production test fixture (page 16).

### Features

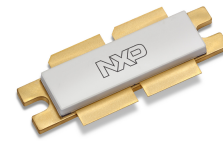
- Unmatched input and output allowing wide frequency range utilization
- Device can be used single-ended or in a push-pull configuration
- Qualified up to a maximum of 65 V<sub>DD</sub> operation
- Characterized from 30 to 65 V for extended power range
- High breakdown voltage for enhanced reliability
- Suitable for linear application with appropriate biasing
- Integrated ESD protection with greater negative gate-source voltage range for improved Class C operation
- Lower thermal resistance option in over-molded plastic package: MRFX1K80N
- Included in NXP product longevity program with assured supply for a minimum of 15 years after launch

### Typical Applications

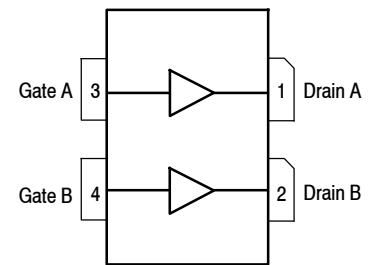
- Industrial, scientific, medical (ISM)
  - Laser generation
  - Plasma generation
  - Particle accelerators
  - MRI, RF ablation and skin treatment
  - Industrial heating, welding and drying systems
- Radio and VHF TV broadcast
- Aerospace
  - VHF omnidirectional range (VOR)
  - HF communications
  - Weather radar

## MRFX1K80H

**1.8–400 MHz, 1800 W CW, 65 V  
 WIDEBAND  
 RF POWER LDMOS TRANSISTOR**



NI-1230H-4S



(Top View)

Note: The backside of the package is the source terminal for the transistor.

**Figure 1. Pin Connections**

**Table 1. Maximum Ratings**

Rating	Symbol	Value	Unit
Drain-Source Voltage	$V_{DSS}$	-0.5, +179	Vdc
Gate-Source Voltage	$V_{GS}$	-6.0, +10	Vdc
Storage Temperature Range	$T_{stg}$	-65 to +150	°C
Case Operating Temperature Range	$T_C$	-40 to +150	°C
Operating Junction Temperature Range (1,2)	$T_J$	-40 to +225	°C
Total Device Dissipation @ $T_C = 25^\circ\text{C}$ Derate above 25°C	$P_D$	2247 11.2	W W/°C

**Table 2. Thermal Characteristics**

Characteristic	Symbol	Value (2,3)	Unit
Thermal Resistance, Junction to Case CW: Case Temperature 99°C, 1800 W CW, 65 Vdc, $I_{DQ(A+B)} = 150$ mA, 98 MHz	$R_{\theta JC}$	0.09	°C/W
Thermal Impedance, Junction to Case Pulse: Case Temperature 65°C, 1800 W Peak, 100 $\mu\text{sec}$ Pulse Width, 20% Duty Cycle, 65 Vdc, $I_{DQ(A+B)} = 100$ mA, 230 MHz	$Z_{\theta JC}$	0.017	°C/W

**Table 3. ESD Protection Characteristics**

Test Methodology	Class
Human Body Model (per JESD22-A114)	2, passes 2500 V
Charge Device Model (per JESD22-C101)	C3, passes 2000 V

**Table 4. Electrical Characteristics** ( $T_A = 25^\circ\text{C}$  unless otherwise noted)

Characteristic	Symbol	Min	Typ	Max	Unit
<b>Off Characteristics (4)</b>					
Gate-Source Leakage Current ( $V_{GS} = 5$ Vdc, $V_{DS} = 0$ Vdc)	$I_{GSS}$	—	—	1	$\mu\text{Adc}$
Drain-Source Breakdown Voltage ( $V_{GS} = 0$ Vdc, $I_D = 100$ mAdc)	$V_{(BR)DSS}$	179	193	—	Vdc
Zero Gate Voltage Drain Leakage Current ( $V_{DS} = 65$ Vdc, $V_{GS} = 0$ Vdc)	$I_{DSS}$	—	—	10	$\mu\text{Adc}$
Zero Gate Voltage Drain Leakage Current ( $V_{DS} = 179$ Vdc, $V_{GS} = 0$ Vdc)	$I_{DSS}$	—	—	100	mAdc

**On Characteristics**

Gate Threshold Voltage (4) ( $V_{DS} = 10$ Vdc, $I_D = 740$ $\mu\text{Adc}$ )	$V_{GS(th)}$	2.1	2.5	2.9	Vdc
Gate Quiescent Voltage ( $V_{DD} = 65$ Vdc, $I_{D(A+B)} = 100$ mAdc, Measured in Functional Test)	$V_{GS(Q)}$	2.4	2.8	3.2	Vdc
Drain-Source On-Voltage (4) ( $V_{GS} = 10$ Vdc, $I_D = 2.76$ Adc)	$V_{DS(on)}$	—	0.21	—	Vdc
Forward Transconductance (4) ( $V_{DS} = 10$ Vdc, $I_D = 43$ Adc)	$g_{fs}$	—	44.7	—	S

1. Continuous use at maximum temperature will affect MTTF.
2. MTTF calculator available at <http://www.nxp.com/RF/calculators>.
3. Refer to AN1955, *Thermal Measurement Methodology of RF Power Amplifiers*. Go to <http://www.nxp.com/RF> and search for AN1955.
4. Each side of device measured separately.

(continued)

**Table 4. Electrical Characteristics** ( $T_A = 25^\circ\text{C}$  unless otherwise noted) (continued)

Characteristic	Symbol	Min	Typ	Max	Unit
<b>Dynamic Characteristics</b> <sup>(1)</sup>					
Reverse Transfer Capacitance ( $V_{DS} = 65\text{ Vdc} \pm 30\text{ mV(rms)ac}$ @ 1 MHz, $V_{GS} = 0\text{ Vdc}$ )	$C_{rss}$	—	2.9	—	pF
Output Capacitance ( $V_{DS} = 65\text{ Vdc} \pm 30\text{ mV(rms)ac}$ @ 1 MHz, $V_{GS} = 0\text{ Vdc}$ )	$C_{oss}$	—	203	—	pF
Input Capacitance ( $V_{DS} = 65\text{ Vdc}$ , $V_{GS} = 0\text{ Vdc} \pm 30\text{ mV(rms)ac}$ @ 1 MHz)	$C_{iss}$	—	760	—	pF

**Functional Tests** (In NXP Production Test Fixture, 50 ohm system)  $V_{DD} = 65\text{ Vdc}$ ,  $I_{DQ(A+B)} = 100\text{ mA}$ ,  $P_{out} = 1800\text{ W Peak}$  (360 W Avg.),  $f = 230\text{ MHz}$ , 100  $\mu\text{sec}$  Pulse Width, 20% Duty Cycle

Power Gain	$G_{ps}$	24.0	25.1	26.5	dB
Drain Efficiency	$\eta_D$	70.0	75.1	—	%
Input Return Loss	IRL	—	-14.4	-9	dB

**Table 5. Load Mismatch/Ruggedness** (In NXP Production Test Fixture, 50 ohm system)  $I_{DQ(A+B)} = 100\text{ mA}$ 

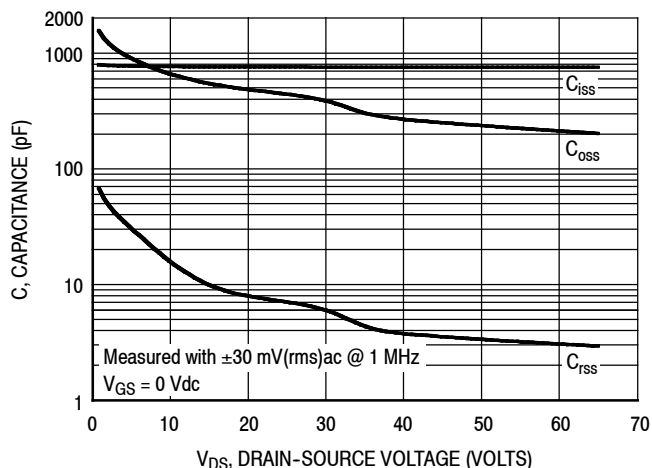
Frequency (MHz)	Signal Type	VSWR	$P_{in}$ (W)	Test Voltage, $V_{DD}$	Result
230	Pulse (100 $\mu\text{sec}$ , 20% Duty Cycle)	> 65:1 at all Phase Angles	14 W Peak (3 dB Overdrive)	65	No Device Degradation

**Table 6. Ordering Information**

Device	Tape and Reel Information	Package
MRFX1K80HR5	R5 Suffix = 50 Units, 56 mm Tape Width, 13-inch Reel	NI-1230H-4S

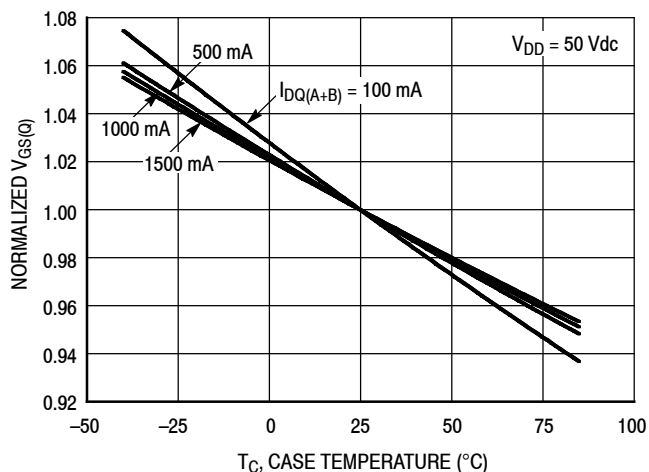
1. Each side of device measured separately.

### TYPICAL CHARACTERISTICS



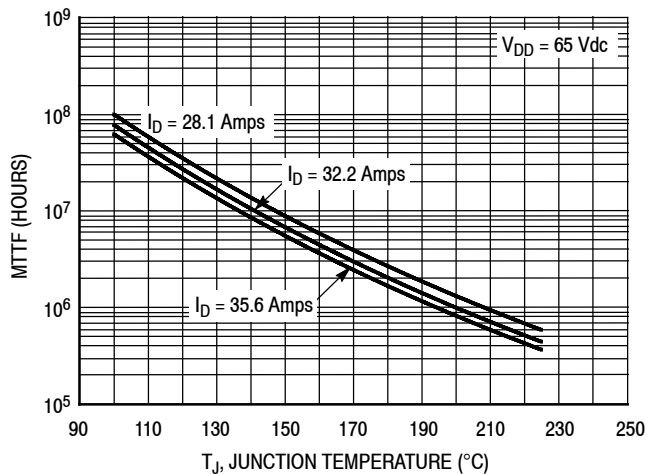
**Note:** Each side of device measured separately.

**Figure 2. Capacitance versus Drain-Source Voltage**



$I_{DQ}$ (mA)	Slope (mV/°C)
100	-3.21
500	-2.79
1000	-2.69
1500	-2.61

**Figure 3. Normalized  $V_{GS}$  versus Quiescent Current and Case Temperature**



**Note:** MTTF value represents the total cumulative operating time under indicated test conditions.

MTTF calculator available at <http://www.nxp.com/RF/calculators>.

**Figure 4. MTTF versus Junction Temperature – CW**

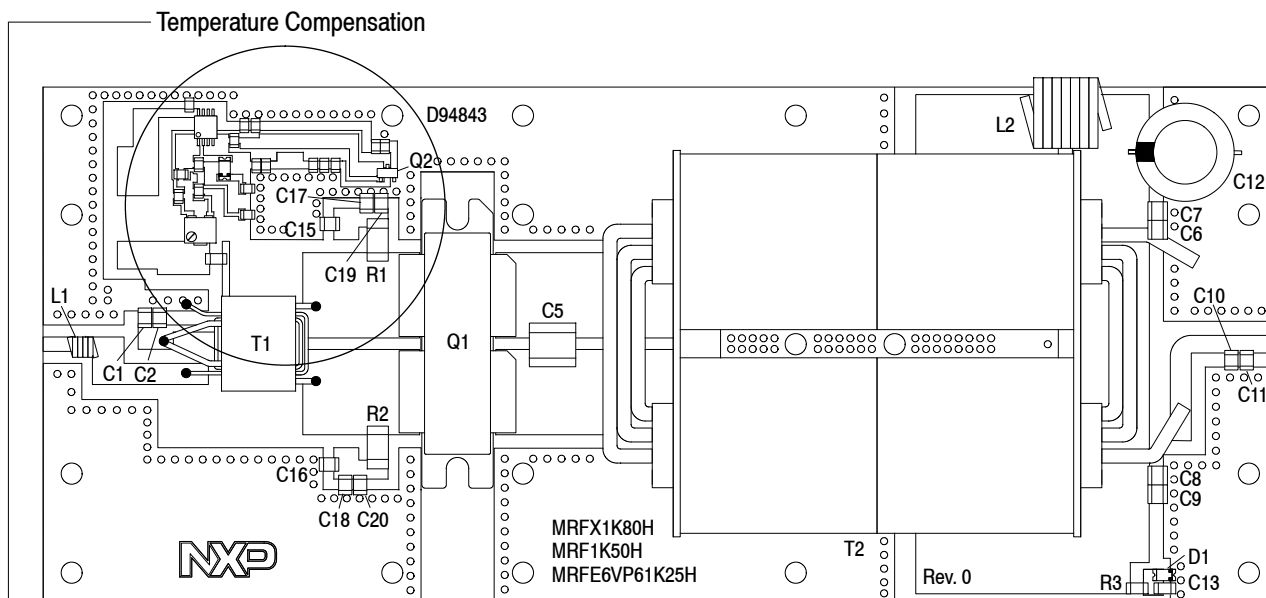
## 27 MHz NARROWBAND REFERENCE CIRCUIT – 2.9" × 6.9" (73 mm × 175 mm)

**Table 7. 27 MHz Narrowband Performance** (In NXP Reference Circuit, 50 ohm system)

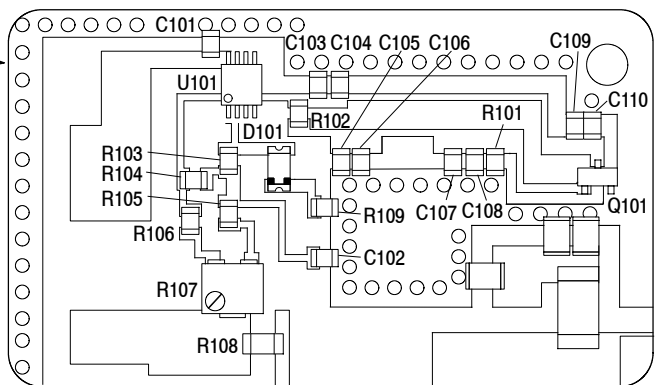
$I_{DQ(A+B)} = 200 \text{ mA}$ ,  $P_{in} = 3 \text{ W}$ , CW

Frequency (MHz)	V <sub>DD</sub> (V)	P <sub>out</sub> (W)	G <sub>ps</sub> (dB)	$\eta_D$ (%)
27	50	1200	26.0	82.3
	57.5	1520	27.0	80.1
	65	1800	27.8	75.6

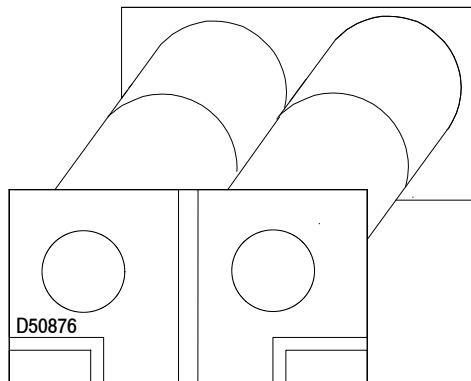
27 MHz NARROWBAND REFERENCE CIRCUIT – 2.9" x 6.9" (73 mm x 175 mm)



Note: Component numbers C3, C4 and C14 are not used.



Temperature Compensation Detail



T2 Transformer Detail

Figure 5. MRFX1K80H Narrowband Reference Circuit Component Layout – 27 MHz

## 27 MHz NARROWBAND REFERENCE CIRCUIT – 2.9" × 6.9" (73 mm × 175 mm)

**Table 8. MRFX1K80H Narrowband Reference Circuit Component Designations and Values – 27 MHz**

Part	Description	Part Number	Manufacturer
C1, C17, C18	1000 pF Chip Capacitor	ATC100B102JT50XT	ATC
C2, C15, C16	39 K pF Chip Capacitor	ATC200B393KT50XT	ATC
C5	470 pF Chip Capacitor	ATC100C471JT2500XT	ATC
C6, C8	2.2 μF Chip Capacitor	HMK432B7225KM-T	Taiyo Yuden
C7, C9, C19, C20	470 pF Chip Capacitor	ATC100B471JT200XT	ATC
C10, C11	22 pF Chip Capacitor	ATC100B220JT500XT	ATC
C12	470 μF, 100 V Electrolytic Capacitor	MCGPR100V477M16X32-RH	Multicomp
C13	1000 pF Chip Capacitor	C2012X7R2E102M	TDK
D1	Green LED, 1206	LG N971-KN-1	OSRAM
L1	82 nH Inductor	1812SMS-82NJLC	Coilcraft
L2	7 Turns, #16 AWG, ID = 10 mm Inductor, Hand Wound	8074	Belden
Q1	RF Power LDMOS Transistor	MRFX1K80H	NXP
R1, R2	33 Ω, 3 W Chip Resistor	1-2176070-3	TE Connectivity
R3	9.1 kΩ, 1/4 W Chip Resistor	CRCW12069K10FKEA	Vishay
PCB	Arlon TC350 0.030" ε <sub>r</sub> = 3.5	D94843	MTL

### Transformer

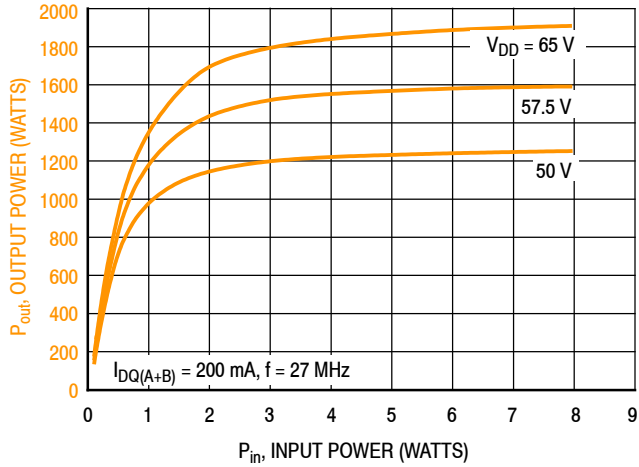
T1 Core	Multi-Aperture Core, 43 Material	2843000302	Fair-Rite
T1 Primary	2 Turns, #20 AWG Magnetic Wire	8076	Belden
T1 Secondary	1 Turn, #24 AWG Teflon Wire	5854/7 BL005	Alpha Wire
T2 Core	61 Round Cable Core, x4	2661102002	Fair-Rite
T2 Primary	Copper Pipe, Type L, ID = 3/8", OD = 1/2", cut to 2.4"	LH03010	Mueller
T2 Secondary	3 Turns, #16 AWG PTFE Covered Wire, Twisted	TEF16	RF Parts Company
T2 PCB	Arlon TC350 0.030" ε <sub>r</sub> = 3.5, x2	D50876	MTL

### Temperature Compensation

C101, C102, C104, C106, C108, C110	1 μF Chip Capacitor	GRM21BR71H105KA12L	Murata
C103, C105, C107, C109	1 nF Chip Capacitor	C2012X7R2E102M	TDK
D101	Red LED, 1206	LH N974-KN-1	OSRAM
Q101	NPN Bipolar Transistor	BC847ALT1G	ON Semiconductor
R101	2.2 kΩ, 1/8 W Chip Resistor	CRCW08052K20JNEA	Vishay
R102, R109	1.2 kΩ, 1/8 W Chip Resistor	CRCW08051K20FKEA	Vishay
R103	10 Ω, 1/8 W Chip Resistor	RK73H2ATTD10R0F	KOA Speer
R104	1 kΩ, 1/8 W Chip Resistor	RR1220P-102-D	Susumu
R105	3.9 kΩ, 1/8 W Chip Resistor	CRCW08053K90JNEA	Vishay
R106	200 Ω, 1/8 W Chip Resistor	CRCW0805200RJNEA	Vishay
R107	5 kΩ Multi-turn Cermet Trimming Potentiometer, 11 Turns	3224W-1-502E	Bourns
R108	10 Ω, 1/4 W Chip Resistor	CRCW120610R0JNEA	Vishay
U101	Voltage Regulator 5 V, Micro8	LP2951ACDMR2G	ON Semiconductor

Note: Refer to MRFX1K80H's [printed circuit boards and schematics](#) to download the 27 MHz heatsink drawing.

## TYPICAL CHARACTERISTICS



f (MHz)	V <sub>DD</sub> (V)	P <sub>1dB</sub> (W)	P <sub>sat</sub> (W)
27	50	825	1250
	57.5	1010	1600
	65	1150	1900

Figure 6. CW Output Power versus Input Power and Drain-Source Voltage

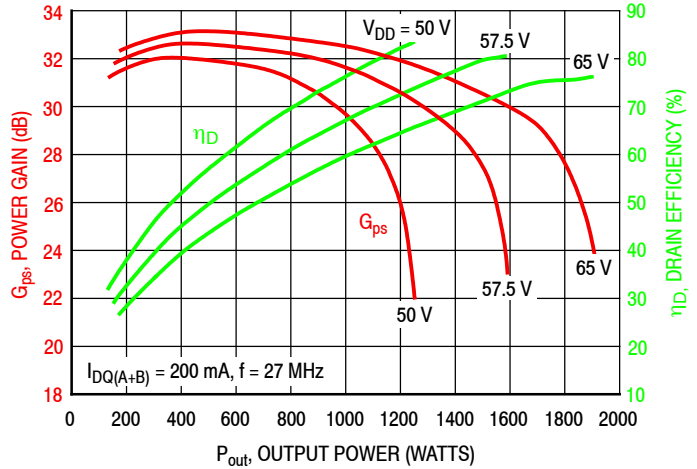


Figure 7. Power Gain and Drain Efficiency versus CW Output Power and Drain-Source Voltage



## 27 MHz NARROWBAND REFERENCE CIRCUIT

f MHz	Z <sub>source</sub> Ω	Z <sub>load</sub> Ω
27	8.70 + j6.28	6.21 + j2.68

Z<sub>source</sub> = Test circuit impedance as measured from gate to gate, balanced configuration.

Z<sub>load</sub> = Test circuit impedance as measured from drain to drain, balanced configuration.

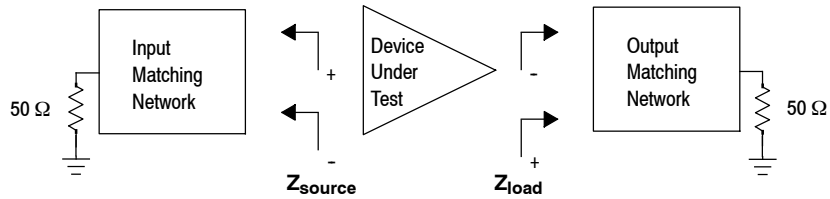


Figure 8. Narrowband Series Equivalent Source and Load Impedance – 27 MHz

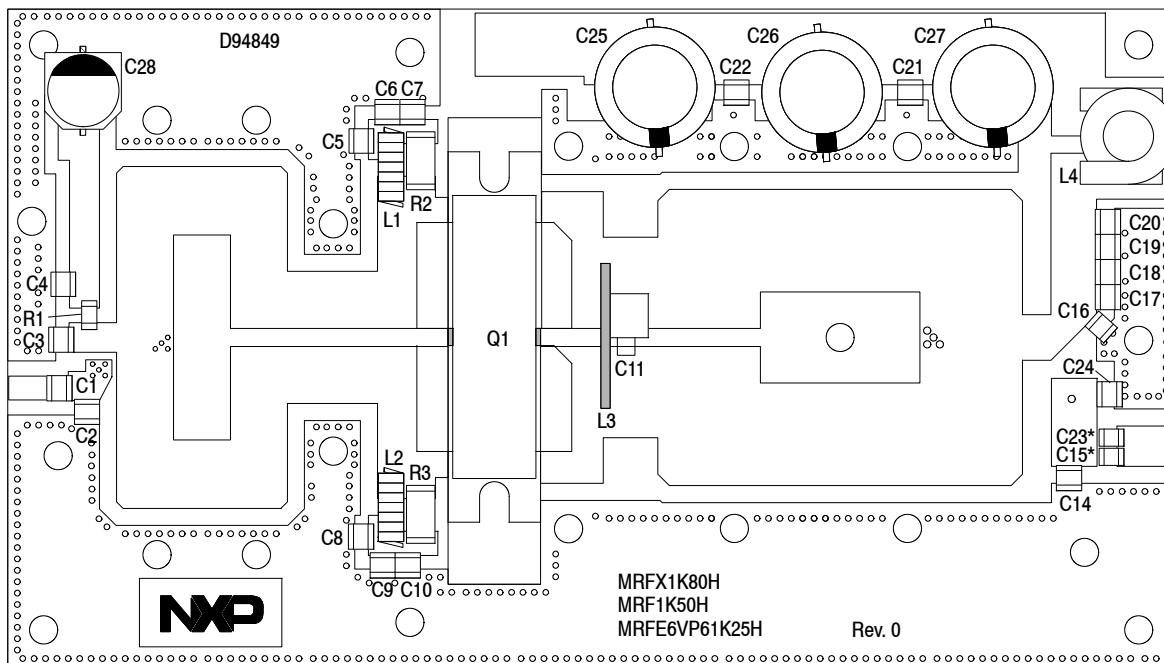
## 87.5–108 MHz BROADBAND REFERENCE CIRCUIT – 2.9" × 5.1" (73 mm × 130 mm)

**Table 9. 87.5–108 MHz Broadband Performance** (In NXP Reference Circuit, 50 ohm system)

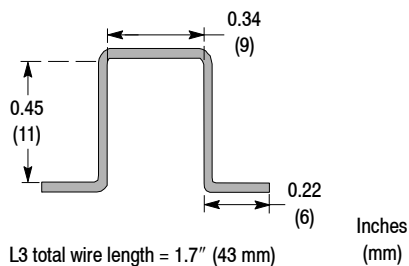
$I_{DQ(A+B)} = 200 \text{ mA}$ ,  $P_{in} = 7 \text{ W}$ , CW

Frequency (MHz)	$V_{DD}$ (V)	$P_{out}$ (W)	$G_{ps}$ (dB)	$\eta_D$ (%)
87.5	60	1521	23.4	84.9
98	60	1600	23.6	82.5
108	60	1556	23.5	80.0

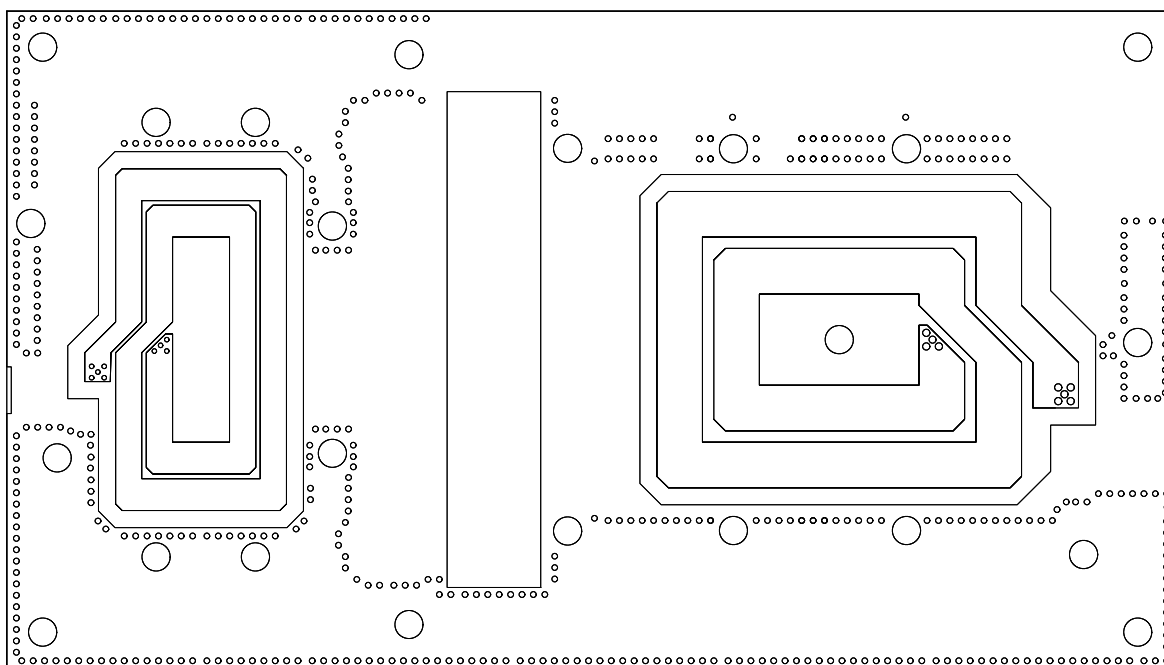
**87.5–108 MHz BROADBAND REFERENCE CIRCUIT – 2.9" x 5.1" (73 mm x 130 mm)**



\*C15 and C23 are mounted vertically.



**Figure 9. MRFX1K80H 87.5–108 MHz Broadband Reference Circuit Component Layout**



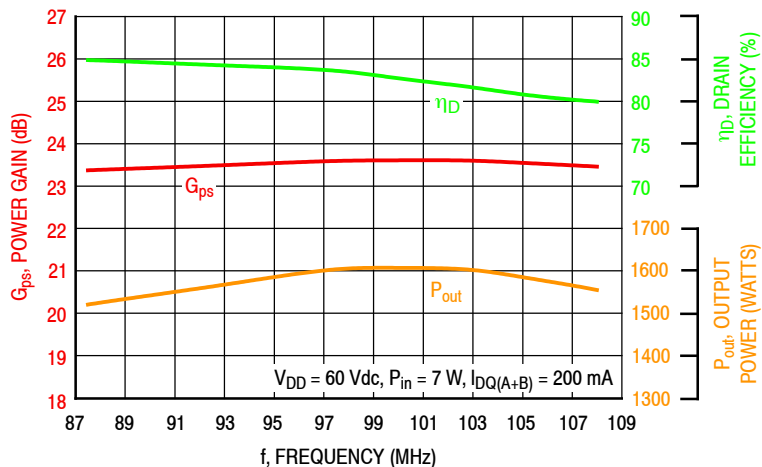
**Figure 10. MRFX1K80H 87.5–108 MHz Broadband Reference Circuit Component Layout – Bottom**

**Table 10. MRFX1K80H 87.5–108 MHz Broadband Reference Circuit Component Designations and Values**

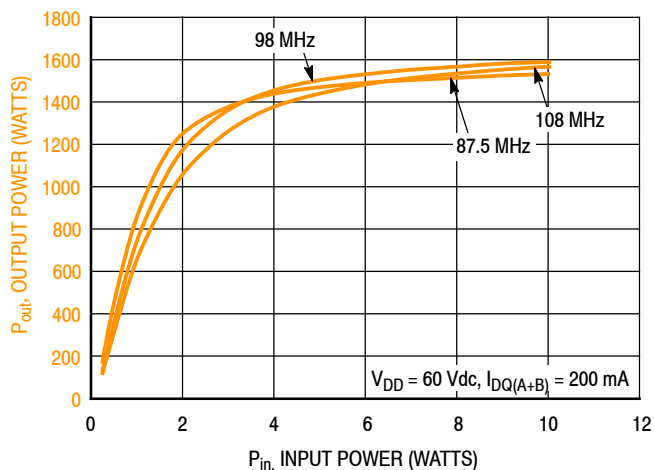
Part	Description	Part Number	Manufacturer
C1, C3, C6, C9, C18, C19, C20, C21, C22	1000 pF Chip Capacitor	ATC100B102JT50XT	ATC
C2	33 pF Chip Capacitor	ATC100B330JT500XT	ATC
C4, C5, C8	10 nF Chip Capacitor	ATC200B103KT50XT	ATC
C7, C10, C15, C16, C17, C23	470 pF Chip Capacitor	ATC100B471JT200XT	ATC
C11	100 pF, 300 V Mica Capacitor	MIN02-002EC101J-F	CDE
C14, C24	12 pF Chip Capacitor	ATC100B120GT500XT	ATC
C25, C26, C27	220 $\mu$ F, 100 V Electrolytic Capacitor	EEV-FC2A221M	Panasonic-ECG
C28	22 $\mu$ F, 35 V Electrolytic Capacitor	UUD1V220MCL1GS	Nichicon
L1, L2	17.5 nH Inductor, 6 Turns	B06TJLC	Coilcraft
L3	1.5 mm Non-Tarnish Silver Plated Copper Wire, Total Wire Length = 1.7"/43 mm	SP1500NT-001	Scientific Wire Company
L4	22 nH Inductor	1212VS-22NMEB	Coilcraft
Q1	RF Power LDMOS Transistor	MRFX1K80H	NXP
R1	10 $\Omega$ , 1/4 W Chip Resistor	CRCW120610R0JNEA	Vishay
R2, R3	33 $\Omega$ , 2 W Chip Resistor	1-2176070-3	TE Connectivity
Thermal Pad	TG Series Soft Thermal Conductive Pad	TG6050-150-150-5.0-0	t-Global Technology
PCB	Arlon TC350 0.030", $\epsilon_r = 3.5$	D94849	MTL

Note: Refer to MRFX1K80H's [printed circuit boards and schematics](#) to download the 87.5–108 MHz heatsink drawing.

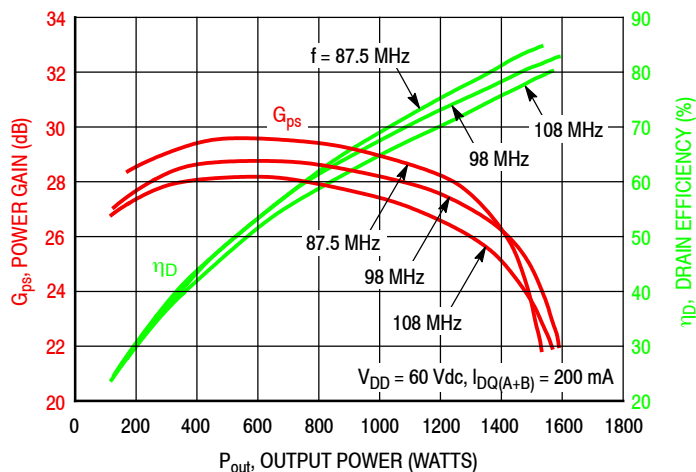
**TYPICAL CHARACTERISTICS – 87.5–108 MHz, 60 V  
BROADBAND REFERENCE CIRCUIT**



**Figure 11. Power Gain, Drain Efficiency and CW Output Power versus Frequency at a Constant Input Power**

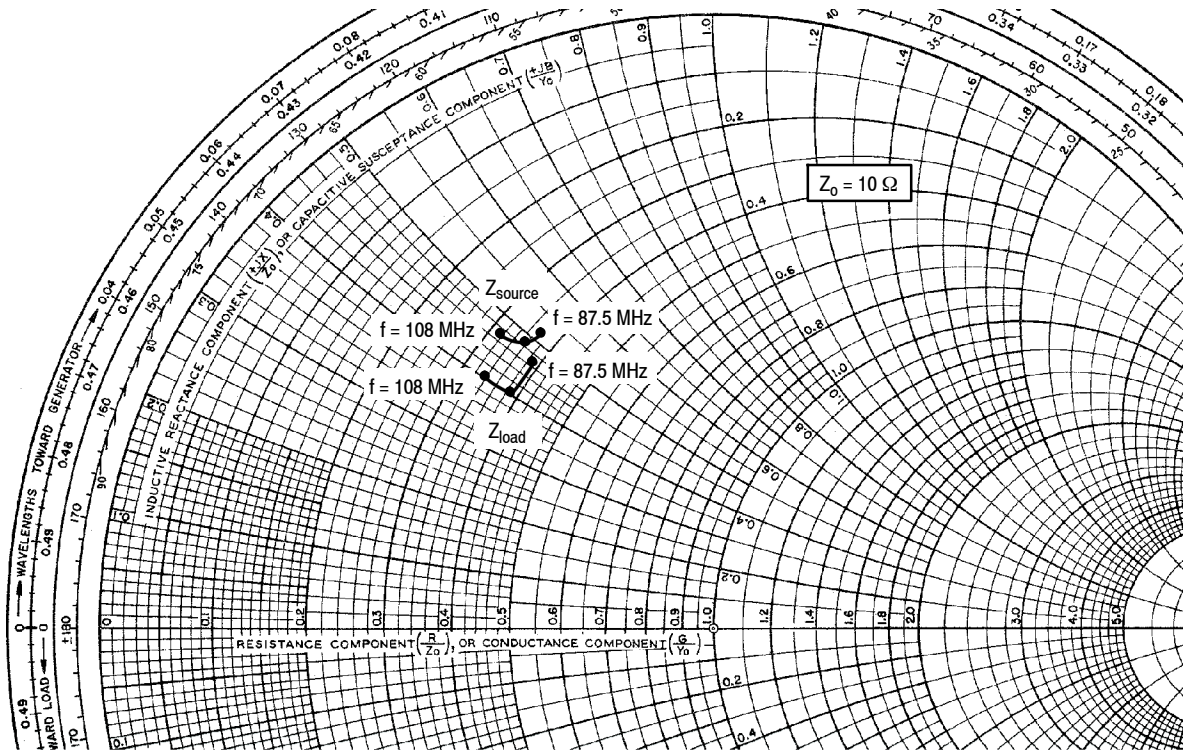


**Figure 12. CW Output Power versus Input Power and Frequency**



**Figure 13. Power Gain and Drain Efficiency versus CW Output Power and Frequency**

## 87.5–108 MHz BROADBAND REFERENCE CIRCUIT



f MHz	Z <sub>source</sub> Ω	Z <sub>load</sub> Ω
87.5	3.69 + j5.19	3.90 + j4.73
98	3.60 + j4.90	3.88 + j3.99
108	3.16 + j4.69	3.35 + j3.95

Z<sub>source</sub> = Test circuit impedance as measured from gate to gate, balanced configuration.

Z<sub>load</sub> = Test circuit impedance as measured from drain to drain, balanced configuration.

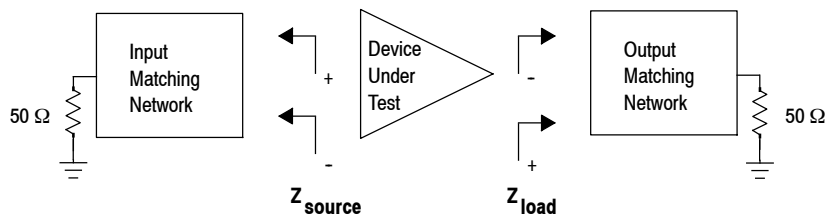
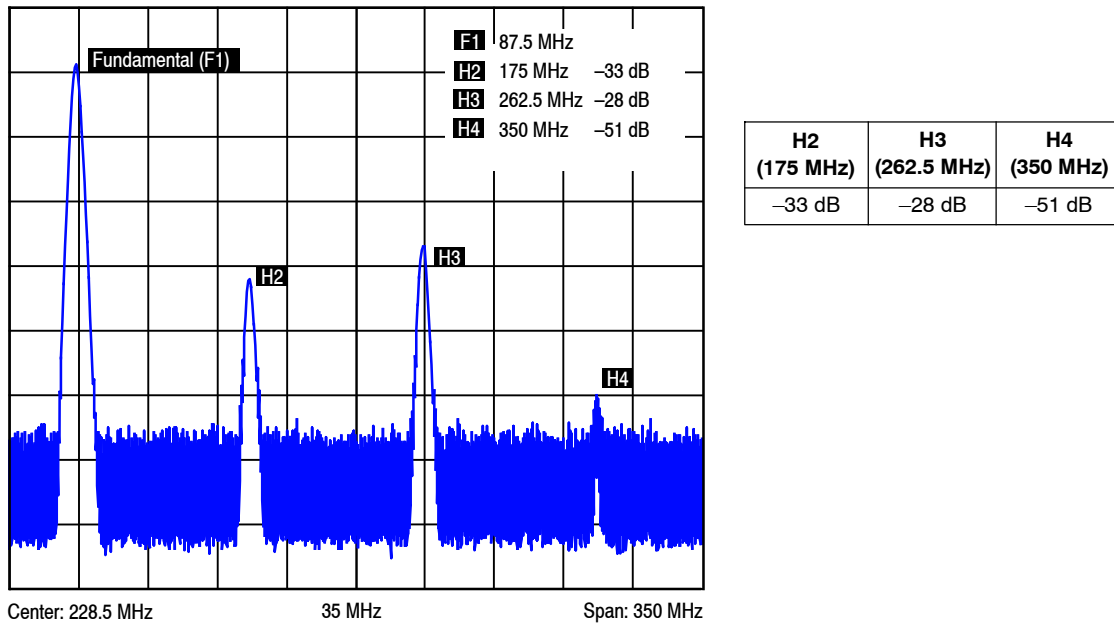


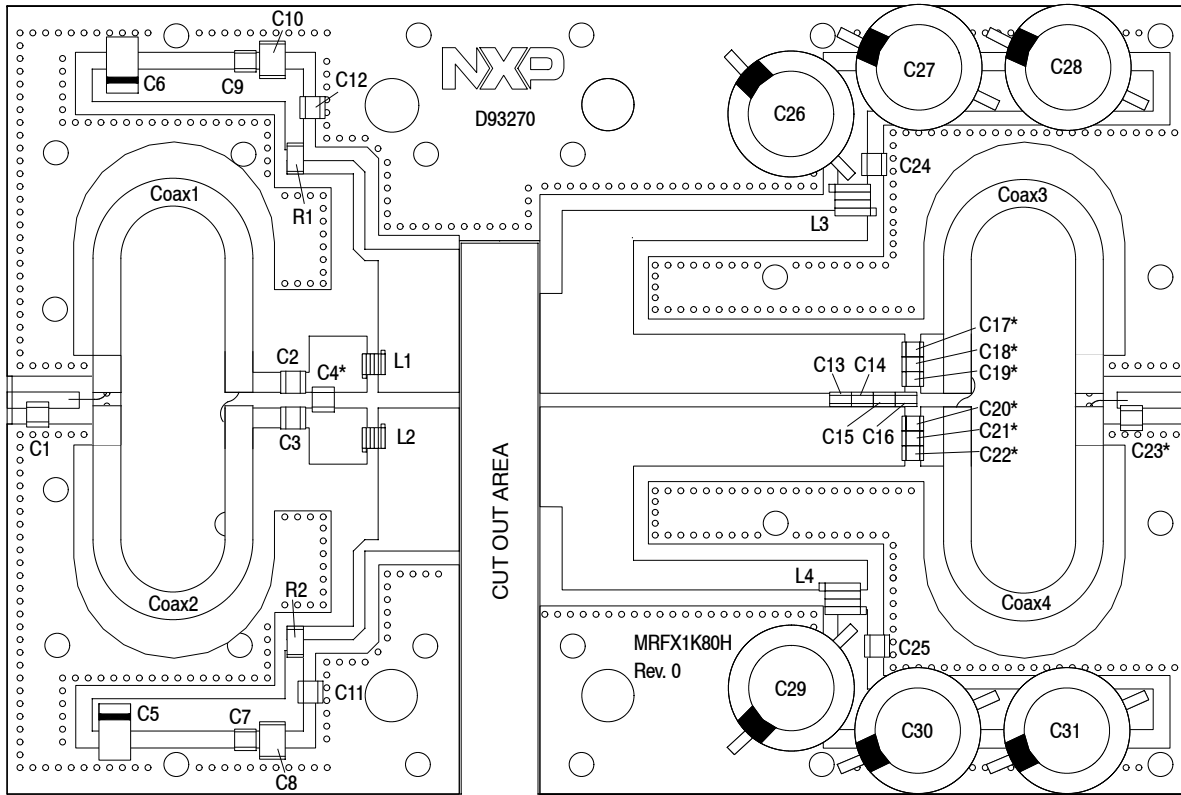
Figure 14. Broadband Series Equivalent Source and Load Impedance – 87.5–108 MHz

**HARMONIC MEASUREMENTS — 87.5–108 MHz  
BROADBAND REFERENCE CIRCUIT**



**Figure 15. 87.5 MHz Harmonics @ 1300 W CW**

230 MHz NARROWBAND PRODUCTION TEST FIXTURE – 6.0" x 4.0" (152 mm x 102 mm)



\*C4, C17, C18, C19, C20, C21, C22 and C23 are mounted vertically.

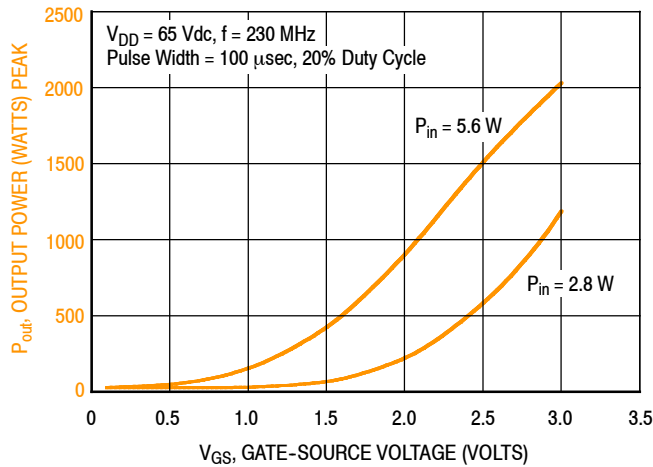
Figure 16. MRFX1K80H Narrowband Test Fixture Component Layout – 230 MHz

Table 11. MRFX1K80H Narrowband Test Fixture Component Designations and Values – 230 MHz

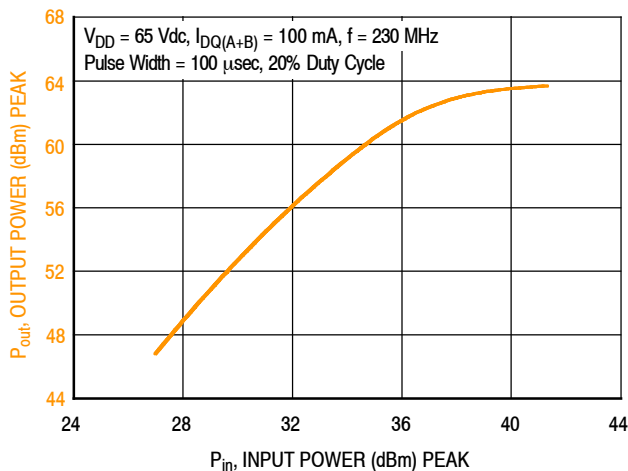
Part	Description	Part Number	Manufacturer
C1, C2, C3	22 pF Chip Capacitor	ATC100B220JT500XT	ATC
C4	27 pF Chip Capacitor	ATC100B270JT500XT	ATC
C5, C6	22 $\mu$ F, 35 V Tantalum Capacitor	T491X226K035AT	Kemet
C7, C9	0.1 $\mu$ F Chip Capacitor	CDR33BX104AKWS	AVX
C8, C10	220 nF Chip Capacitor	C1812C224K5RACTU	Kemet
C11, C12, C24, C25	1000 pF Chip Capacitor	ATC100B102JT50XT	ATC
C13	24 pF Chip Capacitor	ATC800R240JT500XT	ATC
C14, C15, C16	20 pF Chip Capacitor	ATC800R200JT500XT	ATC
C17, C18, C19, C20, C21, C22	240 pF Chip Capacitor	ATC100B241JT200XT	ATC
C23	7.5 pF Chip Capacitor	ATC100B7R5CT500XT	ATC
C26, C27, C28, C29, C30, C31	470 $\mu$ F, 100 V Electrolytic Capacitor	MCGPR100V477M16X32-RH	Multicomp
Coax1, 2, 3, 4	25 $\Omega$ Semi Rigid Coax Cable, 2.2" Shield Length	UT-141C-25	Micro-Coax
L1, L2	5 nH Inductor, 2 Turns	A02TJLC	Coilcraft
L3, L4	6.6 nH Inductor, 2 Turns	GA3093-ALC	Coilcraft
R1, R2	10 $\Omega$ , 1/4 W Chip Resistor	CRCW120610R0JNEA	Vishay
PCB	Arlon AD255A 0.030", $\epsilon_r = 2.55$	D93270	MTL



**TYPICAL CHARACTERISTICS — 230 MHz,  $T_C = 25^\circ\text{C}$   
PRODUCTION TEST FIXTURE**

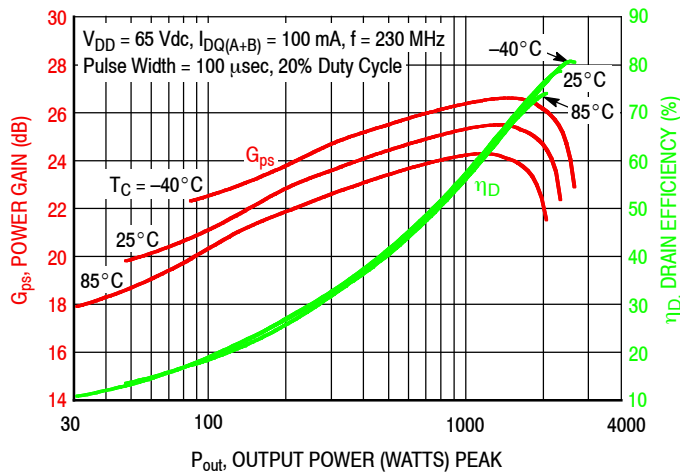


**Figure 17. Output Power versus Gate-Source Voltage at a Constant Input Power**

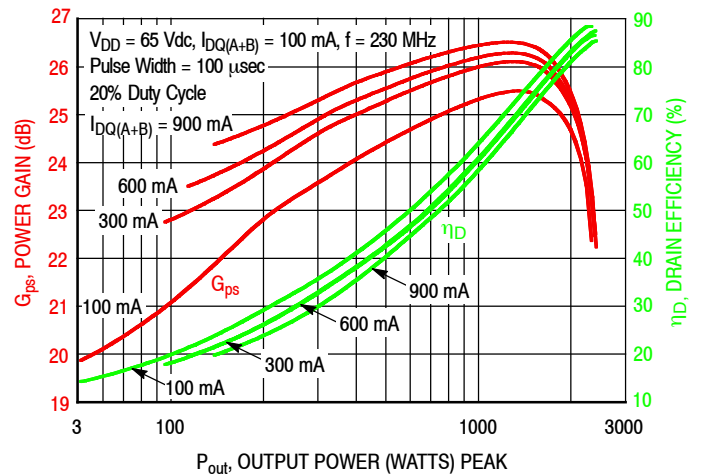


f (MHz)	P1dB (W)	P3dB (W)
230	2080	2300

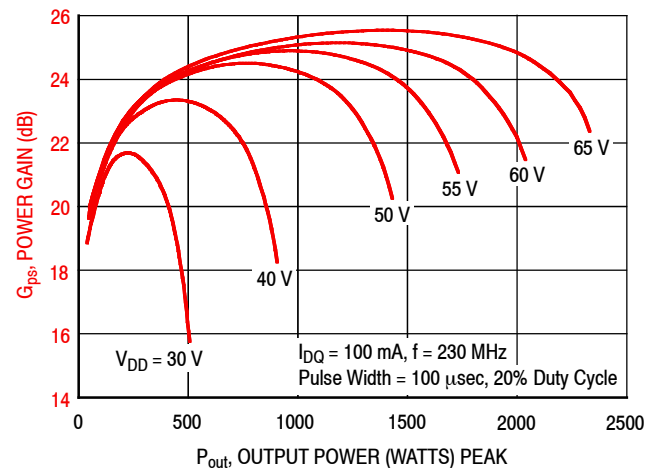
**Figure 18. Output Power versus Input Power**



**Figure 20. Power Gain and Drain Efficiency versus Output Power**



**Figure 19. Power Gain and Drain Efficiency versus Output Power and Quiescent Current**



**Figure 21. Power Gain versus Output Power and Drain-Source Voltage**

## 230 MHZ NARROWBAND PRODUCTION TEST FIXTURE

f MHz	Z <sub>source</sub> Ω	Z <sub>load</sub> Ω
230	1.1 + j2.7	2.2 + j2.9

Z<sub>source</sub> = Test fixture impedance as measured from gate to gate, balanced configuration.

Z<sub>load</sub> = Test fixture impedance as measured from drain to drain, balanced configuration.

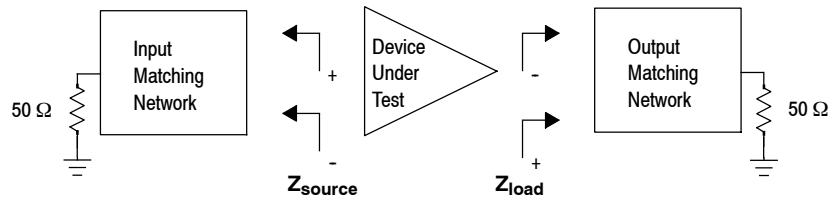
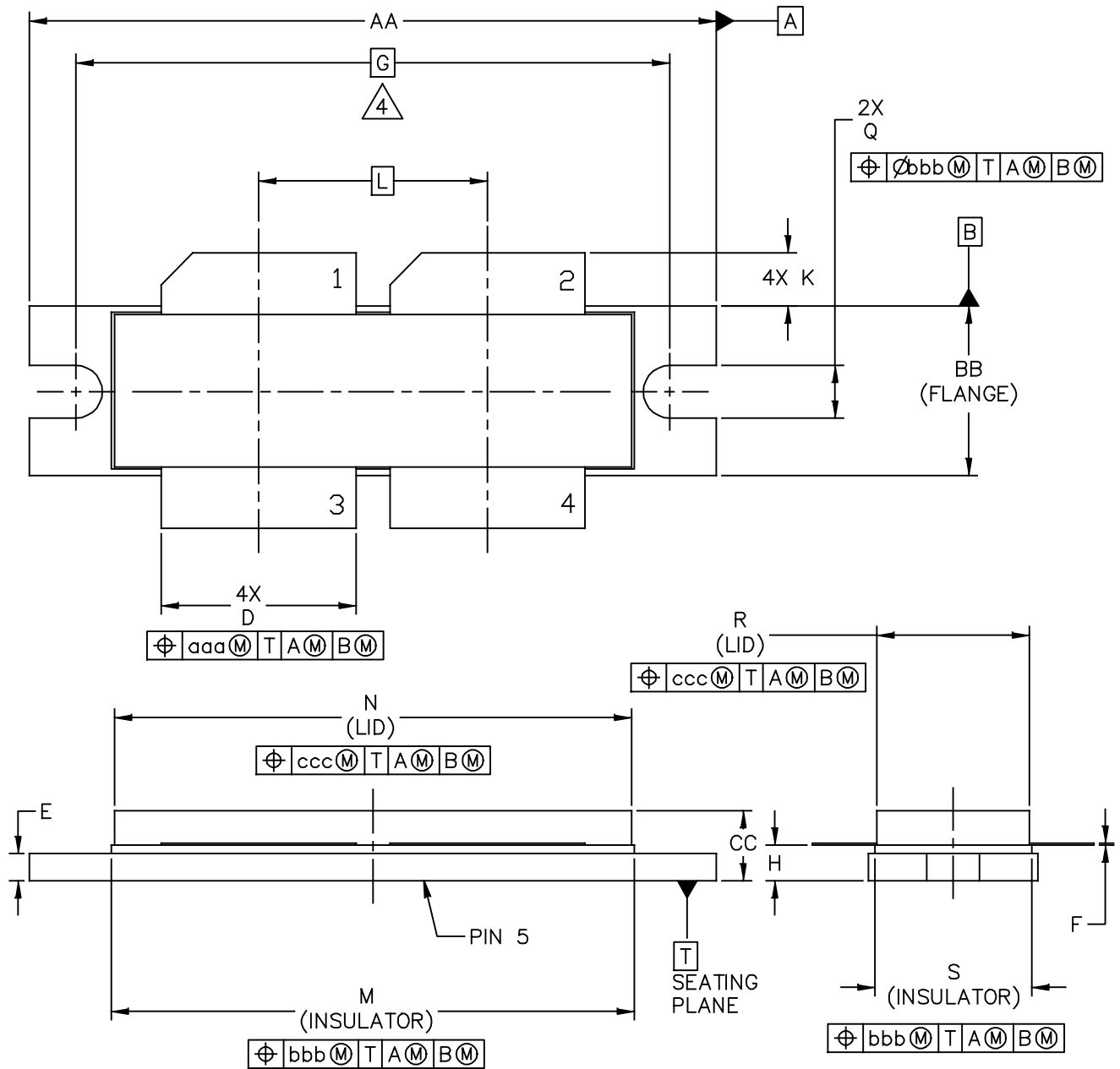


Figure 22. Narrowband Series Equivalent Source and Load Impedance – 230 MHz

### PACKAGE DIMENSIONS



© NXP SEMICONDUCTORS N.V. ALL RIGHTS RESERVED	MECHANICAL OUTLINE	PRINT VERSION NOT TO SCALE
TITLE:  NI-1230-4H	DOCUMENT NO: 98ASB16977C	REV: G
	STANDARD: NON-JEDEC	
	SOT1787-1	03 MAR 2016

NOTES:

1. INTERPRET DIMENSIONS AND TOLERANCES PER ASME Y14.5M-1994.
2. CONTROLLING DIMENSION: INCH
3. DIMENSION H IS MEASURED .030 INCH (0.762 MM) AWAY FROM PACKAGE BODY.

4.  RECOMMENDED BOLT CENTER DIMENSION OF 1.52 INCH (38.61 MM) BASED ON M3 SCREW.

DIM	INCH		MILLIMETER		DIM	INCH		MILLIMETER	
	MIN	MAX	MIN	MAX		MIN	MAX	MIN	MAX
AA	1.615	1.625	41.02	41.28	N	1.218	1.242	30.94	31.55
BB	.395	.405	10.03	10.29	Q	.120	.130	3.05	3.30
CC	.170	.190	4.32	4.83	R	.355	.365	9.02	9.27
D	.455	.465	11.56	11.81	S	.365	.375	9.27	9.53
E	.062	.066	1.57	1.68					
F	.004	.007	0.10	0.18					
G	1.400 BSC		35.56 BSC		aaa	.013		0.33	
H	.082	.090	2.08	2.29	bbb	.010		0.25	
K	.117	.137	2.97	3.48	ccc	.020		0.51	
L	.540 BSC		13.72 BSC						
M	1.219	1.241	30.96	31.52					
© NXP SEMICONDUCTORS N.V. ALL RIGHTS RESERVED			MECHANICAL OUTLINE			PRINT VERSION NOT TO SCALE			
TITLE:  NI-1230-4H					DOCUMENT NO: 98ASB16977C      REV: G				
					STANDARD: NON-JEDEC				
					SOT1787-1			03 MAR 2016	

## PRODUCT DOCUMENTATION, SOFTWARE AND TOOLS

Refer to the following resources to aid your design process.

### Application Notes

- AN1908: Solder Reflow Attach Method for High Power RF Devices in Air Cavity Packages
- AN1955: Thermal Measurement Methodology of RF Power Amplifiers

### Engineering Bulletins

- EB212: Using Data Sheet Impedances for RF LDMOS Devices

### Software

- Electromigration MTTF Calculator
- RF High Power Model
- .s2p File

### Development Tools

- Printed Circuit Boards

### To Download Resources Specific to a Given Part Number:

1. Go to <http://www.nxp.com/RF>
2. Search by part number
3. Click part number link
4. Choose the desired resource from the drop down menu

## REVISION HISTORY

The following table summarizes revisions to this document.

Revision	Date	Description
0	Aug. 2017	<ul style="list-style-type: none"><li>• Initial release of data sheet</li></ul>

## ***How to Reach Us:***

**Home Page:**  
nxp.com

**Web Support:**  
nxp.com/support

Information in this document is provided solely to enable system and software implementers to use NXP products. There are no express or implied copyright licenses granted hereunder to design or fabricate any integrated circuits based on the information in this document. NXP reserves the right to make changes without further notice to any products herein.

NXP makes no warranty, representation, or guarantee regarding the suitability of its products for any particular purpose, nor does NXP assume any liability arising out of the application or use of any product or circuit, and specifically disclaims any and all liability, including without limitation consequential or incidental damages. "Typical" parameters that may be provided in NXP data sheets and/or specifications can and do vary in different applications, and actual performance may vary over time. All operating parameters, including "typicals," must be validated for each customer application by customer's technical experts. NXP does not convey any license under its patent rights nor the rights of others. NXP sells products pursuant to standard terms and conditions of sale, which can be found at the following address: [nxp.com/SalesTermsandConditions](http://nxp.com/SalesTermsandConditions).

NXP and the NXP logo are trademarks of NXP B.V. All other product or service names are the property of their respective owners.

© 2017 NXP B.V.

