

FEATURES

- 10 column × 8 rows port expander, maximum 10 × 8 keypad matrix**
- Rows and columns configurable to keypad, GPI or GPO**
- Dual light sensor inputs**
- I²C interface**
- Auto increment capability**
- 1.8 V and 3.0 V operation for I²C and GPIOs (1.7 V ~ 3.0 V)**
- Interrupt capability**
- ADP5588 evaluation software included**
- On-board reset**
- GPO indicator LEDs**
- GPIO jumper configuration**
- Switches to set GPI levels**

GENERAL DESCRIPTION

The ADP5588 demonstration board is used to exercise the features of the ADP5588 keypad/GPIO expander IC. It consists of a daughterboard and a motherboard. The motherboard houses the keypad (80 switches), a USB connector (JP1), a reset switch (S17), and all the hardware necessary to power the IC and establish USB communication with the PC. Two 20-pin connectors (J11 and J12) are used to plug in the daughterboard. The ADP5588 IC is mounted on the daughterboard along with the LK1 and LK2 jumpers, which are used to insert or remove the C19 and C20 capacitors from the light sensor comparator circuitry.

The demonstration board assembly is powered either via J10 or the USB port and comes with a free graphical user interface (GUI) to exercise the ADP5588 features. In addition to the keypad switches, the motherboard also has 18 GPO LED indicators (D1 through D11, D22 through D27, and D30), power status LEDs (D19 and D21), a 2.7 V regulator, a 3.3 V regulator, and jumpers (J1 through J8 and J13 through J22) to configure the GPIOs as GPIs, GPOs, or keypad lines. The motherboard is equipped with jumpers (LK8 and LK10) to configure the board to use either external regulated voltages via J10 or the on-board regulators when plugged into the USB port. When using the USB port as the power source, place jumpers across Pin 1 and Pin 2 of LK8 and LK10. When using external voltages, place jumpers across Pin 2 and Pin 3 of LK8 and LK10. V_{CC} (Pin 3 of J10) should be 1.8 V to 3.0 V, and V_{BOARD} (Pin 1 of J10) should be 3.3 V.

A set of switches (SW1 through SW18) provides logic high (Logic 1) or logic low (Logic 0) drives to the GPIOs configured as GPIs. Column 8 and Column 9 of the IC have an additional jumper (J9) that allows the user to configure these lines into light sensor comparator inputs. Place a jumper across Pin 1 and Pin 3 of J9 and another across Pin 2 and Pin 4 of J9 to configure these pins as Keypad Column 8 and Keypad Column 9, or place a jumper across Pin 3 and Pin 5 of J9 and another across Pin 4 and Pin 6 of J9 to configure these pins as light sensor inputs.

MOTHERBOARD LAYOUT

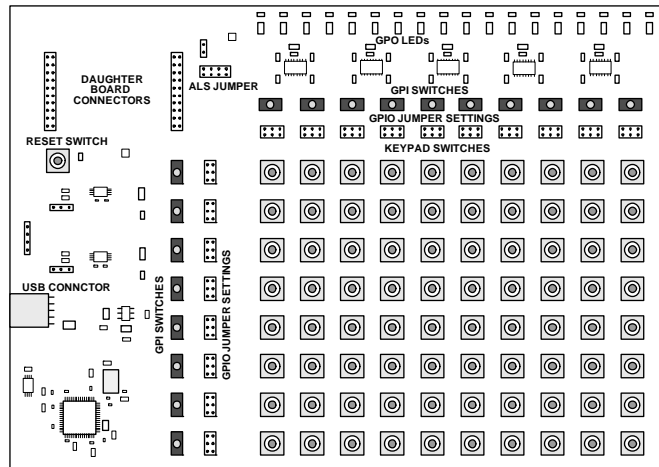

Figure 1.

Rev. 0

Evaluation boards are only intended for device evaluation and not for production purposes. Evaluation boards are supplied "as is" and without warranties of any kind, express, implied, or statutory including, but not limited to, any implied warranty of merchantability or fitness for a particular purpose. No license is granted by implication or otherwise under any patents or other intellectual property by application or use of evaluation boards. Information furnished by Analog Devices is believed to be accurate and reliable. However, no responsibility is assumed by Analog Devices for its use, nor for any infringements of patents or other rights of third parties that may result from its use. Analog Devices reserves the right to change devices or specifications at any time without notice. Trademarks and registered trademarks are the property of their respective owners. Evaluation boards are not authorized to be used in life support devices or systems.

TABLE OF CONTENTS

Features	1	USB Driver Installation	6
General Description	1	Using the Software	7
Motherboard Layout	1	The Application Tabs	7
Revision History	2	Schematics	13
Demonstration Board Assembly	3	Ordering Information	19
Software Installation.....	4	Bill of Materials (BOM).....	19
ADP5588 Evaluation Installation.....	4	Ordering Guide	20
LabVIEW Runtime Engine Installation	5	ESD Caution.....	20

REVISION HISTORY

6/09—Revision 0: Initial Version

DEMONSTRATION BOARD ASSEMBLY

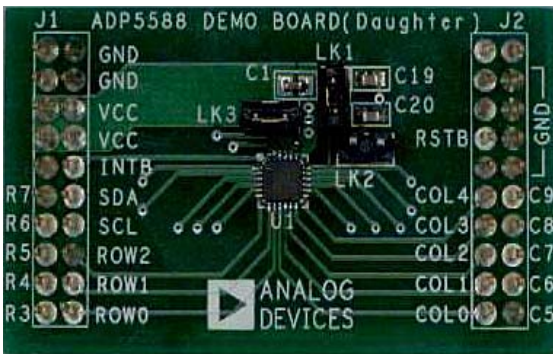

Figure 2. Daughterboard

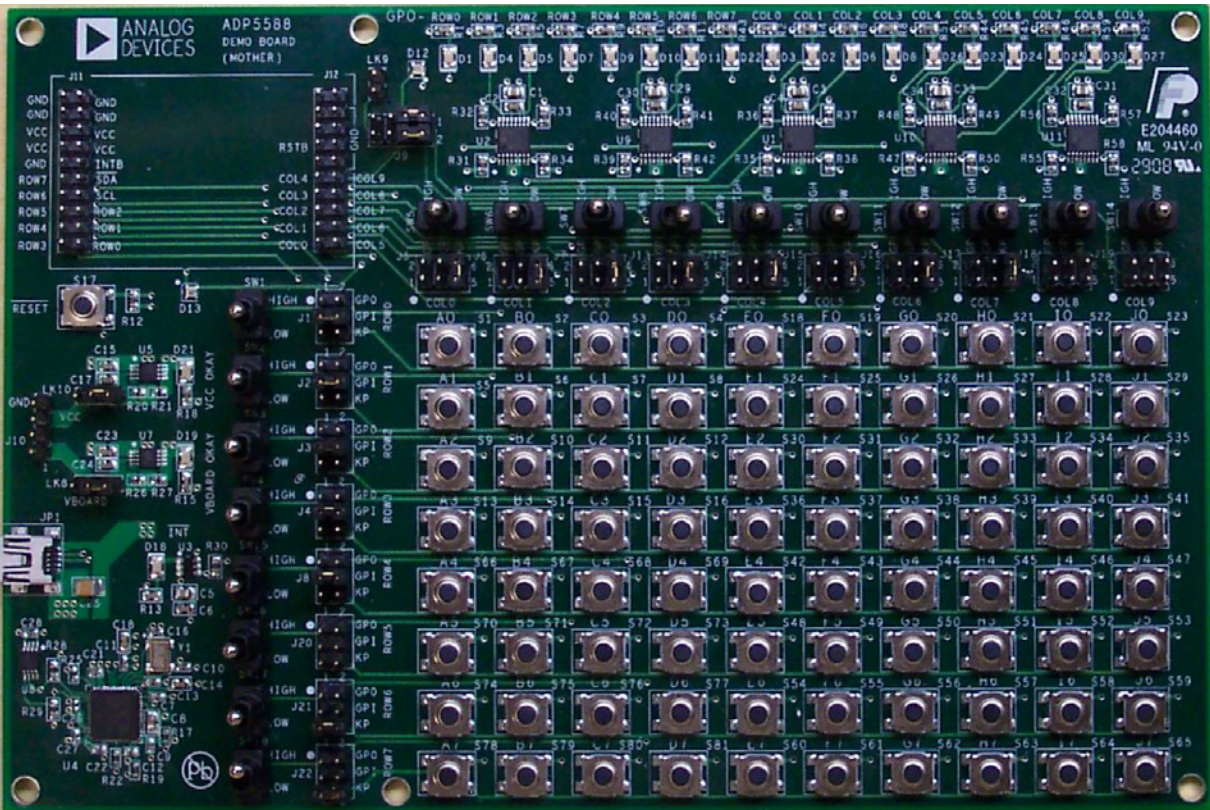

Figure 3. Motherboard

SOFTWARE INSTALLATION

Installation of the LabVIEW_Runtime_Engine.exe file and the ADP5588 GUI is required before using the ADP5588 demonstration board.

ADP5588 EVALUATION INSTALLATION

To run these installations, do the following:

1. Insert the ADP5588 evaluation CD and run the **ADP5588 Setup.exe** file. When the screen in Figure 4 appears, click **Next >**.

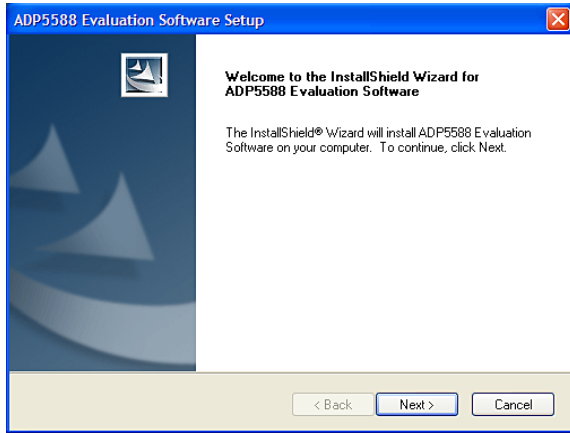

Figure 4. ADP5588 Evaluation Software Setup

2. When the screen in Figure 5 appears, click **Yes** to accept the license agreement.

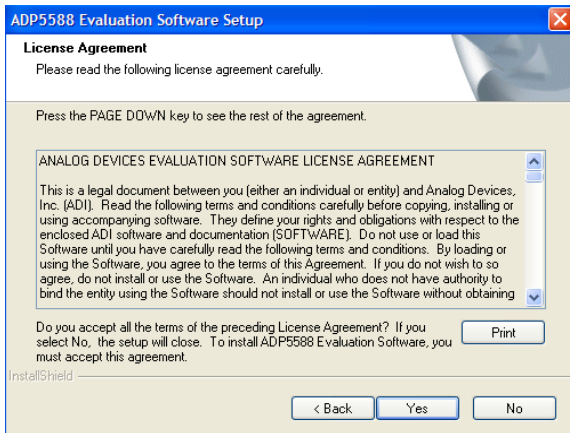

Figure 5. Analog Devices Evaluation Software License Agreement

3. When the screen in Figure 6 appears, click **Next >** to install the files to the default destination folder or browse to choose a different destination.

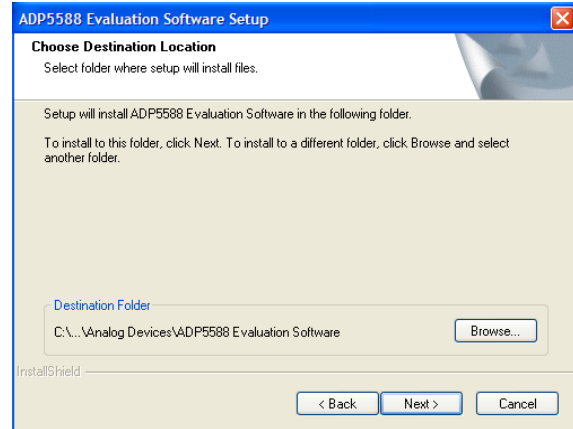

Figure 6. Choose Destination Location

4. When the screen in Figure 7 appears, click **Next >** to continue with installation.

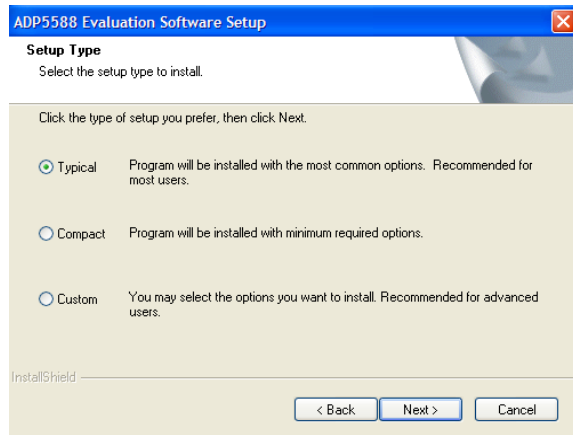

Figure 7. Setup Type

5. When the screen in Figure 8 appears, click **Next >** to add the program icons in the default program folder.

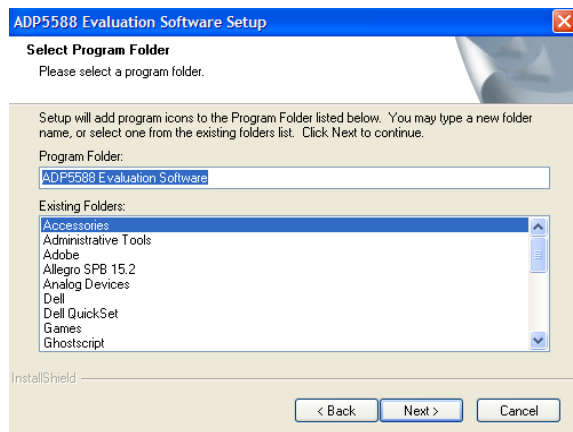

Figure 8. Select Program Folder

6. When the program installation has been completed, click **Finish** to complete the installation (see Figure 9).

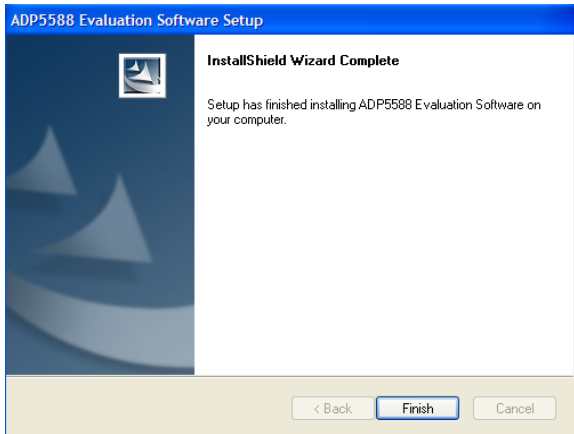

Figure 9. InstallShield Wizard Complete

LABVIEW RUNTIME ENGINE INSTALLATION

The **LabVIEW Runtime Engine** comes as a self-extracting archive and must be unzipped before installation. Version 8.2 or higher is required. To begin installation, do the following:

1. Double click on the **LabVIEW_Runtime_Engine.exe** file. When the dialog box in Figure 10 appears, click **OK** to continue.

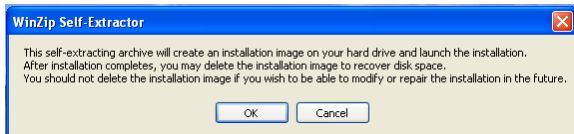

Figure 10. LabVIEW WinZip Self-Extractor

2. When the screen in Figure 11 appears, click **Unzip** to extract the files.

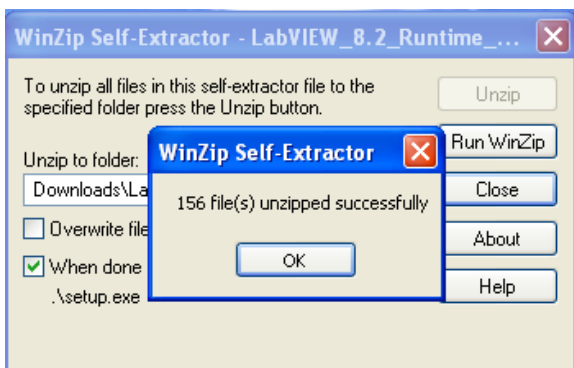

Figure 11. LabVIEW Unzipped Files

3. When the screen in Figure 12 appears, click **Next>>** to start the **NI LabVIEW 8.2 Runtime Engine** installation.



Figure 12. NI LabVIEW 8.2 Runtime Engine Installation

4. When the screen in Figure 13 appears, click **Next >>** to accept the default directory for the installation.

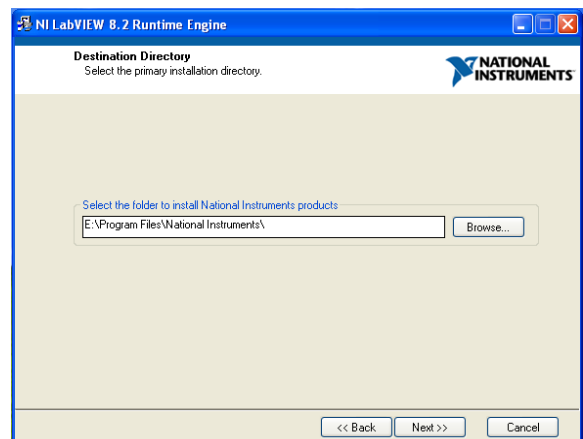

Figure 13. Destination Directory

5. When the screen in Figure 14 appears, click **Next >>** to continue.

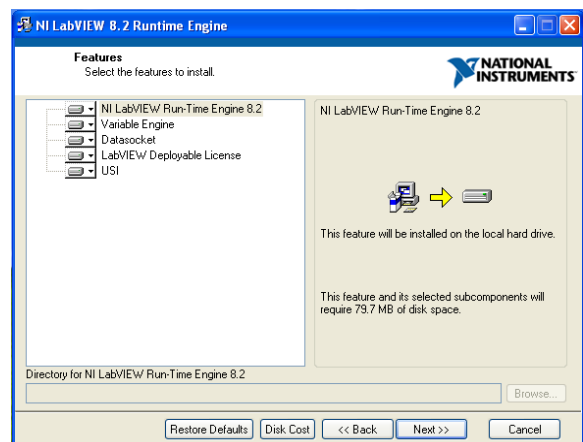

Figure 14. Features Selection

EVAL-ADP5588

6. Select **I accept the License Agreement(s)** and click **Next >>** to continue with the installation (see Figure 15).

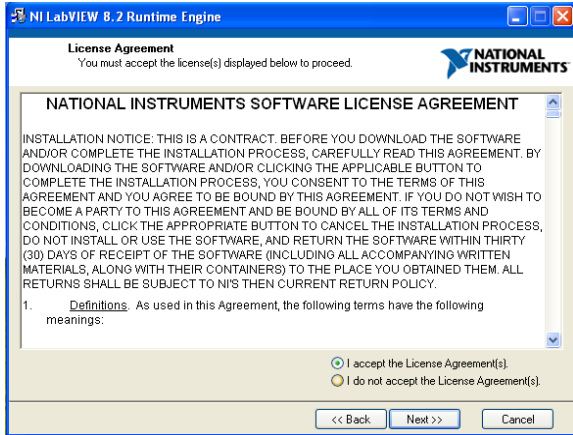

Figure 15. National Instruments Software License Agreement

7. When the screen in Figure 16 appears, click **Next >>** to continue.

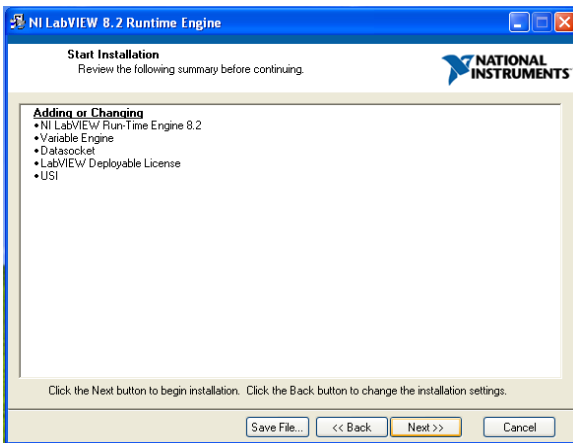

Figure 16. Start Installation (Summary)

8. When the installation is complete, click **Finish** (see Figure 17).

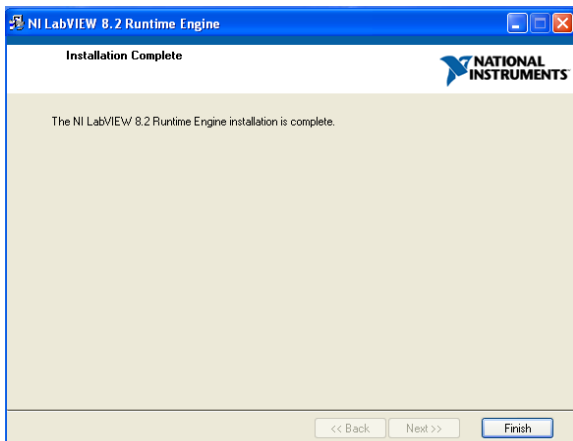

Figure 17. Installation Complete

9. When the screen in Figure 18 appears, click **Restart**. The computer must be restarted to complete installation.

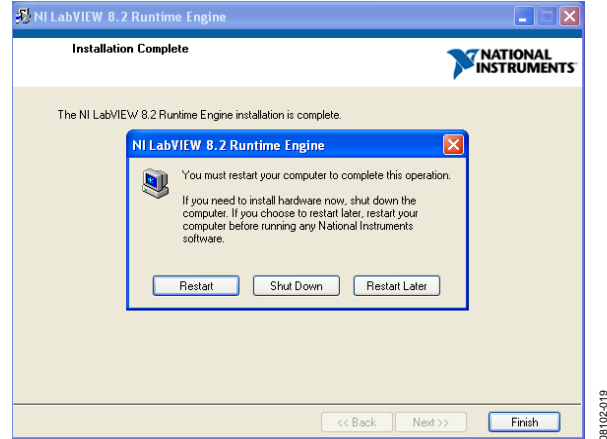

Figure 18. Restart Screen

USB DRIVER INSTALLATION

When the GUI and **LabVIEW Runtime Engine** are installed, assemble the daughterboard onto the motherboard and configure the jumper settings as needed. USB drivers are installed the first time the board assembly is plugged into the USB port after software installation. When assembly is complete, do the following to install the USB drivers.

1. Plug the ADP5588 board into the computer using the provided USB cable. When the system recognizes the board, the screen shown in Figure 19 appears.

Choose **No, not this time** and click **Next >** to install the USB driver.



Figure 19. Found New Hardware Wizard

2. The screen in Figure 20 then appears. Choose **Install the software automatically (Recommended)** and click **Next >**.

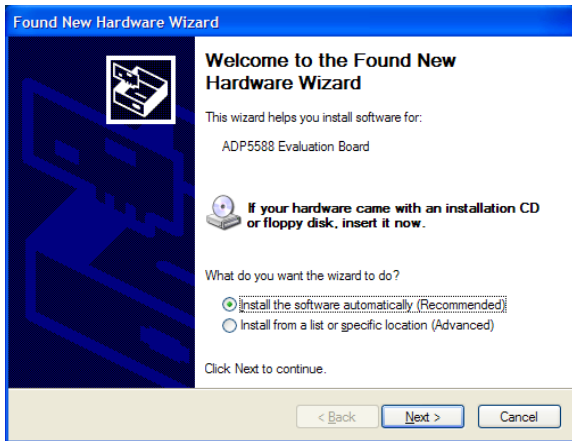

Figure 20. Software Location Installation

3. When the screen in Figure 21 appears, click **Continue Anyway**; this completes the USB driver installation.

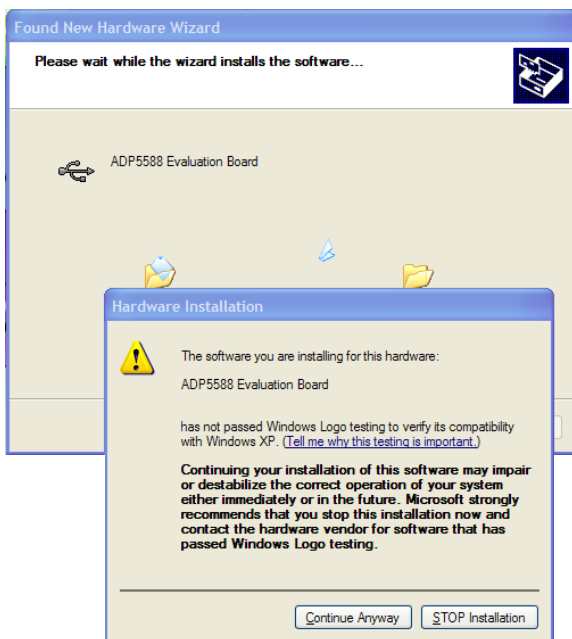

Figure 21. Windows Compatibility Warning

4. When the screen in Figure 22 appears, click **Finish** to complete the USB driver installation.

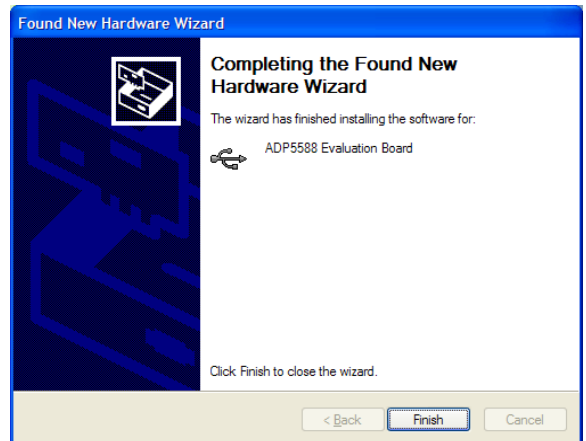

Figure 22. USB Driver Installation Completion

USING THE SOFTWARE

Before running the software, make sure that the ADP5588 board assembly is plugged into the USB port. When it is plugged in properly, the two supply LEDs (D19 and D21) light up. Then click **START>All Programs>Analog Devices>ADP5588Evaluation Software**.

The software then detects the presence of the board USB interface and prints the message **Firmware Downloaded okay** at the bottom left side of the screen (see Figure 23). If USB communication is not established, a **Firmware not Downloaded USB Communication Error** prints instead. If the latter message appears, unplug the board and try it again.

THE APPLICATION TABS

The ADP5588 software application has four tabs: the **Keypad** application tab, the **GPIOs** configuration tab, the **Light-Sensors** configuration tab, and the **History** tab. The **History** tab allows you to record a sequence of commands that can be converted into scripts later on. This is useful during software development.

Register Programming

To program a particular register, click the pertinent SIM LED or tab on the left side of the menu and select the appropriate value. When finished, click **Program 0xXX** to program the register (XX represents the register address to be programmed). When programmed, the value in the register can be read by clicking **Read 0xXX** (XX represents the register address to be read). The interrupt status registers, keypad status registers, and input values can be read the same way.

EVAL-ADP5588

Keypad Configuration

The ADP5588 has eighteen GPIOs that can be programmed as keypad lines to make up a 10 × 8 keypad matrix (80 keys). If a smaller size matrix is needed, the unused GPIOs can be used for other functions (other functions include GPIs, GPOs, and light sensor comparator inputs).

Motherboard Jumper J1 through Motherboard Jumper J8 and Motherboard Jumper J13 through Motherboard Jumper J22 must be set in the KP position in any row or column that will be used as part of the keypad matrix.

For more information, see Figure 32.

To program a GPIO pin as a keypad in the GPIO tab:

1. Set the bits for the columns and rows that need to be configured as keypads in Register 0x1D, Register 0x1E, and Register 0x1F and click **Program 0xXX** for each register that needs to be programmed (XX represent the register address to be programmed).
2. Enable KE interrupt for key presses and releases, if needed, by setting Bit 0 in Register 0x01. Register 0x04 through Register 0x0D make up the FIFO registers for the key event table. For more details on the keypad operations, see the [ADP5588](#) data sheet.

For more information, see Figure 23.

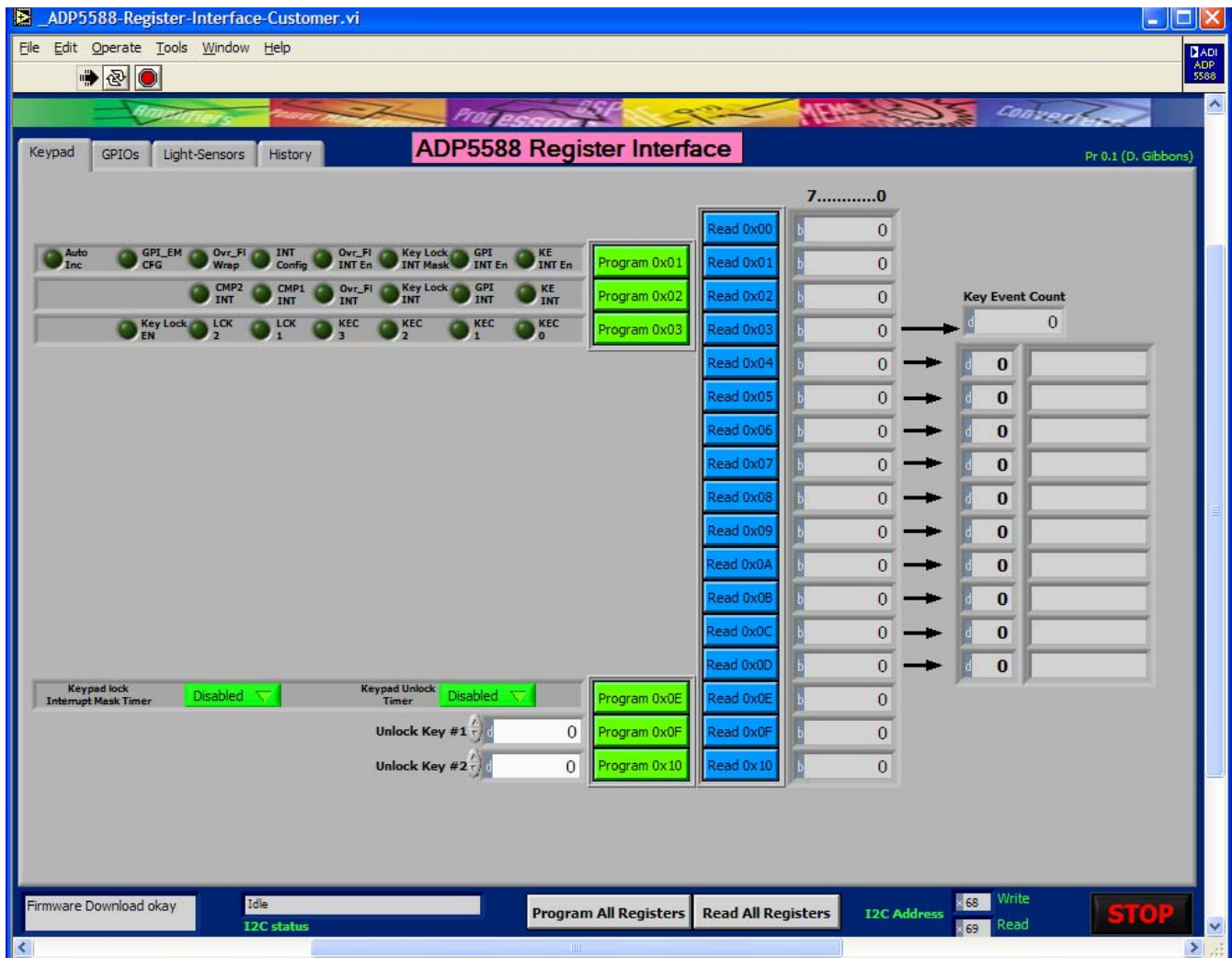

Figure 23. Keypad Configuration Tab



Figure 24. GPIOs Configuration

GPIOs Configuration

The ADP5588 allows the user to configure any of the eighteen GPIOs as GPIs or GPOs (see Figure 24).

Motherboard Jumpers J1 through Motherboard Jumpers J8 and Motherboard Jumpers J13 through Motherboard Jumpers J22 must be set in the GPI or GPO position for any row or column that is to be used as GPI or GPO.

GPI Configuration

To configure a row or column to GPI, do the following:

1. Clear the bit for the row or column to be configured as GPI in Register 0x1D, Register 0x1E, and Register 0x1F.
2. Clear the bit for the row or column to be configured as GPI in Register 0x23, Register 0x24, and Register 0x25.
3. If interrupt triggering is needed, set the GPIO interrupt enable bit for the rows and columns in Register 0x1A, Register 0x1B, and Register 0x1C.

4. Define the trigger level for any of the rows or columns for which interrupt is enabled (Register 0x26 through Register 0x28).
5. Enable **GPIO DEBOUNCE**, if needed, for the rows or columns that are configured as GPIs (Register 0x29 through Register 0x2B).
6. Configure **GPIO PULLUP**, if needed, for the rows or columns that are configured as GPIs (Register 0x2C through Register 0x2E).

Read Register 0x14, Register 0x15, and Register 0x16 to see the **GPIO DATA STATUS**; read Register 0x11, Register 0x12, and Register 0x13 for the **GPIO INTERRUPT STATUS**. Green LEDs at the right side of the GPIOs configuration tab light up to indicate the status of the pins or interrupts.

GPIs can be programmed as part of the event FIFO/key event table, see the [ADP5588](#) data sheet for more details.

GPO Configuration

To GPO configure a row or column, do the following:

1. Clear the bit for the row or column that needs to be configured as a GPO in Register 0x1D, Register 0x1E, and Register 0x1F.
2. Set the bit for the row or column that needs to be configured as a GPO in Register 0x23, Register 0x24, and Register 0x25.
3. Set the drive level for the GPO lines in Register 0x17, Register 0x18, and Register 0x19.

Columns or rows configured as GPO are not read into Register 0x014, Register 0x15, and Register 0x16. The D1 through D11, D22 through D27, and D30 status LED indicate the level of the GPIOs configured as GPOs.

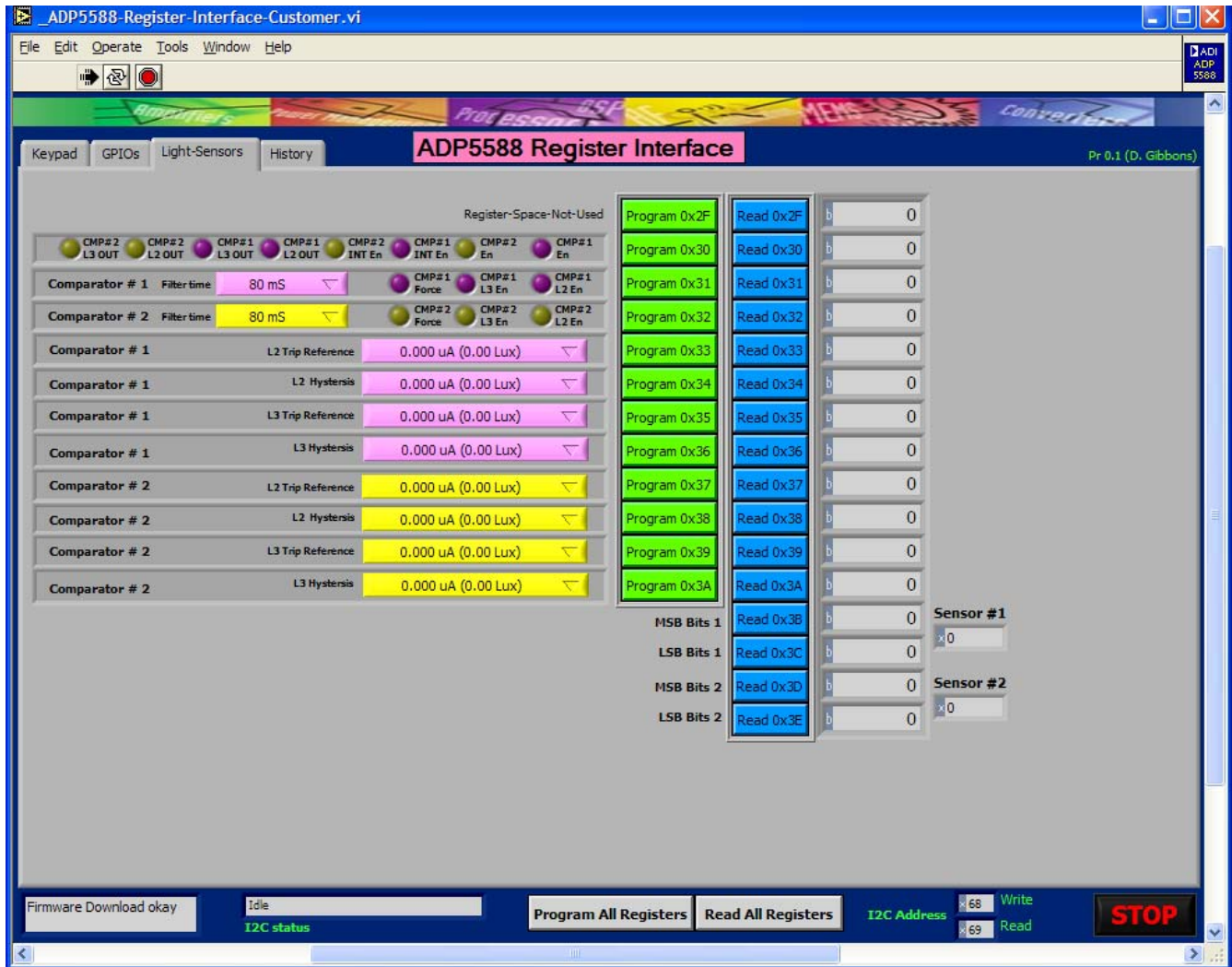

Figure 25. Light Sensors Configuration

Light Sensor Comparator Trip Reference Programming

The ADP5588 is equipped to support two light sensor comparator inputs. Both light sensors (D12 and D13) are mounted on the motherboard (see the layout for the light sensor location in Figure 32).

Use the **Light-Sensors** tab to program the light sensors and comparator parameters. Column 8 and Column 9 are used as the light sensor comparator inputs. When Column 8 and Column 9 are programmed as light sensor comparator inputs, LK1 and LK2 should be placed on the daughterboard. LK1 and LK2 connect C19 and C20 to the comparator inputs; these capacitors are needed for the light sensor comparator operation and should be placed only if Column 8 and/or Column 9 is configured as a light sensor input.

To program Column 8 and Column 9 as light sensor inputs

1. Clear Bit 0 and Bit 1 in Register 0x1F.
2. Set Bit 0 and/or Bit 1 in Register 0x30 to enable Comparator 1 and/or Comparator 2.

3. Set Bit 2 and/or Bit 3 of Register 0x30 to enable interrupt for the comparators, if needed.
4. Set Bit 0 and Bit 1 of Register 0x31 and Register 0x32 to enable the comparator trip points.

Use Register 0x33 through Register 0x3A to set individual comparator trip references and hysteresis.

Trip point values are expressed in μA or lux. Ensure that the right values are picked for the correct lighting environment; the comparator does not trip if the values are not within the brightness range of the lighting environment.

Use the filter time to increase the number of photo sensor readings necessary to trip from one lighting environment to another. The filter time register is programmable from 80 ms minimum to 10.24 sec (see the [ADP5588](#) data sheet for more details on sensor operation).

Comparator **L3 OUT** and Comparator **L2 OUT** are used in conjunction with the force read bits in Register 0x31 and Register 0x32 to determine the photo sensor readings during a force read.

EVAL-ADP5588

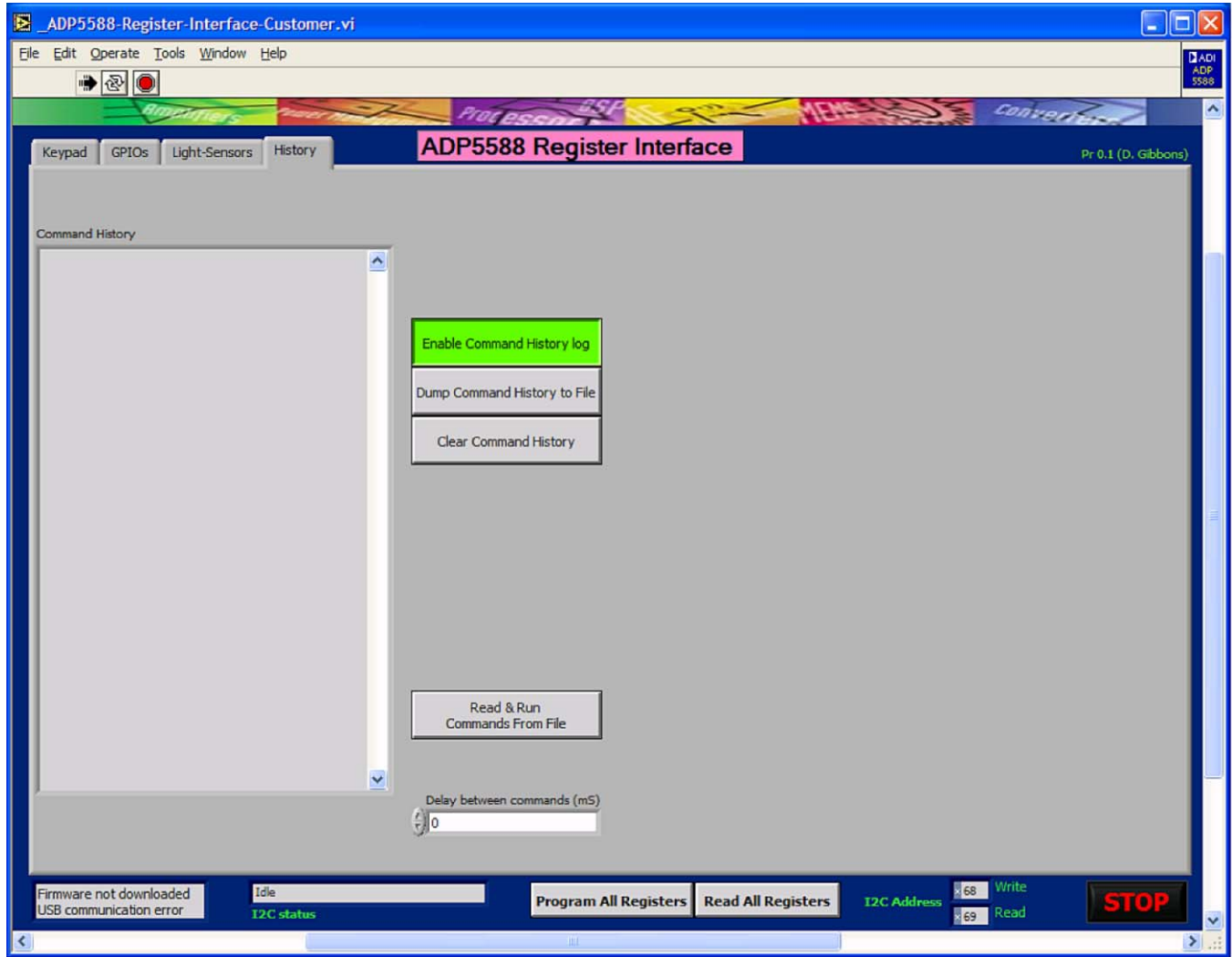

Figure 26. History Tab

History

The **History** tab is used to record command sequences that can be used later as script files.

To start recording commands, click **Enable Command History log**.

When command sequences are recorded, the list of commands can be saved as a script file and later used as input to program all of the registers for a particular configuration or setting.

The script file allows the user to program all the register settings without having to repeat these commands one by one. This feature can be used to automate certain functions that will be used later or repeatedly (useful for software development).

SCHEMATICS

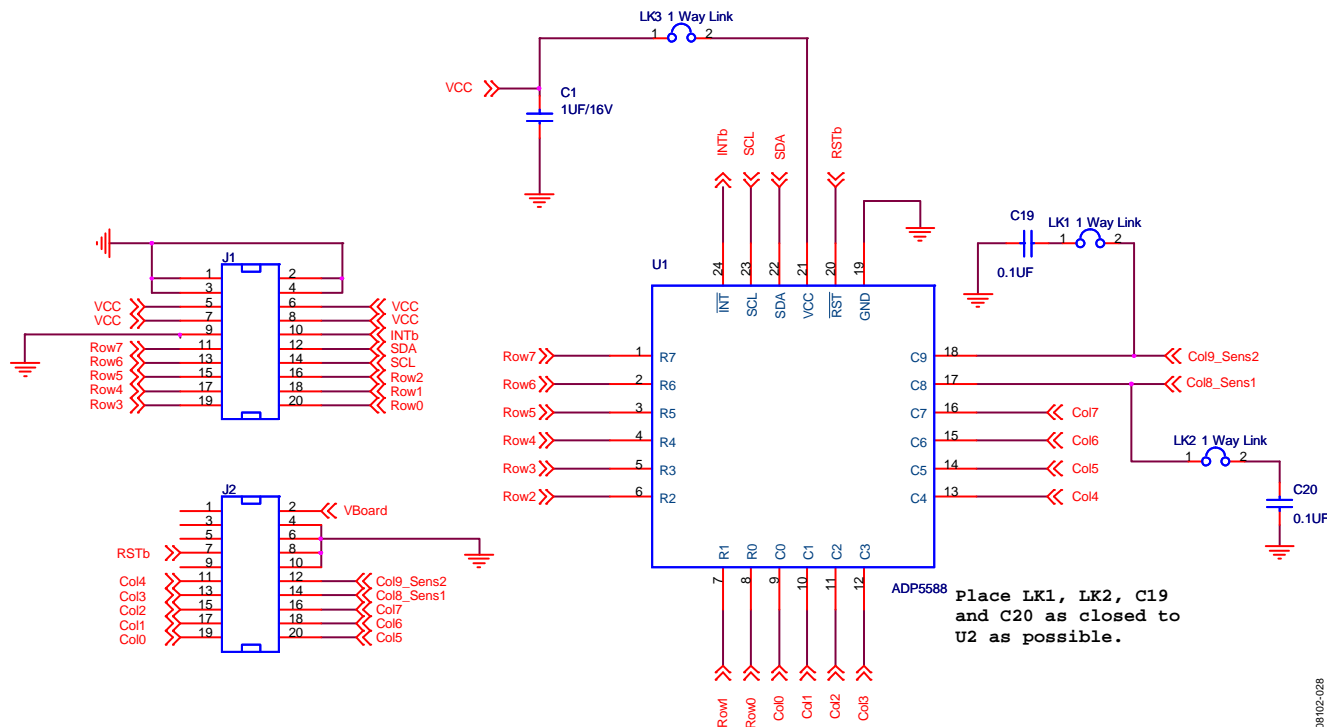

Figure 27. Daughterboard Schematic

08102-028

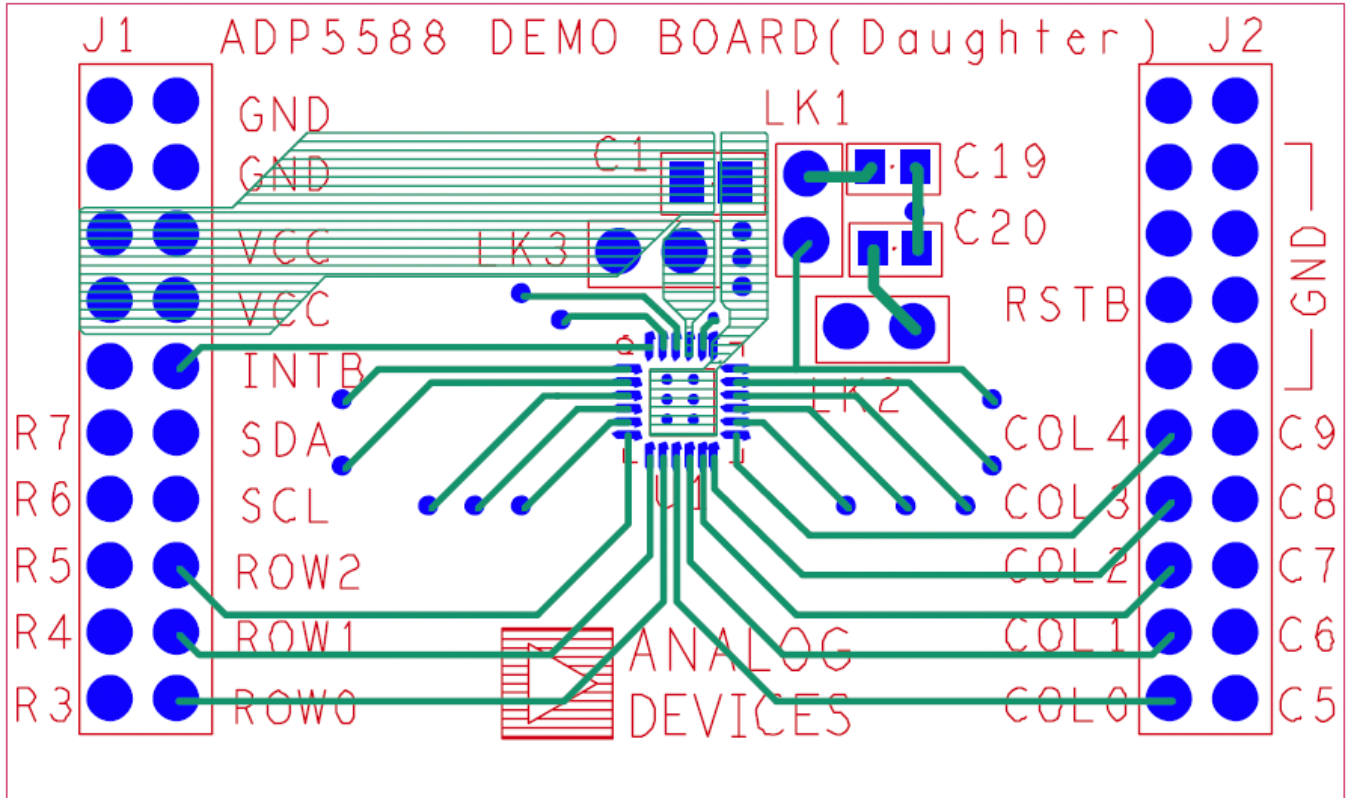

Figure 28. Daughterboard Layout (Top Layer)

08102-229

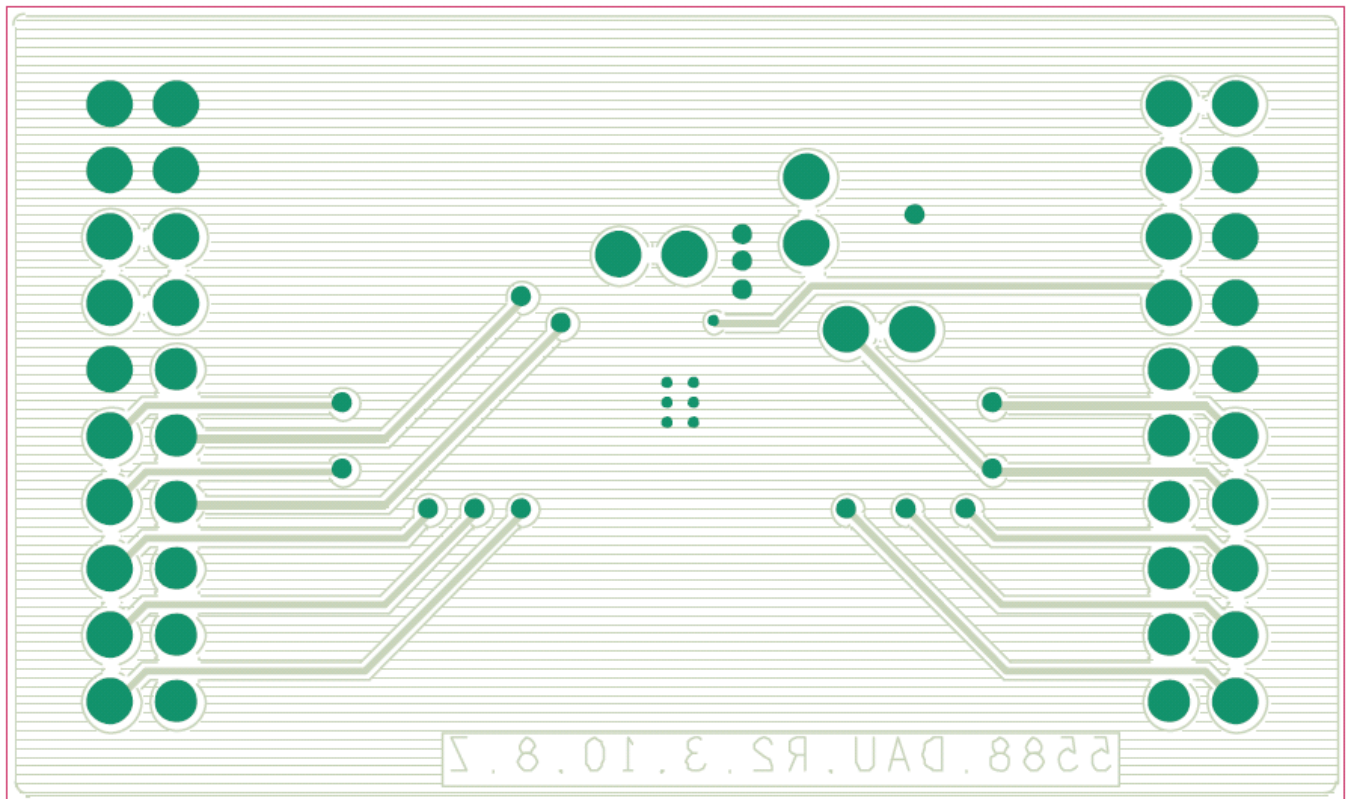

Figure 29. Daughterboard Layout (Bottom Layer)

08102-230

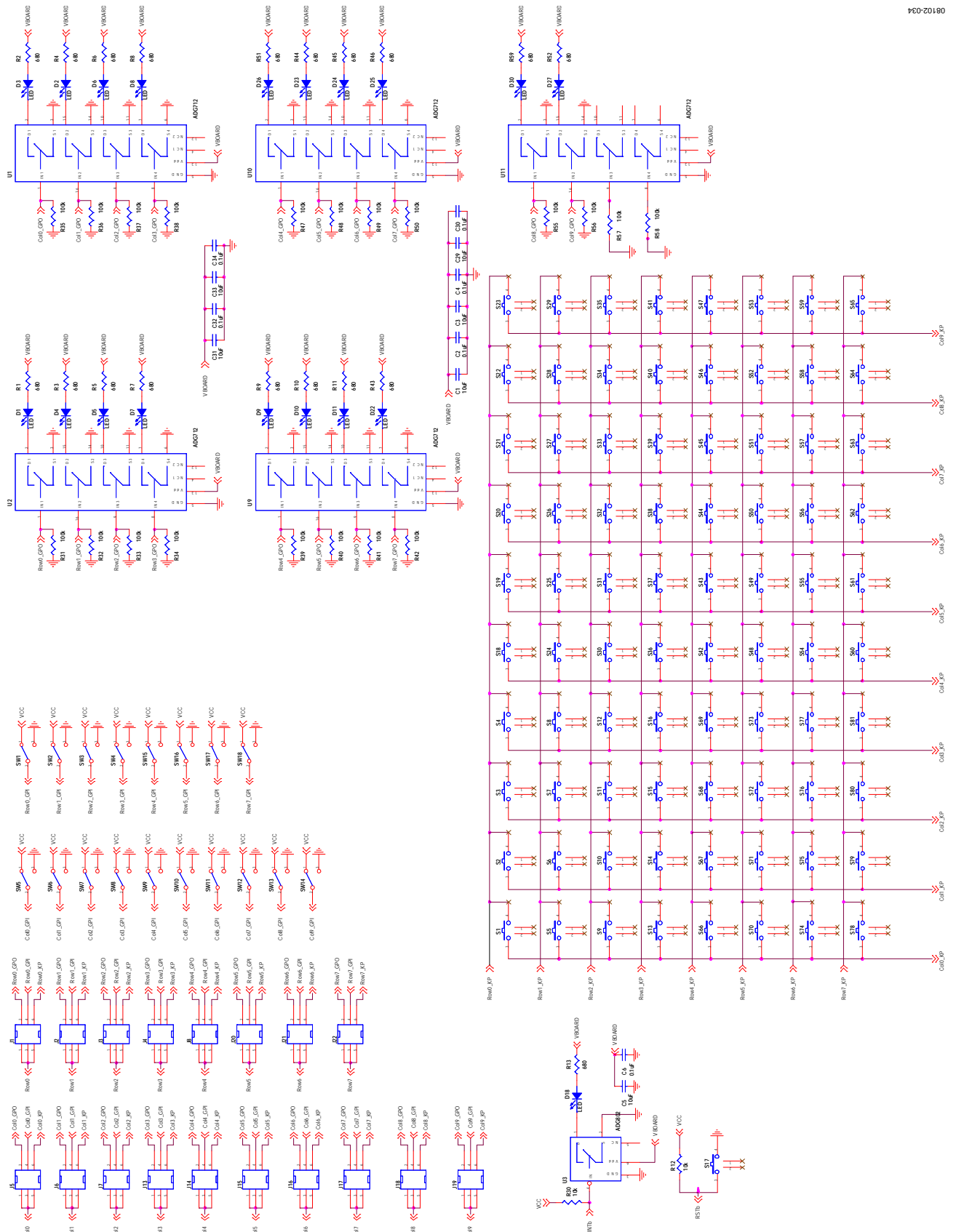

Figure 30. Motherboard Schematic

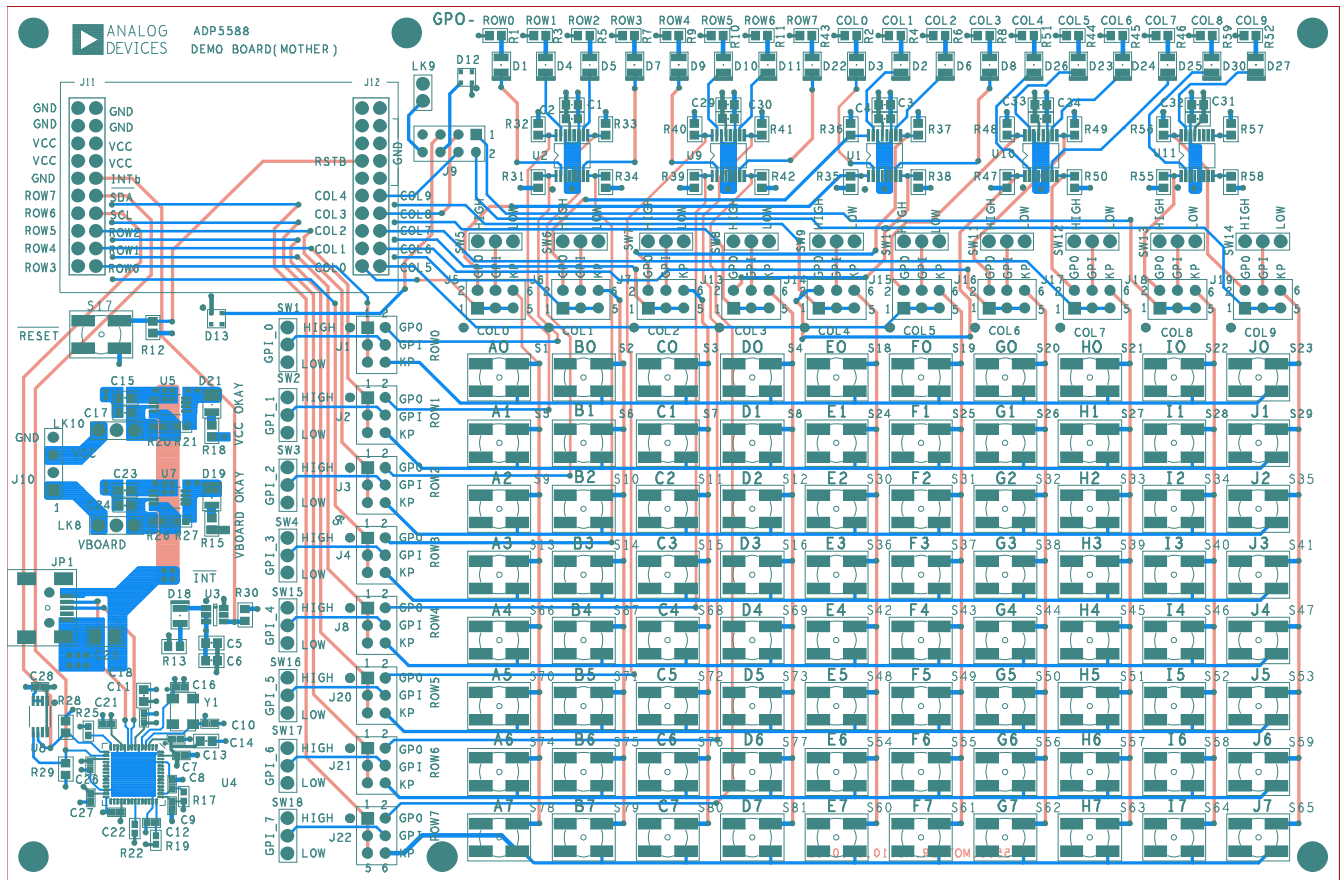

Figure 32. Motherboard Layout (Top Layer)

Table 1. Keypad Translation Table

	Col 0	Col 1	Col 2	Col 3	Col 4	Col 5	Col 6	Col 7	Col 8	Col 9
Row0	1/A0	2/B0	3/C0	4/D0	5/E0	6/F0	7/G0	8/H0	9/I0	10/J0
Row1	11/A1	12/B0	13/C1	14/D1	15/E1	16/F1	17/G1	18/H1	19/I1	20/J1
Row2	21/A2	22/B2	23/C2	24/D2	25/E2	26/F2	27/G2	28/H2	29/I2	30/J2
Row3	31/A3	32/B3	33/C3	34/D3	35/E3	36/F3	37/G3	38/H3	39/I3	40/J3
Row4	41/A4	42/B4	43/C4	44/D4	45/E4	46/F4	47/G4	48/H4	49/I4	50/J4
Row5	51/A5	52/B5	53/C5	54/D5	55/E5	56/F5	57/G5	58/H5	59/I5	60/J5
Row6	61/A6	62/B6	63/C6	64/D6	65/E6	66/F6	67/G6	68/H6	69/I6	70/J6
Row7	71/A7	72/B7	73/C7	74/D7	75/E7	76/F7	77/G7	78/H7	79/I7	80/J7

The keypad on the demonstration board is labeled from A0 through J7, but the application software keys go from 1 to 80. The letters in the key nomenclature denote the columns, and the numbers denote the rows. Therefore, A0 is equivalent to Key 1, and J7 is equivalent to Key 80. Use Table 1 to find the equivalent number key in the software.

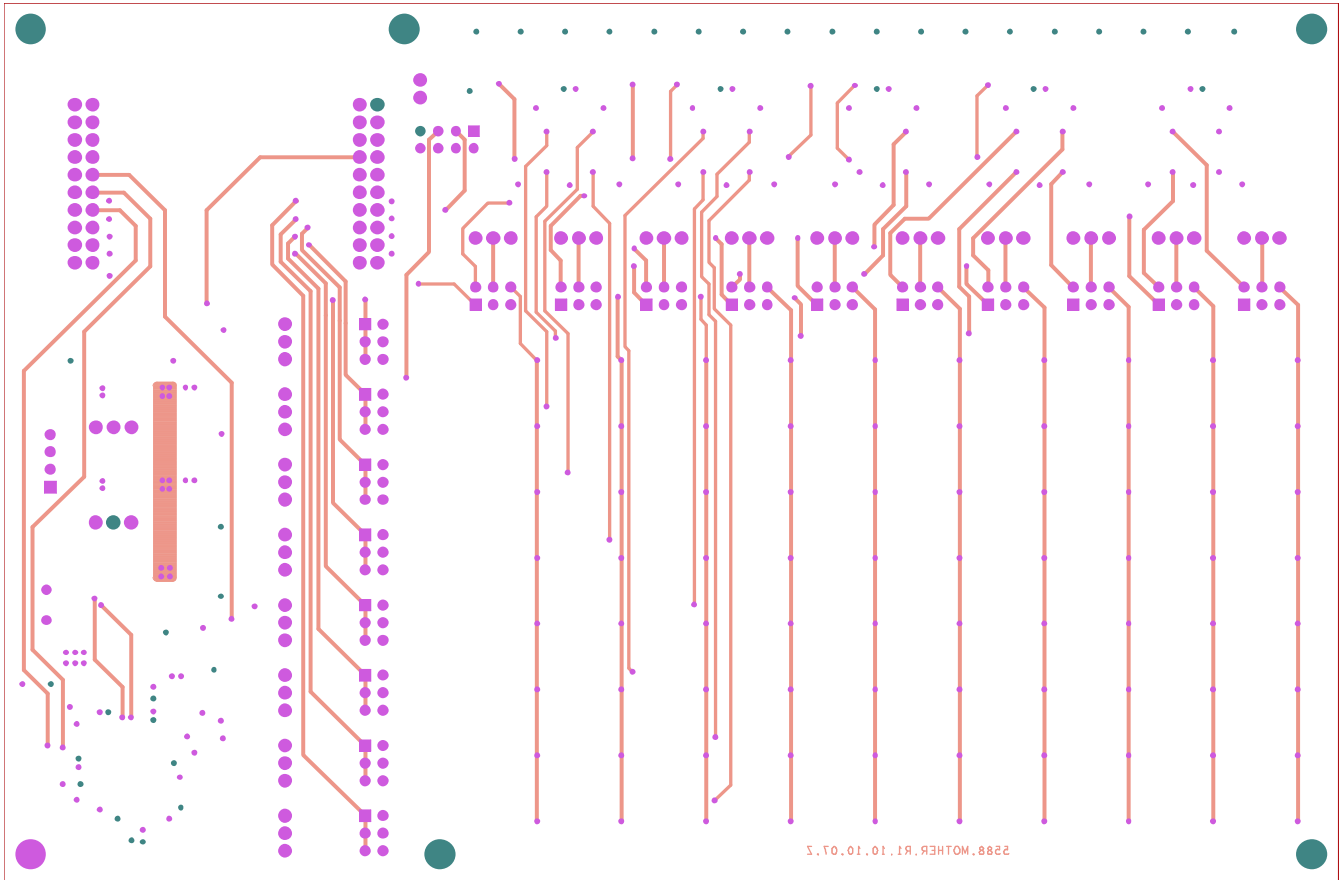

Figure 33. Motherboard Layout (Bottom Layer)

ORDERING INFORMATION

BILL OF MATERIALS (BOM)

Table 2. Daughterboard BOM

Item	Quantity	Reference Designator	Description	Manufacturer/Vendor	Manufacturer Part No.
1	1	U1	ADP5588 IC	Analog Devices	ADP5588ACPZ-RL
2	2	C19, C20	0.1 μ F capacitor	Murata	GRM188R71E104KA01
3	1	C1	1 μ F capacitor	Murata	GRM188R61C105K
4	2	J1, J2	10 \times 2 connector	Samtec	SSW-110-03-G-D
5	3	LK1, LK2, LK3	1-way link	Sullins Connector Solutions	PEC36SAAN

Table 3. Motherboard BOM

Item	Quantity	Reference	Description	Manufacturer/Vendor	Manufacturer Part No.
1	5	R12, R21, R25, R27, R30	Resistor, 10 k Ω , 0402	Vishay	CRCW040210K0FKE
2	7	C1, C3, C5, C8, C29, C31, C33	Capacitor MLCC, 10 μ F, 16 V, 0805, X5R	Murata	GRM21BR61C106K
3	16	C2, C4, C6, C7, C9, C11, C12, C13, C21, C22, C26 to C28, C30, C32, C34	Capacitor MLCC, 0.1 μ F, 16 V, 0603, X5R	Murata	GRM188R61C104KA01B
4	2	C10, C16	Capacitor MLCC, 6.2 pF, 50 V, 0603, X5R	Murata	GRM1885C1H6R2DZ01D
5	6	C14, C15, C17, C18, C23, C24	Capacitor MLCC, 2.2 μ F, 16 V, 0603, X5R	Murata	GRM188R61C225K
6	1	C25	Capacitor MLCC, 47 μ F, 16 V, 1210, X5R	Murata	GRM32ER61C476K
7	22	D1 to D11, D18, D19, D21 to D27, D30	White LED	Lite-On, Inc.	LTW-170TK
8	2	D12, D13	Photo-sensor	Avago Technologies	APDS-9005
9	1	JP1	USB connector	Hirose Electric	UX60-MB-5ST
10	18	J1 to J8, J13 to J22	3 \times 2 connector	Sullins Connector Solutions	PEC36DAAN
11	1	J9	4 \times 2 connector	Sullins Connector Solutions	PEC36DAAN
12	1	J10	4 \times 1 connector	Sullins Connector Solutions	PEC36SAAN
13	2	J11, J12	10 \times 2 connector	Sullins Connector Solutions	PEC36DAAN
14	3	LK8 to LK10	2-way link	Sullins Connector Solutions	PEC36SAAN
15	22	R1 to R11, R13, R15, R18, R43 to R46, R51, R52, R59	Resistor, 681 Ω , 0603	Vishay	CRCW0603681RFKE
16	3	R17, R19, R22	Resistor, 100 k Ω , 0402	Vishay	CRCW0402100KFKE
17	23	R31 to R42, R47 to R50, R55 to R58	Resistor, 100 k Ω , 0603	Vishay	CRCW0603100KFKE
18	1	R20	Resistor, 24.3 k Ω , 0402	Vishay	CRCW040224K3FKE
19	1	R26	Resistor, 31.6 k Ω , 0402	Vishay	CRCW040231K6FKE
20	2	R28, R29	Resistor, 2.21 k Ω , 0805	Vishay	CRCW08052K21FKE
21	18	SW1 to SW18	3-way Switch	APEM Components, Inc.	SW MAG-SPDT
22	81	S1 to S81	Push-button switch	ITT Industries, C&K	SW PUSHBUTTON
23	5	U1, U2, U9 to U11	ADG712	Analog Devices	ADG712BRUZ
24	1	U3	ADG802	Analog Devices	ADG802BRTZ-REEL7
25	1	U4	USB microcontroller	Cypress Semiconductor Corp.	CY7C68013A
26	3	U5, U7	ADP1715	Analog Devices	ADP1715ARMZ-R7
27	1	U8	Serial EEPROM	Microchip	M24C64-R
28	1	Y1	Crystal 24 MHz	CTS, Frequency Controls (VA)	CTX651CT

EVAL-ADP5588

ORDERING GUIDE

Model	Temperature Range
ADP5588-EVALZ ¹	Evaluation Board

¹ Z = RoHS Compliant Part.

ESD CAUTION



ESD (electrostatic discharge) sensitive device. Charged devices and circuit boards can discharge without detection. Although this product features patented or proprietary protection circuitry, damage may occur on devices subjected to high energy ESD. Therefore, proper ESD precautions should be taken to avoid performance degradation or loss of functionality.