



User Manual

ARK-2120

Fanless Embedded Box PC

ADVANTECH

Enabling an Intelligent Planet

Attention!

Please note:

This package contains a hard-copy user manual in Chinese for China CCC certification purposes, and there is an English user manual included as a PDF file on the CD. Please disregard the Chinese hard copy user manual if the product is not to be sold and/or installed in China.

Copyright

The documentation and the software included with this product are copyrighted 2010 by Advantech Co., Ltd. All rights are reserved. Advantech Co., Ltd. reserves the right to make improvements in the products described in this manual at any time without notice.

No part of this manual may be reproduced, copied, translated or transmitted in any form or by any means without the prior written permission of Advantech Co., Ltd. Information provided in this manual is intended to be accurate and reliable. However, Advantech Co., Ltd. assumes no responsibility for its use, nor for any infringements of the rights of third parties, which may result from its use.

Acknowledgements

Award is a trademark of Award Software International, Inc.

VIA is a trademark of VIA Technologies, Inc.

IBM, PC/AT, PS/2 and VGA are trademarks of International Business Machines Corporation.

Intel® and Pentium® are trademarks of Intel Corporation.

Microsoft Windows® is a registered trademark of Microsoft Corp.

RTL is a trademark of Realtek Semi-Conductor Co., Ltd.

ESS is a trademark of ESS Technology, Inc.

UMC is a trademark of United Microelectronics Corporation.

SMI is a trademark of Silicon Motion, Inc.

Creative is a trademark of Creative Technology LTD.

CHRONTEL is a trademark of Chrontel Inc.

All other product names or trademarks are properties of their respective owners.

For more information about this and other Advantech products, please visit our website at:

<http://www.advantech.com/>

<http://www.advantech.com/ePlatform/>

For technical support and service, please visit our support website at:

<http://support.advantech.com.tw/support/>

Product Warranty (2 years)

Advantech warrants to you, the original purchaser, that each of its products will be free from defects in materials and workmanship for two years from the date of purchase.

This warranty does not apply to any products which have been repaired or altered by persons other than repair personnel authorized by Advantech, or which have been subject to misuse, abuse, accident or improper installation. Advantech assumes no liability under the terms of this warranty as a consequence of such events.

Because of Advantech's high quality-control standards and rigorous testing, most of our customers never need to use our repair service. If an Advantech product is defective, it will be repaired or replaced at no charge during the warranty period. For out-of-warranty repairs, you will be billed according to the cost of replacement materials, service time and freight. Please consult your dealer for more details.

If you think you have a defective product, follow these steps:

1. Collect all the information about the problem encountered. (For example, CPU speed, Advantech products used, other hardware and software used, etc.) Note anything abnormal and list any onscreen messages you get when the problem occurs.
2. Call your dealer and describe the problem. Please have your manual, product, and any helpful information readily available.
3. If your product is diagnosed as defective, obtain an RMA (return merchandise authorization) number from your dealer. This allows us to process your return more quickly.
4. Carefully pack the defective product, a fully-completed Repair and Replacement Order Card and a photocopy proof of purchase date (such as your sales receipt) in a shippable container. A product returned without proof of the purchase date is not eligible for warranty service.
5. Write the RMA number visibly on the outside of the package and ship it prepaid to your dealer.

Declaration of Conformity

FCC Class A

Note: This equipment has been tested and found to comply with the limits for a Class A digital device, pursuant to part 15 of the FCC Rules. These limits are designed to provide reasonable protection against harmful interference when the equipment is operated in a commercial environment. This equipment generates, uses, and can radiate radio frequency energy and, if not installed and used in accordance with the instruction manual, may cause harmful interference to radio communications. Operation of this equipment in a residential area is likely to cause harmful interference in which case the user will be required to correct the interference at his own expense.

Technical Support and Assistance

1. Visit the Advantech web site at www.advantech.com/support where you can find the latest information about the product.
2. Contact your distributor, sales representative, or Advantech's customer service center for technical support if you need additional assistance. Please have the following information ready before you call:
 - Product name and serial number
 - Description of your peripheral attachments
 - Description of your software (operating system, version, application software, etc.)
 - A complete description of the problem
 - The exact wording of any error messages

Warnings, Cautions and Notes

Warning! *Warnings indicate conditions, which if not observed, can cause personal injury!*



Caution! *Cautions are included to help you avoid damaging hardware or losing data. e.g.*



There is a danger of a new battery exploding if it is incorrectly installed. Do not attempt to recharge, force open, or heat the battery. Replace the battery only with the same or equivalent type recommended by the manufacturer. Discard used batteries according to the manufacturer's instructions.

Note! *Notes provide optional additional information.*



Packing List

Before installation, please ensure the following items have been shipped:

- 1 x ARK-2120 unit
- 1 x Driver/Utility CD
- 1 x Registration and 2 years Warranty card
- 1 x China RoHS
- 1 x 2-Pole Phoenix to DC-Jack Power cable (F model)

Ordering Information

Model Number	Description
ARK-2120L-S6A1E	Atom N2600 1.6GHz w/ HDMI+VGA+2*GbE+4*COM+6*USB
ARK-2120L-S8A1E	Atom D2550 1.86GHz w/ HDMI+VGA+2*GbE+4*COM+6*USB
ARK-2120F-S6A1E	Atom N2600 1.6GHz w/ HDMI+VGA+LVDS+3*GbE+6*COM
ARK-2120F-S8A1E	Atom D2550 1.86GHz w/ HDMI+VGA+LVDS+3*GbE+6*COM

Optional Accessories

For ARK-2120L

Part Number	Description
1757003553	AC-to-DC Adapter, DC12V/ 3A 36W, with DC Jack, 0 ~ 40-x C for Home and Office Use
1700001524	Power Cable 3-pin 180 cm, USA Type
170203183C	Power Cable 3-pin 180 cm, Europe Type
170203180A	Power Cable 3-pin 180 cm, UK Type
1700008921	Power Cable 3-pin 180 cm, PSE Mark
9666K10000E	DIN-rail mounting kit
1960025333N00N	VESA mounting kit

For ARK-2120F

Part Number	Description
1757003659	AC-to-DC Adapter, DC19 V/3.42 A 65 W, with Phoenix Power Plug, 0 ~ 40° C for Home and Office Use
1700001947	Power cable 2-pin 180 cm, USA for ARK-338X
1700001948	Power cable 2-pin 180 cm, Europe for ARK-338X
1700001949	Power cable 2-pin 180 cm, UK for ARK-338X
1700009001	2-Pole Phoenix to DC-Jack Power cable
9666K10000E	DIN-rail mounting kit
1960025333N00N	VESA mounting kit

Safety Instructions

1. Please read these safety instructions carefully.
2. Please keep this User's Manual for later reference.
3. Please disconnect this equipment from AC outlet before cleaning. Use a damp cloth. Don't use liquid or sprayed detergent for cleaning. Use moisture sheet or clothe for cleaning.
4. For pluggable equipment, the socket-outlet shall near the equipment and shall be easily accessible.
5. Please keep this equipment from humidity.
6. Lay this equipment on a reliable surface when install. A drop or fall could cause injury.
7. The openings on the enclosure are for air convection hence protecting the equipment from overheating. **DO NOT COVER THE OPENINGS.**
8. Make sure the voltage of the power source when connecting the equipment to the power outlet.
9. Place the power cord such a way that people cannot step on it. Do not place anything over the power cord.
10. All cautions and warnings on the equipment should be noted.
11. If the equipment is not used for long time, disconnect the equipment from mains to avoid being damaged by transient over-voltage.
12. Never pour any liquid into ventilation openings; this could cause fire or electrical shock.
13. Never open the equipment. For safety reasons, only qualified service personnel should open the equipment.
14. If one of the following situations arises, get the equipment checked by service personnel:
 - The power cord or plug is damaged.
 - Liquid has penetrated into the equipment.
 - The equipment has been exposed to moisture.
 - The equipment does not work well, or you cannot get it to work according to the user's manual.
 - The equipment has been dropped and damaged.
 - The equipment has obvious signs of breakage.
15. Do not leave this equipment in an environment where the storage temperature may go below -40°C (-40°F) or above 85°C (185°F). This could damage the equipment. the equipment should be in a controlled environment.
16. Caution: Danger of explosion if battery is incorrectly replaced. Replace only with the same or equivalent type recommended by the manufacturer, discard used batteries according to the manufacturer's instructions.
17. The sound pressure level at the operator's position according to IEC 704-1:1982 is no more than 70 dB (A).
18. **RESTRICTED ACCESS AREA:** The equipment should only be installed in a Restricted Access Area.
19. **DISCLAIMER:** This set of instructions is given according to IEC 704-1. Advan-tech disclaims all responsibility for the accuracy of any statements contained herein.

Contents

Chapter 1 General Introduction1

1.1	Introduction	2
1.2	Product Features.....	3
	1.2.1 General	3
	1.2.2 Display	3
	1.2.3 Ethernet	3
1.3	Chipset.....	4
	1.3.1 Functional Specification	4
	1.3.2 iManager	5
1.4	Mechanical Specifications.....	6
	1.4.1 Dimensions	6
	Figure 1.1 ARK-2120 Mechanical dimension drawing.....	6
	1.4.2 Weight.....	6
1.5	Power Requirement	6
	1.5.1 System Power.....	6
	1.5.2 RTC Battery	6
1.6	Environment Specification.....	7
	1.6.1 Operating Temperature.....	7
	1.6.2 Relative Humidity	7
	1.6.3 Storage Temperature.....	7
	1.6.4 Vibration during Operation	7
	1.6.5 Shock during Operation	7
	1.6.6 Safety.....	7
	1.6.7 EMC	7

Chapter 2 H/W Installation.....9

2.1	Introduction	10
2.2	Jumpers	10
	2.2.1 Jumper Description	10
	2.2.2 Jumper List	11
	Table 2.1: Jumper List of Main Board.....	11
	2.2.3 Jumper Location	11
	Figure 2.1 Jumper layout (Component Side).....	11
	Figure 2.2 Jumper layout (Solder Side)	12
	2.2.4 Jumper Setting.....	12
2.3	Connectors.....	13
	2.3.1 ARK-2120 External I/O Connectors	13
	Figure 2.3 ARK-2120L IO connectors drawing	13
	Figure 2.4 ARK-2120F IO connectors drawing.....	14
	Figure 2.5 COM connector	14
	Table 2.2: COM Connector Pin Assignments.....	15
	Figure 2.6 Ethernet connector	15
	Table 2.3: Ethernet Connector Pin Assignments.....	15
	Figure 2.7 Audio connector.....	16
	Table 2.4: Audio Connector Pin Assignments	16
	Figure 2.8 DIO Connector (ARK-2120L).....	16
	Table 2.5: DIO Connector Pin Assignments (ARK-2120L).....	16
	Figure 2.9 DIO connector (ARK-2120F)	17
	Table 2.6: DIO Connector Pin Assignments (ARK-2120F).....	17
	Figure 2.10 USB connector	17
	Table 2.7: USB Connector.....	17
	Figure 2.11 VGA Connector	18
	Table 2.8: VGA Connector Pin Assignments.....	18

	Figure 2.12 Power Input Connector (ARK-2120L).....	18
	Figure 2.13 Compatible dimension of DC Plug for ARK-2120L...	18
	Figure 2.14 Power Input Connector (ARK-2120F)	19
	Table 2.9: Power connector Pin Assignments (ARK-2120F)	19
	Figure 2.15 Power Button.....	19
	Figure 2.16 LED Indicators.....	19
	Figure 2.17 LVDS Connector	19
	Table 2.10: LVDS Connector Pin Assignment	20
	Figure 2.18 LCD Backlight connector.....	20
	Table 2.11: LCD Backlight Connector Pin Assignment.....	20
2.4	Installation.....	21
2.4.1	HDD Installation.....	21
2.4.2	Memory Installation.....	22
2.4.3	CFast Installation.....	24

Chapter 3 BIOS Settings 27

3.1	BIOS Setup.....	28
	Figure 3.1 Setup program initial screen.....	28
3.2	Entering Setup.....	28
3.3	Main Setup.....	29
	Figure 3.2 Main setup screen	29
3.3.1	System date / System time	29
3.4	Advanced BIOS Features Setup.....	30
	Figure 3.3 Advanced BIOS features setup screen	30
3.4.1	Advantech BIOS Update V1.3	30
3.4.2	ACPI Settings	31
	Figure 3.4 ACPI Setting.....	31
3.4.3	TPM Configuration.....	32
	Figure 3.5 TPM Configuration	32
3.4.4	CPU Configuration.....	32
	Figure 3.6 CPU Configuration	32
3.4.5	SATA Configuration.....	33
	Figure 3.7 SATA Configuration.....	33
3.4.6	Intel Fast Flash Standby.....	34
	Figure 3.8 Intel Fast Flash Standby.....	34
3.4.7	USB Configuration.....	34
	Figure 3.9 USB Configuration.....	34
3.4.8	Embedded Controller Configuration	35
	Figure 3.10 Embedded Controller Configuration	35
3.4.9	Super I/O Configuration	36
	Figure 3.11 Super IO Configuration.....	36
3.4.10	AOAC Configuration	37
	Figure 3.12 AOAC Configuration.....	37
3.4.11	PPM Configuration.....	37
	Figure 3.13 PPM Configuration	37
3.5	Chipset Configuration	38
	Figure 3.14 Chipset Setup.....	38
3.5.1	Host Bridge/Intel IGD Configuration	39
	Figure 3.15 Intel IGD Configuration.....	39
3.5.2	South Bridge	40
	Figure 3.16 South Bridge.....	40
	Figure 3.17 TPT Device.....	40
3.6	Boot Settings.....	41
	Figure 3.18 Boot Setup Utility.....	41
3.7	Security Setup.....	42
	Figure 3.19 Password Configuration	42
3.8	Save & Exit	43
	Figure 3.20 Save & Exit.....	43

3.8.1	Save Changes and Exit	43
3.8.2	Discard Changes and Exit	43
3.8.3	Save Changes and Reset	43
3.8.4	Discard Changes and Reset	43
3.8.5	Save Changes	43
3.8.6	Discard Changes	44
3.8.7	Restore Defaults	44
3.8.8	Save User Defaults	44
3.8.9	Restore User Defaults.....	44
3.8.10	Boot Override.....	44

Appendix A Watchdog Timer Sample Code.....45

A.1	EC Watchdog Timer sample code	46
-----	-------------------------------------	----

Chapter 1

General Introduction

This chapter gives background information on ARK-2120 series.

1.1 Introduction

ARK-2120, an intelligent, fanless embedded system powered by Intel® Atom™ N2600/D2550 Dual Core low power processor with rich I/O interfaces. The new generation Intel® Atom™ processor brings 44% improvement on processing power and 90% on graphics performance than previous generation Intel® Atom™ processor. These low-power platforms provide energy-efficient and environmentally responsible solutions, and serve applications targeted at factory automation, machine automation, kiosks, and self-service applications; they operate reliably in -20 ~ 60° C environments!

Rugged & Multifunctional Design

ARK-2120 is powered by Intel® Atom™ N2600 1.6GHz/D2550 1.86GHz dual core processors in an Advantech, rugged-design embedded box PC. All models are fanless, and highlight various quality features including wide-input power supplies from 12V to 24V, wide temperature range -20 ~ 60° C, diverse expandability options, and structural strengthening. ARK-2120 enlarges the surface of the top cover and conductive cylinder to create maximum cooling effects for optimized cooling efficiency. It also provides rich I/O interfaces: up to 6 x USBs, 3 x GbEs, 6 x COMs, and supports high capacity 2.5" HDD up to 1 TB. The RS-232/422/485 COM port mode can easily be changed via BIOS setting.

Multiple Display Support

ARK-2120 supports multiple display types: VGA, HDMI or 48-bit LVDS display. The graphic engine is DirectX 9, H/W format decode/Acceleration, MPEG2 (H/W acceleration), H.264/ VC1/ WMV9 (H/W Decode/Acceleration). ARK-2120 supports dual independent display.

Built in Intelligent Management Tools - Advantech iManager & SUSIAccess

Advantech iManager provides a valuable suite of programmable APIs such as multi-level watchdog, hardware monitor, system restore, and more user-friendly interfaces. iManager is an intelligent self-management cross platform tool that monitors system status for problems and takes action if anything is abnormal. iManager offers a boot up guarantee in critical, low temperature environments so systems can automatically recover when voltages dip. iManager makes the whole system more reliable and more intelligent.

ARK-2120 also supports Advantech's own SUSIAccess, which provides easy remote management so users can monitor, configure, and control a large number of terminals to make maintenance and system recovery simpler.

1.2 Product Features

1.2.1 General

- **CPU:** Intel® Atom™ Processor N2600 1.6GHz/D2550 1.86GHz
- **System Chipset:** Intel® Atom™N2600/D2550 + NM10
- **BIOS:** AMI 16 Mbit Flash BIOS
- **System Memory:** One DDRIII SODIMM. DDRIII 1066 MHz (D2550) or DDRIII 800 MHz (D2600) up to 4 GB
- **Watchdog Timer:** Single chip Watchdog 255-level interval timer, setup by software
- **I/O Interface:**
 - 3 x RS232, 1 x RS232/422/485 (for ARK-2120L)
 - 2 x RS-232, 4 x RS-232/422/485 (for ARK-2120F)
- **USB:**
 - 6 x USB 2.0 compliant ports (for ARK-2120L)
 - 5 x USB 2.0 compliant ports (for ARK-2120F)
- **Audio:** High Definition Audio(HD), Line-in, Line out, Mic-in
- **DIO:** 8-bit general purpose input/output
- **Storage:** 1 x Cfast and 1 x high capacity 2.5" SATA HDD (up to 12.5mm height)
- **Expansion Interface:** Supports 1 x Mini-PCI with SIM holder
- **Software API:** Advantech iManager and SUSIAccess - Remote Device Management technology

1.2.2 Display

- **Controller:** Intel® Atom™ N2600 / D2550
- **Resolution:**
 - VGA: Supports up to 1920 x 1200
 - HDMI: Supports up to 1920 x 1200 @ 60Hz, Supports HDMI 1.31, Max data rate up to 1.65Gb/s
 - LVDS: Supports 48-bit LVDS, up to 2560 x 1600 (ARK-2120F only)
- **Dual Display:**
 - VGA+HDMI, VGA+LVDS, HDMI+LVDS

1.2.3 Ethernet

- **Chipset:**
 - LAN1 Intel 82583V,
 - LAN2 Intel 82583V
 - LAN3 Intel 82583V (ARK-2120F only)
- **Speed:** 1000 Mbps
- **Interface:** 3 x RJ45
- **Standard:** Compliant with IEEE 802.3, IEEE 802.3u, IEEE 802.3x, IEEE 802.3y, IEEE 802.ab.

1.3 Chipset

1.3.1 Functional Specification

1.3.1.1 Processor

Processor	Intel® Atom™ Processor N2600/D2550 Intel® Atom™ N2600 at 1.6GHz /D2550 at 1.86 GHz with 1MB L2 cache Manufacturing Technology:32nm
Memory	Intel® N2600/D2550 Supports DDR3 667 MHz up to 4 GB 1 x 204-pin SODIMM socket type
VGA Memory	Up to 512MB of dynamic video memory allocation

1.3.1.2 Chipset

Internal Graphics Features	<ul style="list-style-type: none">■ DirectX 9 and OpenGL 3.0■ Display Poart 1.1, HDMI 1.3a■ Supports HDCP 1.3■ Intel Display Power saving technology 6.0■ SGXS45 Power VR Core 400/640 MHz
Video Accelerator	<ul style="list-style-type: none">■ H/W accelerated video decode■ Video decoder: Support MPEG4, VC1, WMV9, H.264■ Supports DVD, Blu-ray, and HD video
SATA Interface	Intel® NM10 chip supports: <ul style="list-style-type: none">■ Supports the Serial ATA specification Revision 1.0a■ Supports several optional sections of Serial ATA II: Extensions to Serial ATA 1.0 Specification, Revision 1.0■ Supports SATA transfers to 300 Mbytes/sec.■ Supports Cfast socket
USB Interface	Intel® NM10 chip supports: <ul style="list-style-type: none">■ USB host interface with support for 6 USB 2.0 ports■ All ports are High-Speed, Full-Speed, and Low-Speed capable■ Supports legacy keyboard/mouse software
Power Management	Intel® NM10 chip supports: <ul style="list-style-type: none">■ APM1.2, ACPI supports■ Power state: S0, S3, S4, S5
BIOS	Intel® NM10 chip supports: <ul style="list-style-type: none">■ AMI 16Mb Flash BIOS via SPI

1.3.1.3 Others

	<p>ITE 8760E supports:</p> <ul style="list-style-type: none"> ■ Up to 6 serial ports by ITE 8760. ■ Support IRQ Sharing among serial ports under Microsoft Windows OS
Serial ports	<p>ARK-2120L</p> <ul style="list-style-type: none"> ■ COM1, COM3, COM4: Supports to RS-232 ■ COM2: Supports to RS-232/422/485. Setting by jumper and RS-422/485 cable. <p>** COM2 RS-485 support Auto flow control.</p> <p>ARK-2120F</p> <ul style="list-style-type: none"> ■ COM1, COM2: Supports to RS-232 ■ COM3 ~ COM6: Supports to RS-232/422/485 and change mode under BIOS setting <p>** COM3 ~ COM5 RS-485 support Auto flow control.</p> <p>COM connector: D-SUB CON. 9P</p>
Ethernet	<p>LAN1 Intel 82583V, LAN2 Intel 82583V LAN3 Intel 82583V (ARK-2120F only)</p> <ul style="list-style-type: none"> ■ Compliant with IEEE 802.3, IEEE 802.3u, IEEE 802.3x, IEEE 802.3y, IEEE 802.ab. ■ Support 10/100/1000 Mbps. <p>LAN Connectors: Phone Jack RJ45 8P 90D(F)</p>
Audio	<p>Audio Codec: Realtek ALC892:</p> <ul style="list-style-type: none"> ■ Compliant with HD Audio specifications ■ Supports to 16/20/24-bit DAC and 16/20/24-bit ADC resolution ■ Support: Speak-out, Line-in, Mic-in <p>Audio Connectors: Ear Phone Jack * 3</p>
DIO	<p>ITE 8518E supports:</p> <ul style="list-style-type: none"> ■ 10 I/O pins with one 5V power ping and one ground pin ■ 5V tolerance I/Os. <p>DIO Connectors:</p> <ul style="list-style-type: none"> ■ ARK-2120L: 9 pins DSUB 9 connector ■ ARK-2120F: 10 pins phoenix connector
Battery backup	<ul style="list-style-type: none"> ■ BATTERY 3V/210 mAh with WIRE x 1

1.3.2 iManager

iManager	
Sequence control	Supported
DIO	8-bit programmable DIO
Watchdog timer	Multi Level WDT (set by Advantech iManager) Programmable 1-255 sec / min
Hardware monitor	CPU Temperature / input Current / input Voltage
Power saving	Deep sleep S5 mode / Smart Fan / Back light control
System information	Running HR / Boot record

1.4 Mechanical Specifications

1.4.1 Dimensions

264.5[10.41] x 68.4[2.69] x 133.0[5.2] Unit: mm [Inch]

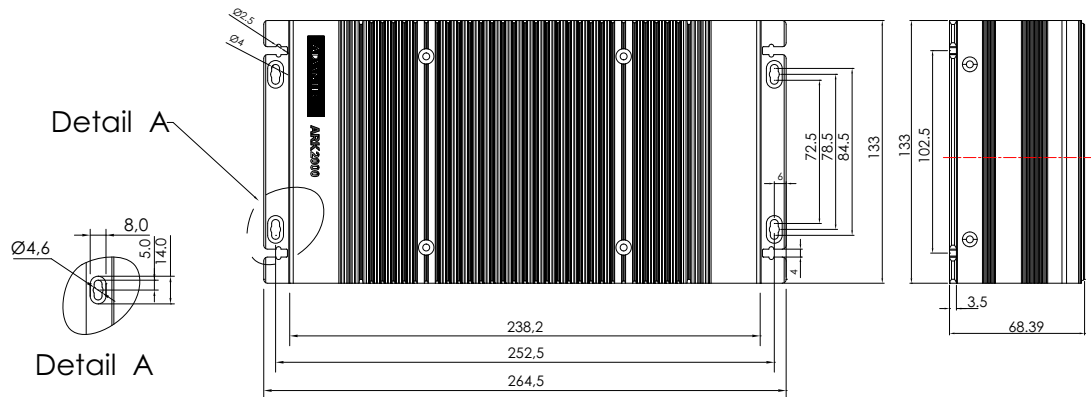

Figure 1.1 ARK-2120 Mechanical dimension drawing

1.4.2 Weight

2.5 kg (5.51 lb)

1.5 Power Requirement

1.5.1 System Power

- **Minimum power input:**
 - ARK-2120L: DC12 V 3 A
 - ARK-2120F: DC12 V - 24 V, 3 A - 1.5 A

1.5.2 RTC Battery

- Lithium 3 V/210 mA

1.6 Environment Specification

1.6.1 Operating Temperature

- With Industrial Grade SSD/Cfast: -20 ~ 60° C (-4~140° F), with air flow, speed=0.7 m/sec
- With 2.5-inch hard disk 0 to 45° C (32~113° F), with air flow, speed=0.7 m/sec

1.6.2 Relative Humidity

- 95% @ 40° C (non-condensing)

1.6.3 Storage Temperature

- -40 ~ 85° C (-40 ~ 185° F)

1.6.4 Vibration during Operation

- When system is equipped with SSD/Cfast: 5Grms, IEC 60068-2-64, random, 5 ~ 500 Hz, 1hr/axis, x,y,z 3 axes.

1.6.5 Shock during Operation

- When system is equipped with SSD/Cfast: 50G, IEC 60068-2-27, half sine, 11 ms duration.

1.6.6 Safety

- UL, CCC, BSMI

1.6.7 EMC

- CE, FCC, CCC, BSMI

Chapter 2

H/W Installation

This chapter introduces external IO and the installation of ARK-2120 hardware.

2.1 Introduction

The following sections show the internal jumpers setting and the external connectors pin assignment for application.

2.2 Jumpers

2.2.1 Jumper Description

You may configure the ARK-2120 to match the needs of your application by setting jumpers. A jumper is a metal bridge used to close an electric circuit. It consists of two metal pins and a small metal clip (often protected by a plastic cover) that slides over the pins to connect them. To close a jumper, you connect the pins with the clip. To open a jumper, you remove the clip. Sometimes a jumper will have three pins, labeled 1, 2 and 3. In this case you would connect either pins 1 and 2, or 2 and 3.

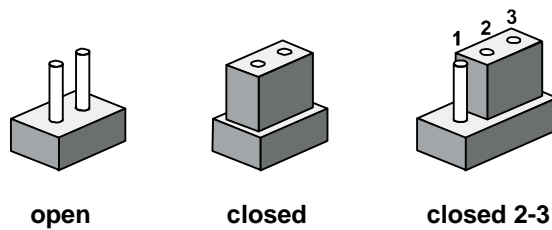

The jumper settings are schematically depicted in this manual as follows.

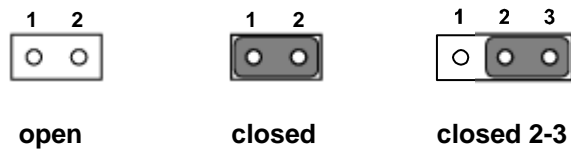

A pair of needle-nose pliers may be helpful when working with jumpers. If you have any doubts about the best hardware configuration for your application, contact your local distributor or sales representative before you make any changes. Generally, you simply need a standard cable to make most connections.

2.2.2 Jumper List

Table 2.1: Jumper List of Main Board

J2	48-bit LVDS Power (F version only)
J3	Auto Power on setting
J4	COM2 Setting (F version only)
J6	Clear CMOS

2.2.3 Jumper Location

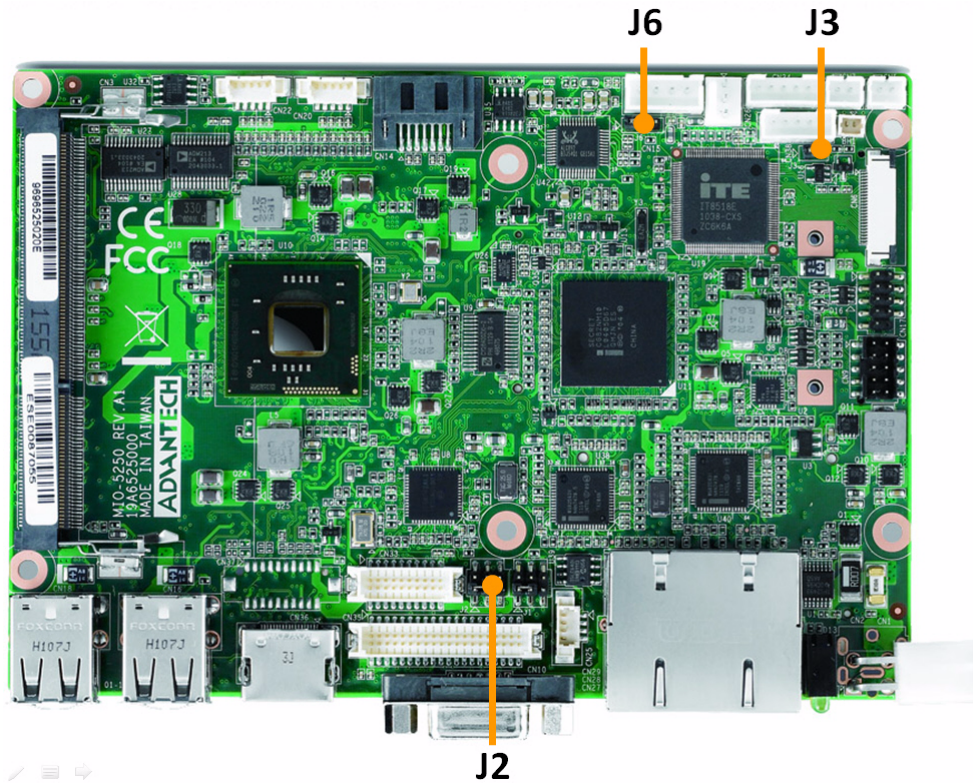

Figure 2.1 Jumper layout (Component Side)

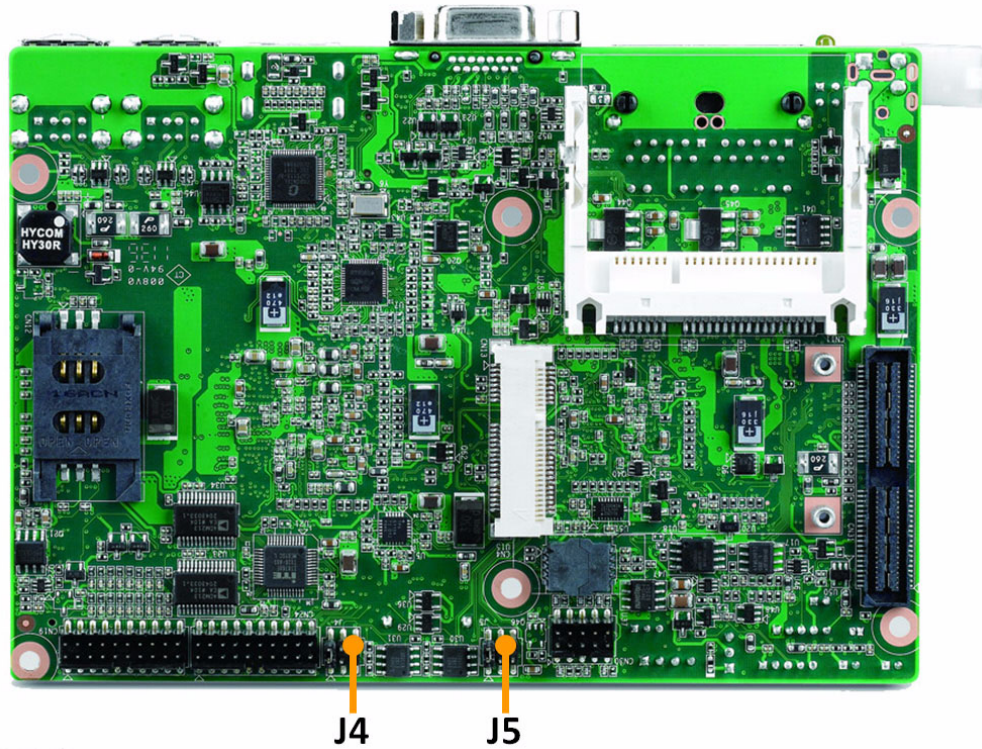

Figure 2.2 Jumper layout (Solder Side)

2.2.4 Jumper Setting

At Mother Board

J2	48 bits LVDS2 Power
Part Number	1653003260
Footprint	HD_3x2P_79
Description	PIN HEADER 3*1P 180D(M) 2.0mm SMD SQUARE PIN
Setting	Function
(1-3)*	+3.3V (default)
(3-5)	+5V
(3-4)	+12V
J3	Auto Power On Setting
Part Number	1653002101
Footprint	HD_3x2P_79_D
Description	PIN HEADER 2*1P 180D(M)SQUARE 2.0mm DIP W/O Pb
Setting	Function
NL	Power On by power button
(1-2)*	Auto Power On (default)

J4	COM2 Setting
Part Number	1653003260
Footprint	HD_3x2P_79
Description	PIN HEADER 3x2P 2.0mm 180D(M) SMD 21N22050
Setting	Function
(1-2)*	RS-232 (default)
(3-4)	RS-485
(5-6)	RS-422

J6	Clear CMOS
Part Number	1653003101
Footprint	HD_3x1P_79_D
Description	PIN HEADER 3x1P 2.0mm 180D(M) DIP 2000-13 WS
Setting	Function
(1-2)*	Normal (default)
(2-3)	Clear COMS

2.3 Connectors

2.3.1 ARK-2120 External I/O Connectors

ARK-2120L:

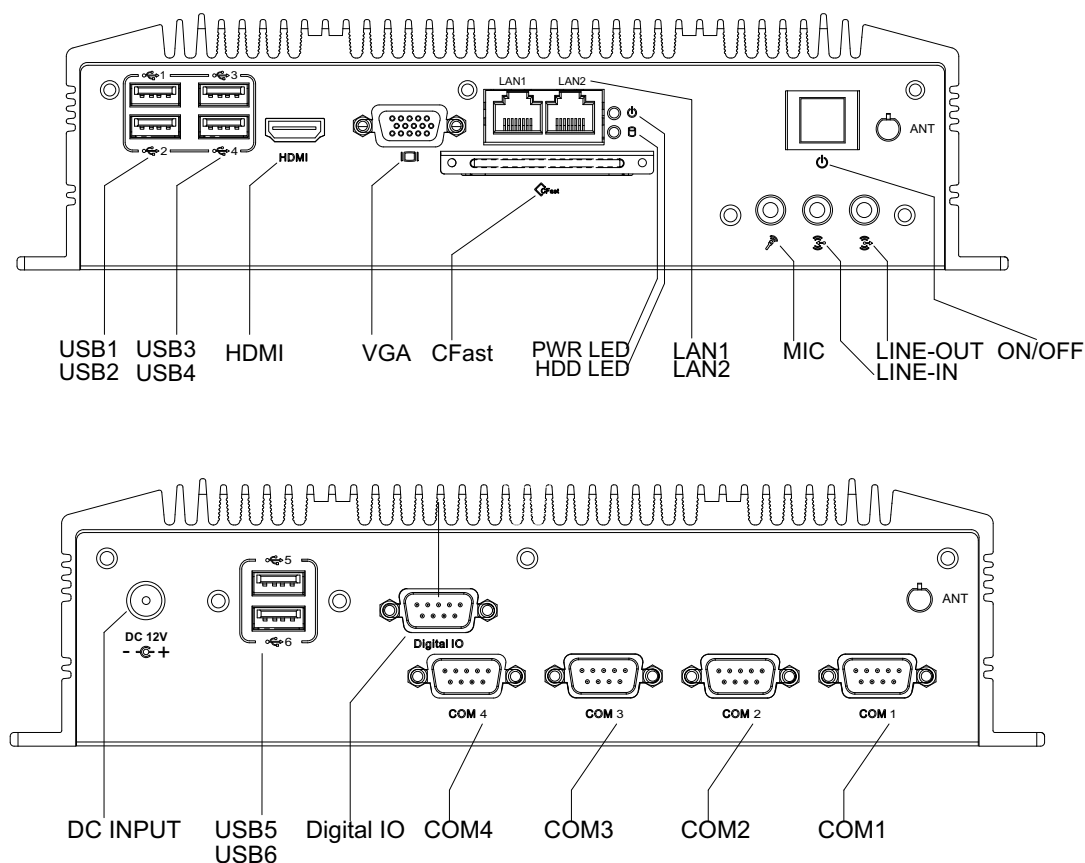

Figure 2.3 ARK-2120L IO connectors drawing

ARK-2120F

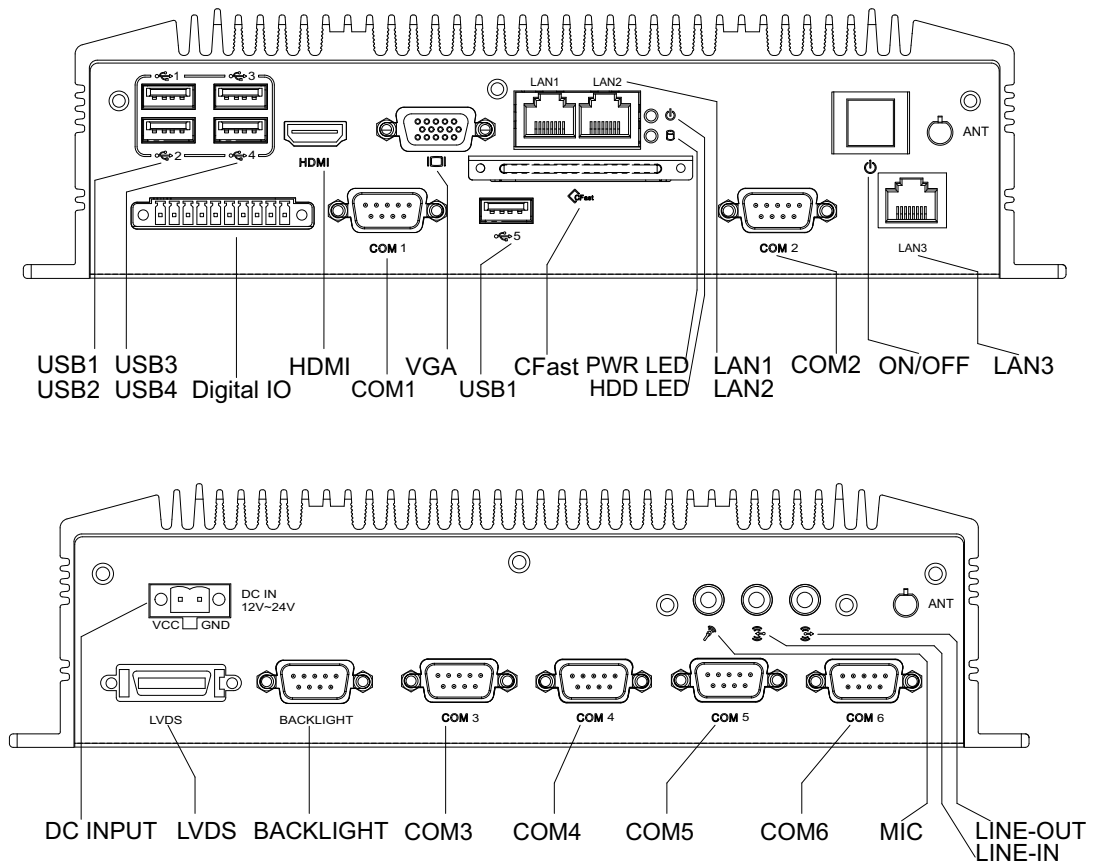

Figure 2.4 ARK-2120F IO connectors drawing

2.3.1.1 COM Connector

ARK-2120 provides up to six D-sub 9-pin connectors, which offers RS-232/422/485 serial communication interface ports. Default setting is RS-232, if you want to use RS-422/485, you can find the jumper installation in Chapter 2.2.4 for ARK-2120L and BIOS setting in Chapter 3.4.9.

The RS-422/485 mode of ARK-2120F COM3~COM6 can be supported via BIOS setting. The setting is under Advanced BIOS Features Setup -> Super IO Configuration.

The RS-422/485 mode of ARK-2120L COM2 can be supported via replacing the internal COM 2 cable by using the new cable (Part Number 1700001967), and adjusting the jumper J2 inside the system. The extra cable has been stored in the accessory box of the product carton.

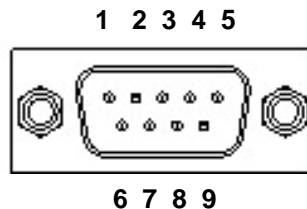

Figure 2.5 COM connector

Table 2.2: COM Connector Pin Assignments

	RS-232	RS-422	RS-485
Pin	Signal Name	Signal Name	Signal Name
1	DCD	Tx-	DATA-
2	RxD	Tx+	DATA+
3	TxD	Rx+	NC
4	DTR	Rx-	NC
5	GND	GND	GND
6	DSR	NC	NC
7	RTS	NC	NC
8	CTS	NC	NC
9	RI	NC	NC

Note! NC represents "No Connection".



2.3.1.2 Ethernet Connector (LAN)

ARK-2120 is equipped up to three Ethernet controllers that are fully compliant with IEEE 802.3u 10/100/1000 Mbps CSMA/CD standards. LAN1, LAN2 and LAN3 are all equipped with Intel 82583V Ethernet controller. The Ethernet port provides a standard RJ-45 jack connector with LED indicators on the front side to show its Active/Link status (Green LED) and Speed status (Yellow LED).

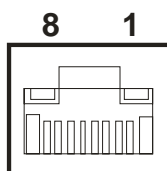

Figure 2.6 Ethernet connector

Table 2.3: Ethernet Connector Pin Assignments

Pin	10/100/1000BaseT Signal Name
1	TX+
2	TX-
3	RX+
4	MDI2+
5	MDI2-
6	RX-
7	MDI3+
8	MDI3-

2.3.1.3 Audio Connector

ARK-2120 offers stereo audio ports by three phone jack connectors of Line_Out, Line_In, Mic_In. The audio chip is controlled by ALC892, and it's compliant with Azalea standard.

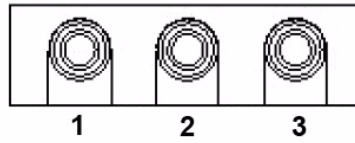

Figure 2.7 Audio connector

Table 2.4: Audio Connector Pin Assignments

Pin	Audio Signal Name
1	Mic_In
2	Line_Out
3	Line_In

2.3.1.4 DIO Connector

ARK-2120F provides one phoenix 10-pin male connectors and ARK-2120L provides one DSUB 9-pin female connectors, which offer Digital Input/Output communication interface. If client wants to use DIO, please find the pin assignment as following.

ARK-2120L

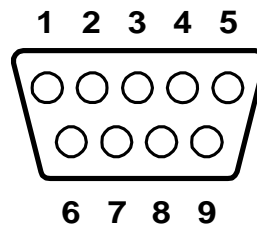

Figure 2.8 DIO Connector (ARK-2120L)

Table 2.5: DIO Connector Pin Assignments (ARK-2120L)

Pin	Signal Name
1	DIO bit0
2	DIO bit1
3	DIO bit2
4	DIO bit3
5	DIO bit4
6	DIO bit5
7	DIO bit6
8	DIO bit7
9	GND

ARK-2120F



Figure 2.9 DIO connector (ARK-2120F)

Table 2.6: DIO Connector Pin Assignments (ARK-2120F)

Pin	Signal Name
1	+V5
2	DIO0
3	DIO1
4	DIO2
5	DIO3
6	DIO4
7	DIO5
8	DIO6
9	DIO7
10	GND

2.3.1.5 USB Connector

ARK-2120 provides up to six USB interface connectors, which give complete Plug & Play and hot swapping for up to 127 external devices. The USB interface complies with USB UHCI, Rev. 2.0 compliant. The USB interface can be disabled in the system BIOS setup. Please refer to Table. 2.7 for its pin assignments. The USB connectors are used to connect any device that conforms to the USB interface. Most digital devices conform to this standard. The USB interface supports Plug and Play without turning off computers.

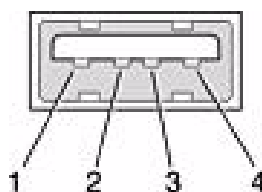

Figure 2.10 USB connector

Table 2.7: USB Connector

Pin	Signal name	Pin	Signal name
1	VCC	2	USB_data-
3	USB_data+	4	GND

2.3.1.6 VGA Connector

The ARK-2120 provides a high resolution VGA interface connected by a D-sub 15-pin connector to support a VGA CRT monitor. It supports display resolution up to 1900 x 1200.

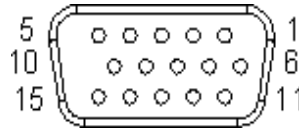

Figure 2.11 VGA Connector

Table 2.8: VGA Connector Pin Assignments

Pin	Signal Name	Pin	Signal Name
1	Red	2	Green
3	Blue	4	NC
5	GND	6	GND
7	GND	8	GND
9	NC	10	GND
11	NC	12	NC
13	H-SYNC	14	V-SYNC
15	NC		

2.3.1.7 Power Input Connector

ARK-2120L comes with a lockable DC Jack that carries 12 VDC external power input and ARK-2120F comes with a two pins header that carries 12 ~ 24 VDC external power input.

ARK-2120L



Figure 2.12 Power Input Connector (ARK-2120L)

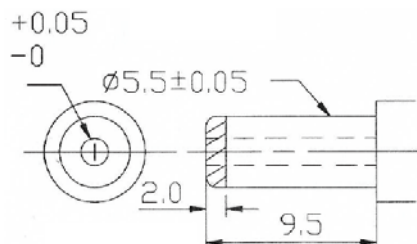

Figure 2.13 Compatible dimension of DC Plug for ARK-2120L

ARK-2120F

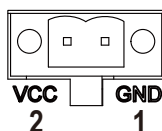

Figure 2.14 Power Input Connector (ARK-2120F)

Table 2.9: Power connector Pin Assignments (ARK-2120F)

Pin	Signal Name
1	GND
2	+12~24 VDC

2.3.1.8 Power ON/OFF Button

ARK-2120 comes with a Power On/Off button, that support dual function of Soft Power -On/Off (Instant off or Delay 4 Second), and Suspend.

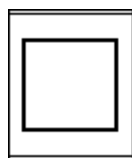

Figure 2.15 Power Button

2.3.1.9 LED Indicators

There are two LEDs on ARK-2120 front metal face plate for indicating system status: PWR LED is for power status; and HDD LED is for HDD & Cfast flash disk status.



Figure 2.16 LED Indicators

2.3.1.10 LVDS Connector (ARK-2120F only)

The ARK-2120 comes with a D-Sub 26-pin connector that carries LVDS signal output, and can direct connect to LVDS LCD Display via external cable.

The system also provide a jumper of J2 on internal motherboard for selecting the LCD signal power of 3.3V, 5V or 12V, please refer to the jumper table of J2 to adjust it. The default setting of J2 is 3.3V.

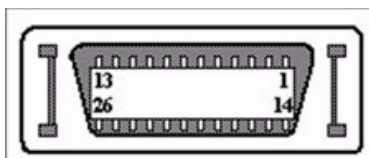

Figure 2.17 LVDS Connector

Table 2.10: LVDS Connector Pin Assignment

Pin	Signal Name	Pin	Signal name
1	LVDS_CLKBP	14	LVDS_CLKBM
2	GND	15	LVDS_YAM0
3	LVDS_YAP0	16	LVDS_YAM1
4	LVDS_YAP1	17	LVDS_YAM2
5	LVDS_YAP2	18	LVDS_CLKAM
6	LVDS_CLKAP	19	GND
7	3.3V, 5V or 12V	20	3.3V, 5V or 12V
8	GND	21	LVDS_YAM3
9	LVDS_YAP3	22	LVDS_YBM0
10	LVDS_YBP0	23	LVDS_YBM1
11	LVDS_YBP1	24	LVDS_YBM2
12	LVDS_YBP2	25	LVDS_YBM3
13	LVDS_YBP3	26	GND

2.3.1.11 LCD Backlight On/Off control Connector (ARK-2120F only)

The ARK-2120 comes with a D-Sub 9-pin connector which provides BKLTEN signal as well as +12 V, +5 V and Ground Pin signals that allow the user to connect these signals to LCD Inverter to implement the LCD On/Off control.

- Provides BKLTEN signal that inverter Module requires for inverter on/off control
- Provides 12 V, 5 V as the Inverter Power Source. The additional VBR signal pin could be connected to LCD's Inverter that allows the user to achieve brightness adjustment through customer's software utility.

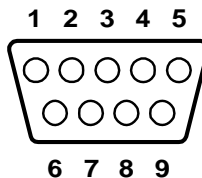
**Figure 2.18 LCD Backlight connector****Table 2.11: LCD Backlight Connector Pin Assignment**

Pin	Signal name
1	+12 V
2	GND
3	BKLTEN
4	VBR
5	+5 V
6	LVDS_DCLK
7	LVDS_DDAT
8	Reserved
9	Reserved

2.4 Installation

2.4.1 HDD Installation

1. Unscrew the six screws on the bottom cover.

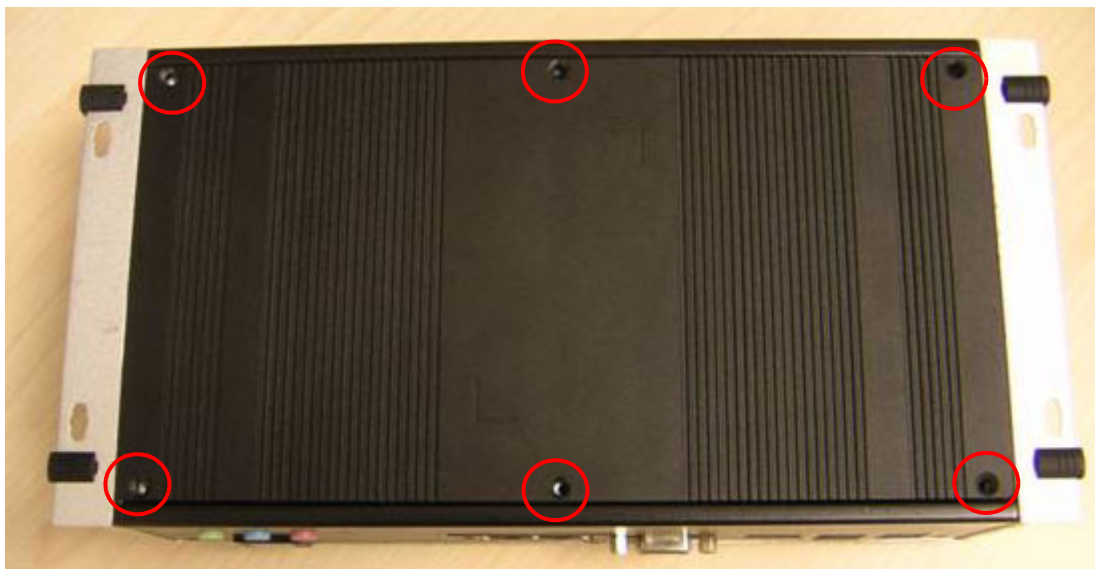

2. Slide the 2.5" SATA HDD into the HDD bay on the bottom cover.



3. Screw the four screws on the side of HDD bracket. The screws are used to fix the HDD on the bracket. (The screws are in the accessory box.)

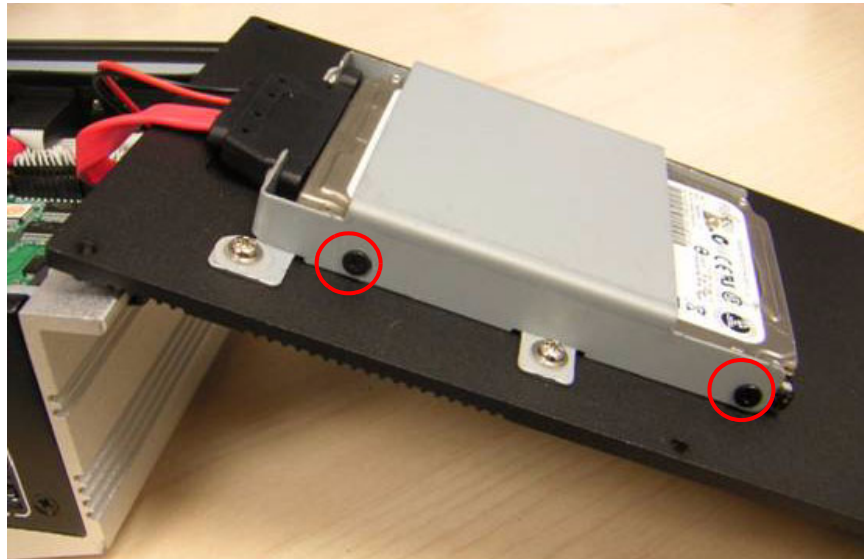

4. Recover the bottom cover and screws.

2.4.2 Memory Installation

1. Unscrew the four screws on the top cover.

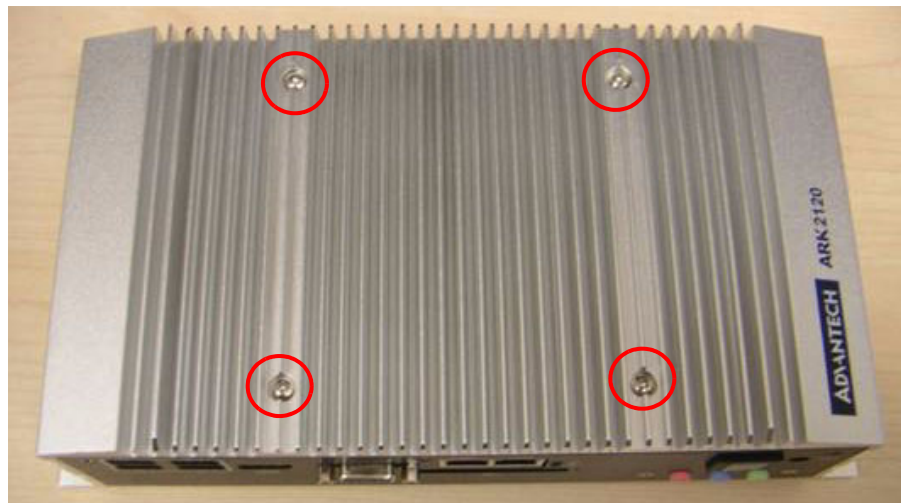

2. Unscrew the four screws on the right and left side of top cover



3. Remove the top cover

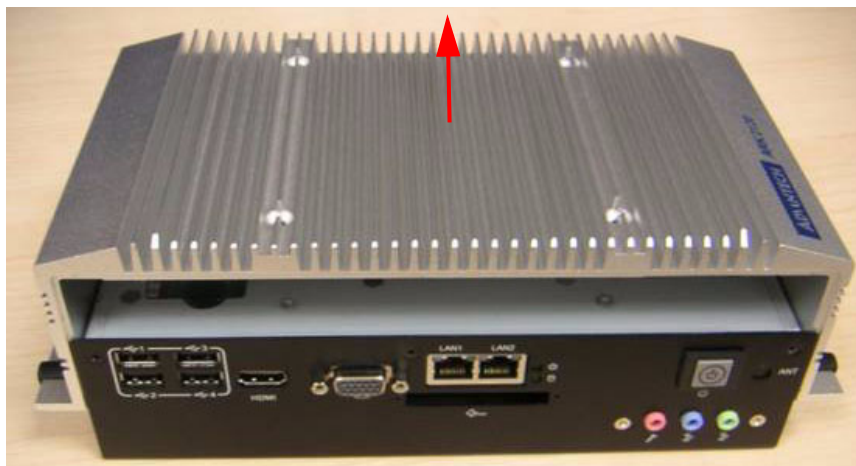

4. Install DDR3 memory in to the system



5. Recover the top chassis.

2.4.3 CFast Installation

1. Unscrew the two screws on the CFast door.



2. Pull the CFast tray out.

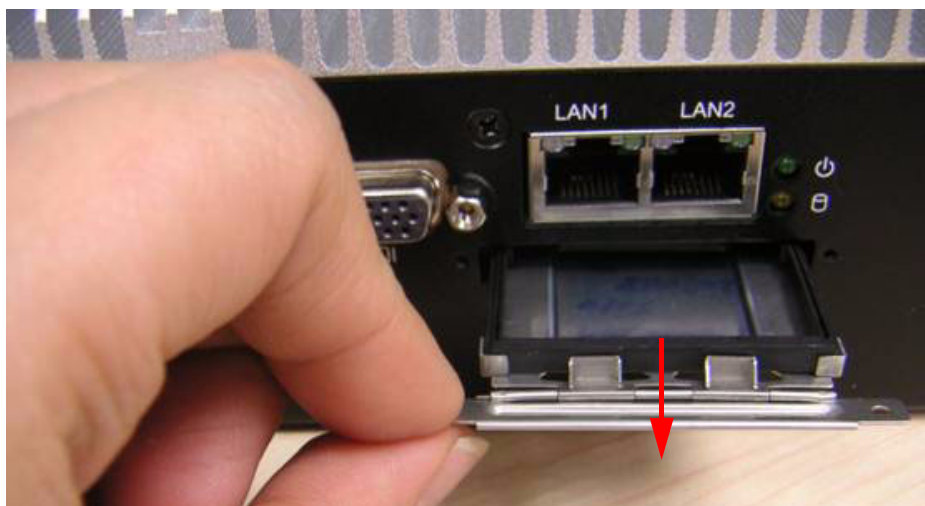

3. Remove the dummy CFast bracket.

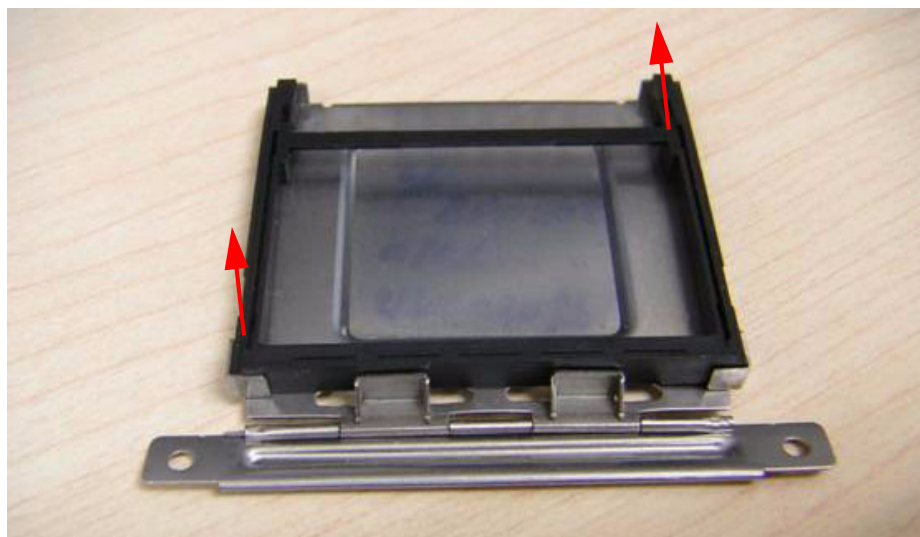

4. Put CFast on to the CFast tray.



5. Push the CF tray back and secure with screws.

Chapter 3

BIOS Settings

3.1 BIOS Setup

AMIBIOS has been integrated into many motherboards for over a decade. With the AMIBIOS setup program, you can modify BIOS settings and control the various system features. This chapter describes the basic navigation of the ARK-2120 BIOS setup screens.



Figure 3.1 Setup program initial screen

AMI's BIOS ROM has a built-in Setup program that allows users to modify the basic system configuration. This information is stored in flash ROM so it retains the Setup information when the power is turned off.

3.2 Entering Setup

Turn on the computer and then press <F2> or to enter Setup menu.

3.3 Main Setup

When users first enter the BIOS Setup Utility, users will enter the Main setup screen. Users can always return to the Main setup screen by selecting the Main tab. There are two Main Setup options. They are described in this section. The Main BIOS Setup screen is shown below.



Figure 3.2 Main setup screen

The Main BIOS setup screen has two main frames. The left frame displays all the options that can be configured. Grayed-out options cannot be configured; options in blue can. The right frame displays the key legend.

Above the key legend is an area reserved for a text message. When an option is selected in the left frame, it is highlighted in white. Often a text message will accompany it.

3.3.1 System date / System time

Use this option to change the system time and date. Highlight System Time or System Date using the <Arrow> keys. Enter new values through the keyboard. Press the <Tab> key or the <Arrow> keys to move between fields. The date must be entered in MM/DD/YY format. The time must be entered in HH:MM:SS format.

3.4 Advanced BIOS Features Setup

Select the Advanced tab from the ARK-2120 setup screen to enter the Advanced BIOS Setup screen. You can select any of the items in the left frame of the screen, such as CPU Configuration, to go to the sub menu for that item. You can display an Advanced BIOS Setup option by highlighting it using the <Arrow> keys. All Advanced BIOS Setup options are described in this section. The Advanced BIOS Setup screens are shown below. The sub menus are described on the following pages.

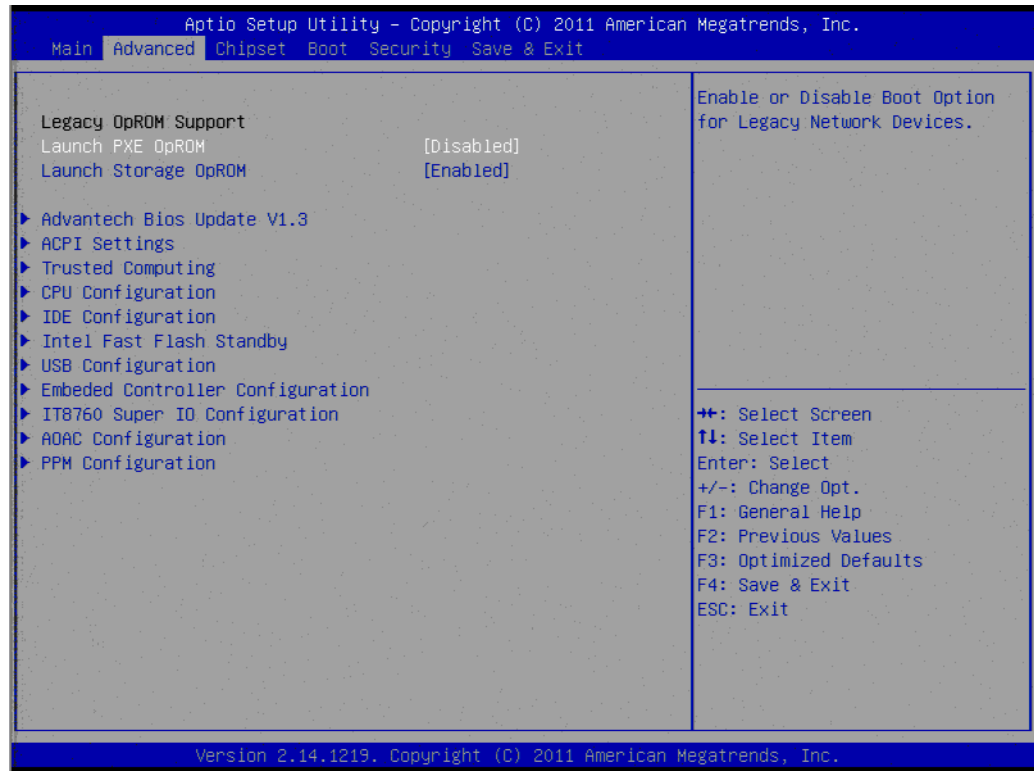

Figure 3.3 Advanced BIOS features setup screen

- **Launch PXE OpROM**
This item allows users to enable or disable launch PXE OpROM if available.
- **Launch Storage OpROM**
This item allows users to enable or disable launch storage OpROM if available.

3.4.1 Advantech BIOS Update V1.3

This item allows users to flash BIOS. Please save the new BIOS in a USB pen drive and rename its file name as "update.bin". Plug the pen drive on ARK-2120 and boot into the BIOS setting. Then select this item, the system will update the new BIOS automatically.

3.4.2 ACPI Settings

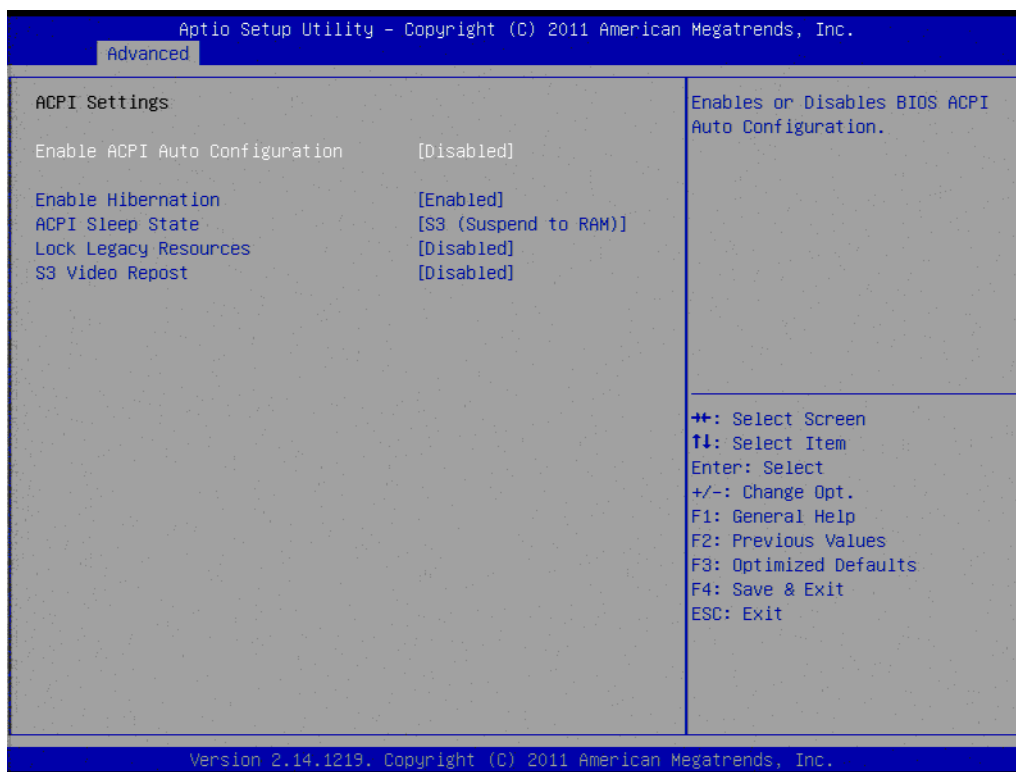

Figure 3.4 ACPI Setting

- **Enable ACPI Auto Configuration**
This item allows users to enable or disable BIOS ACPI auto configuration.
- **Enable Hibernation**
This item allows users to enable or disable hibernation.
- **ACPI Sleep State**
This item allows users to set the ACPI sleep state.
- **Lock Legacy Resources**
This item allows users to lock legacy devices' resources.
- **S3 Video Report**
This item allows users to enable or disable S3 resume for VBIOS.

3.4.3 TPM Configuration

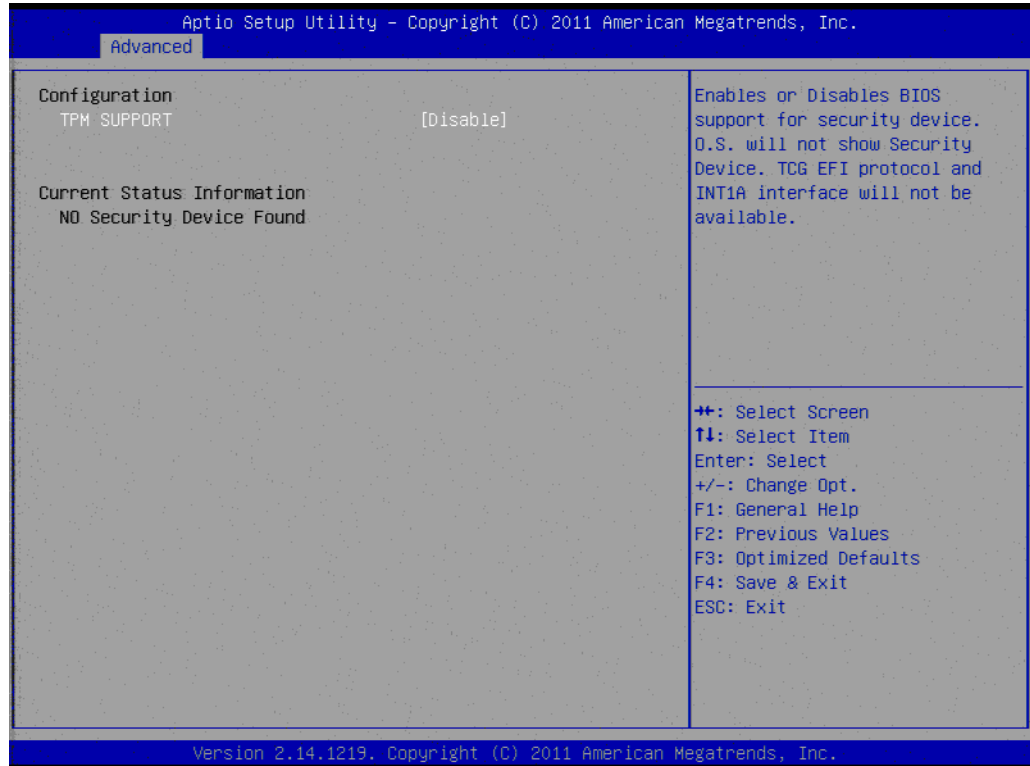

Figure 3.5 TPM Configuration

- **TPM Support**
Disable/Enable TPM if available.

3.4.4 CPU Configuration

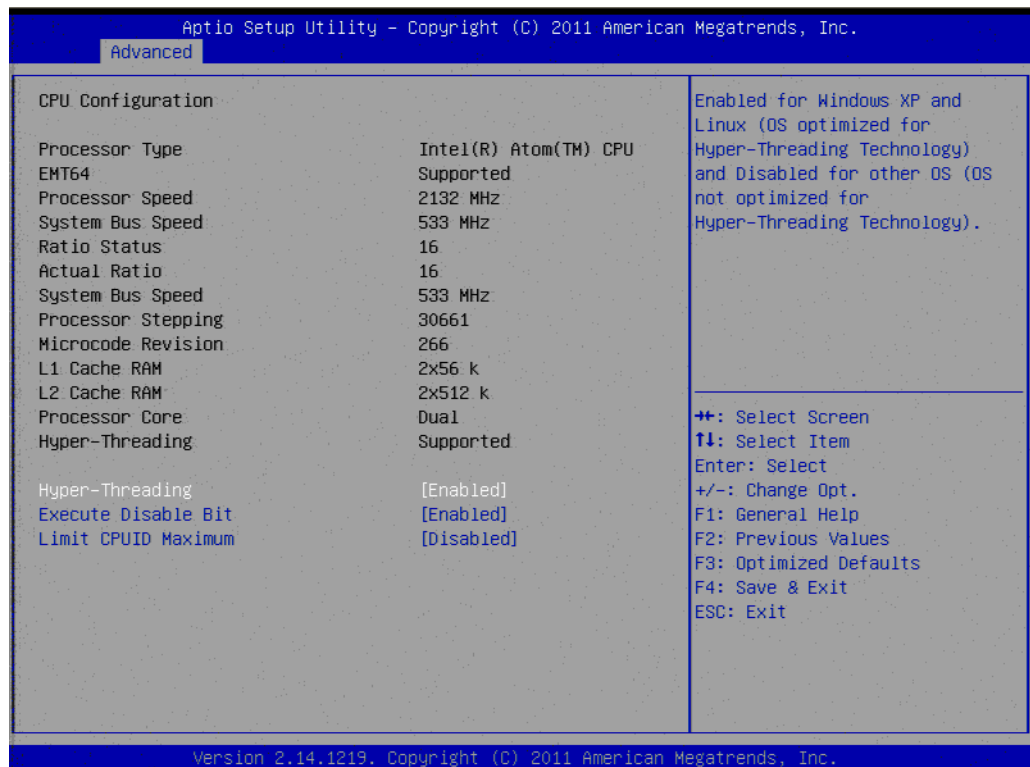

Figure 3.6 CPU Configuration

- **Hyper Threading Technology**
This item allows users to enable or disable Intel? Hyper Threading technology.
- **Execute Disable Bit**
This item allows users to enable or disable the No-Execution page protection
- **Limit CPUID Maximum**
This item allows users to enable or disable limit CPUID maximum for Windows XP.

3.4.5 SATA Configuration

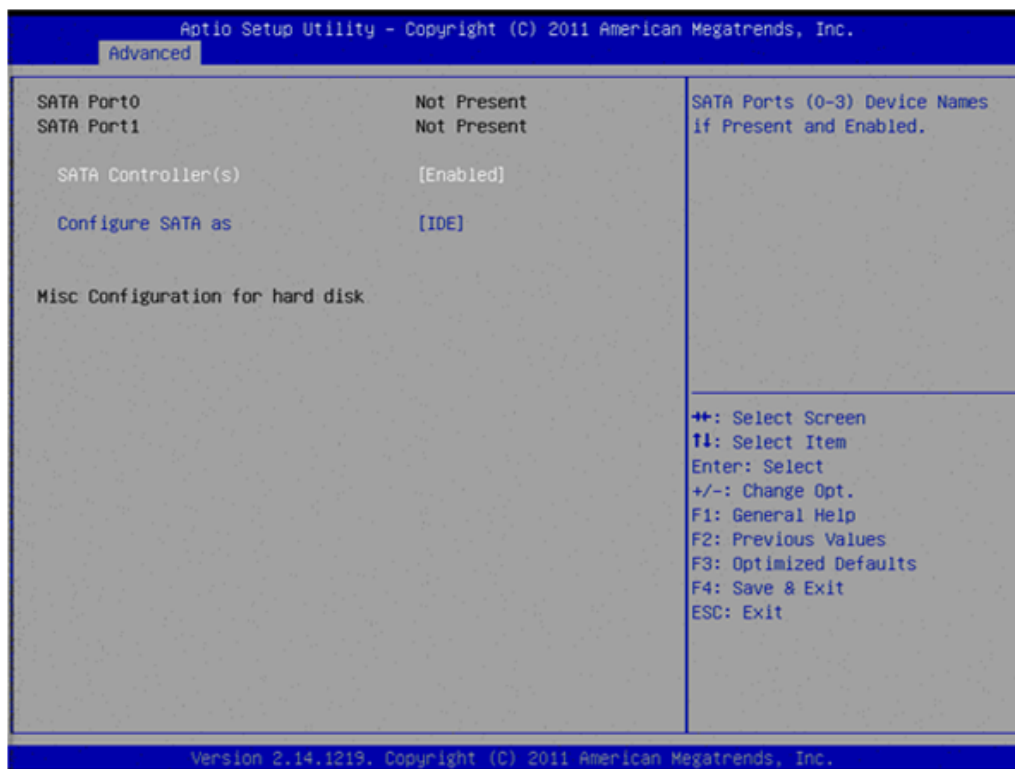

Figure 3.7 SATA Configuration

- **SATA Controller(s)**
This item allows users to enable or disable the SATA controller(s).
- **SATA Mode Selection**
This item allows users to select mode of SATA controller(s).

3.4.6 Intel Fast Flash Standby

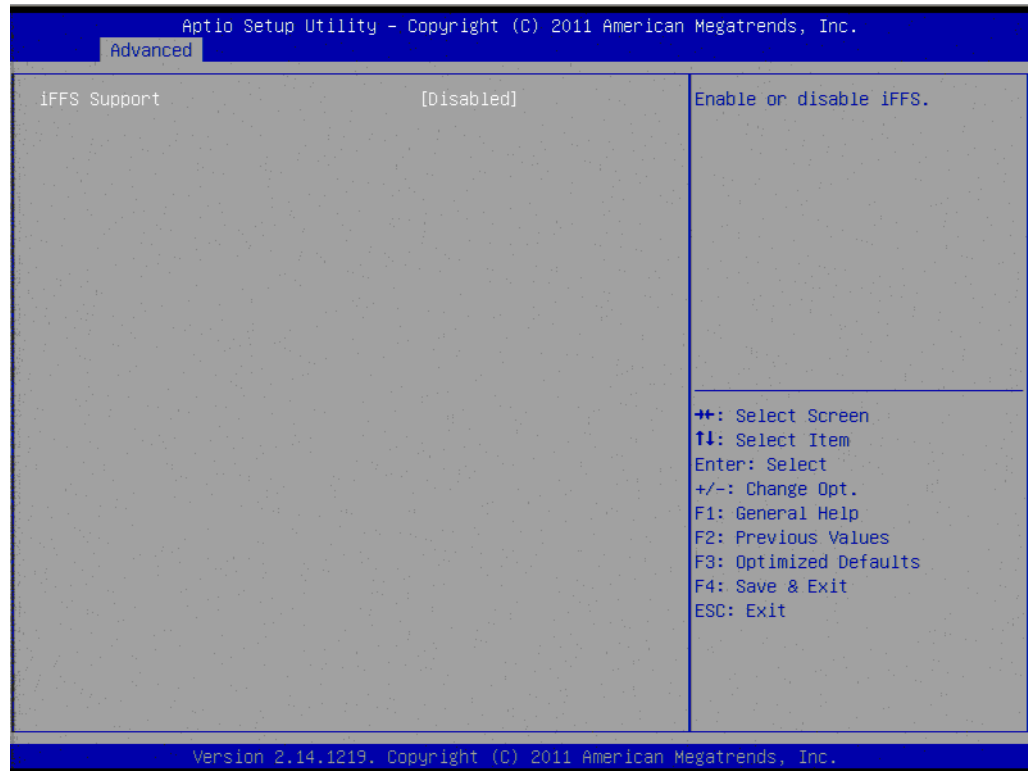

Figure 3.8 Intel Fast Flash Standby

- **IFFS Support**
This item allows users to enable or disable iFFS.

3.4.7 USB Configuration

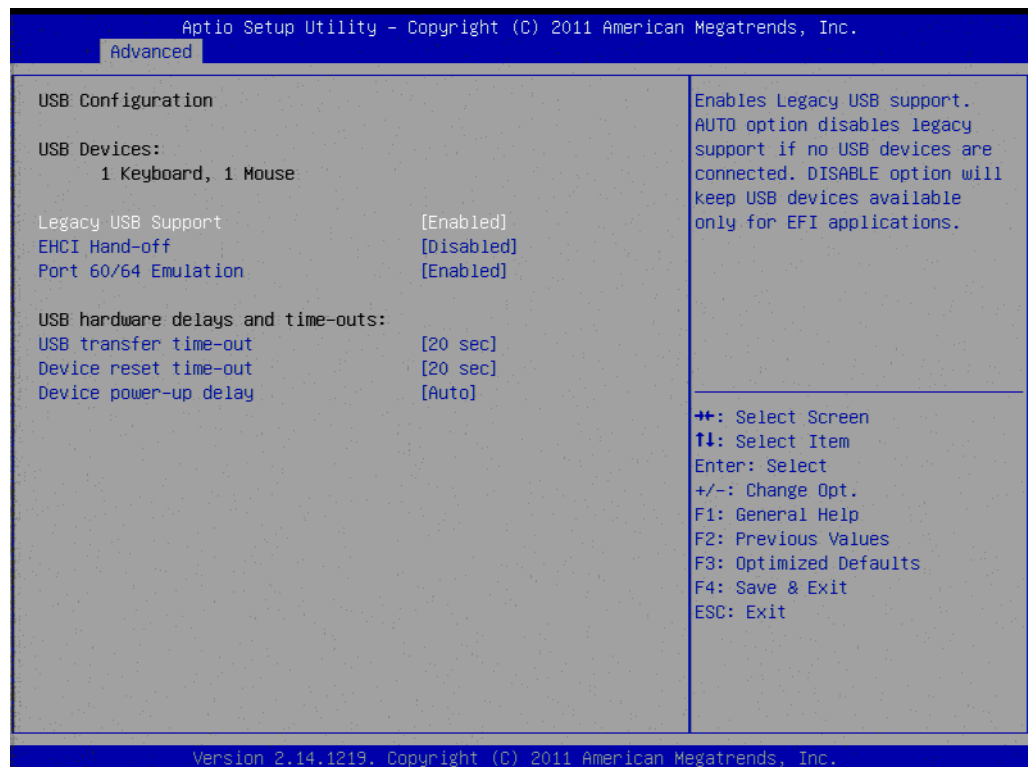

Figure 3.9 USB Configuration

- **Legacy USB Support**
Enable the support for legacy USB. Auto option disables legacy support if no USB devices are connected.
- **EHCI Hand-Off**
This is a workaround for the OS without EHCI hand-off support. The EHCI ownership change should claim by EHCI driver.
- **Port 60/64 Emulation**
Enable or disable I/O port 60h/64h emulation support.
- **USB transfer time-out**
Set the time-out value for Control, Bulk, and Interrupt transfers.
- **Device reset time-out**
Set USB mass storage device Start Unit command time-out value.
- **Device power-up delay**
Sets the maximum time the device will take before it properly reports itself to the Host Controller. 'Auto' uses a default value: for a Root port it is 100 ms, for a Hub port the delay is taken from the Hub descriptor.

3.4.8 Embedded Controller Configuration



Figure 3.10 Embedded Controller Configuration

- **EC iManager WatchDog IRQ**
This item allows users to set the irq number of EC watchdog.
- **EC Power Saving Mode**
This item allows users to set board's power saving mode when off.
- **EC iManager Smart FAN**
This item allows users to enable or disable smart FAN feature.
- **Backlight Enable Polarity (F version only)**
This item allows users to set backlight enable polarity.
- **EC Watch Dog Function**
This item allows users to enable or disabled EC watchdog function.

3.4.9 Super I/O Configuration



Figure 3.11 Super IO Configuration

- Serial Port 0 Configuration
This item allows users to configure serial port 0.
- Serial Port 1 Configuration
This item allows users to configure serial port 1.
- Serial Port 2 Configuration
This item allows users to configure serial port 2.
- Serial Port 3 Configuration
This item allows users to configure serial port 3.

3.4.10 AOAC Configuration

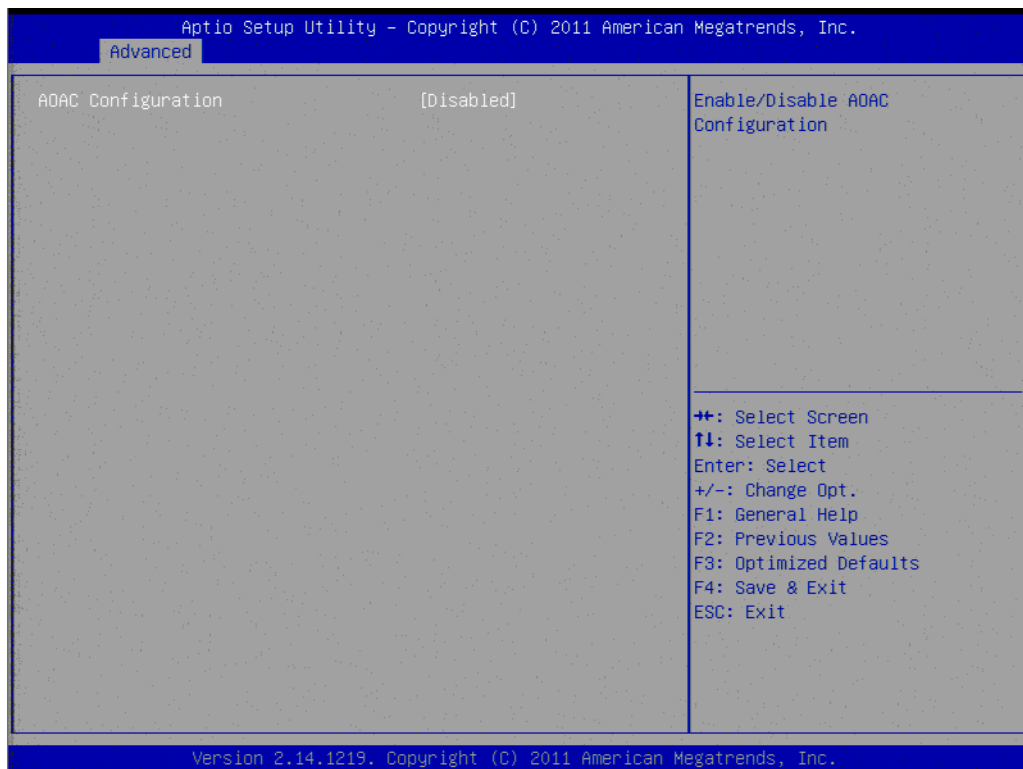

Figure 3.12 AOAC Configuration

- AOAC Configuration
This item allows users to enable or disabled AOAC function.

3.4.11 PPM Configuration

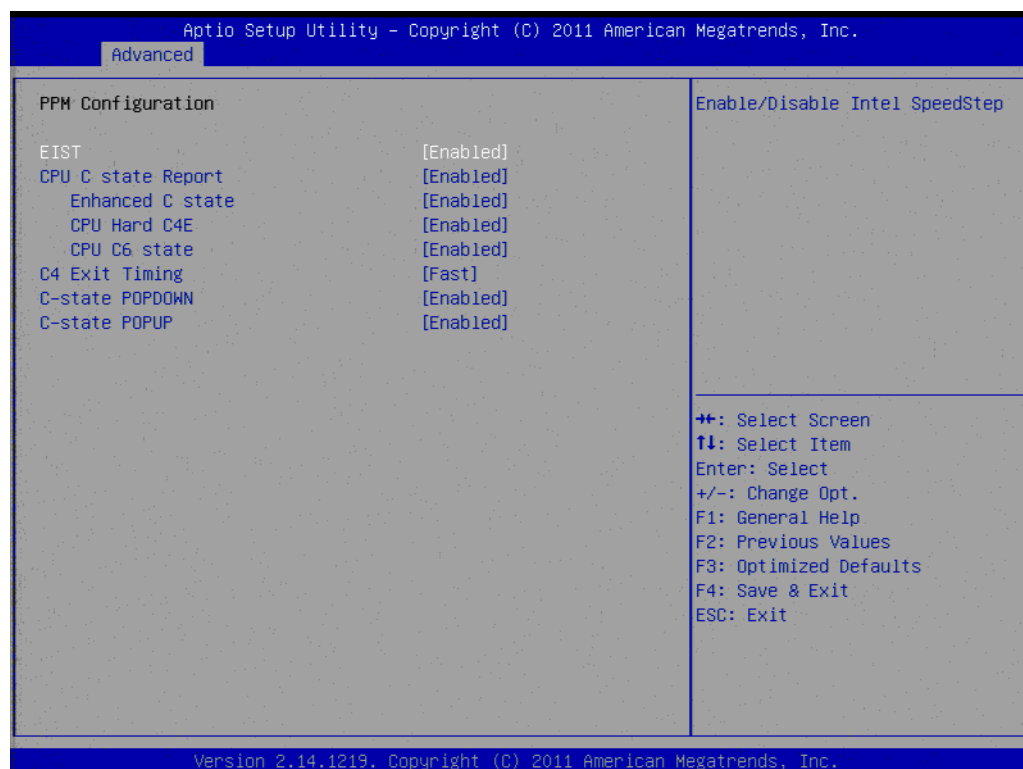

Figure 3.13 PPM Configuration

- **EIST**
This item allows users to enable or disabled Intel SpeedStep function.
- **CPU C state Report**
This item allows users to enable or disabled CPU C state report to OS.
- **Enhanced C state**
This item allows users to enable or disabled Enhanced CPU C state.
- **CPU Hard C4E**
This item allows users to enable or disabled CPU Hard C4E function.
- **CPU C6 state**
This item allows users to enable or disabled CPU C6 state.
- **C4 Exit Timing**
This item allows users to control a programmable time for the CPU voltage to stabilize when exiting from a C4 state.
- **C-state POPDOWN**
This item allows users to enable or disabled Intel C-state POPDOWN function.
- **C-state POPUP**
This item allows users to enable or disabled Intel C-state POPUP function.

3.5 Chipset Configuration

Select the Chipset tab from the ARK-2120 setup screen to enter the Chipset BIOS Setup screen. You can display a Chipset BIOS Setup option by highlighting it using the <Arrow> keys. All Plug and Play BIOS Setup options are described in this section.

The Plug and Play BIOS Setup screen is shown below.



Figure 3.14 Chipset Setup

3.5.1 Host Bridge/Intel IGD Configuration

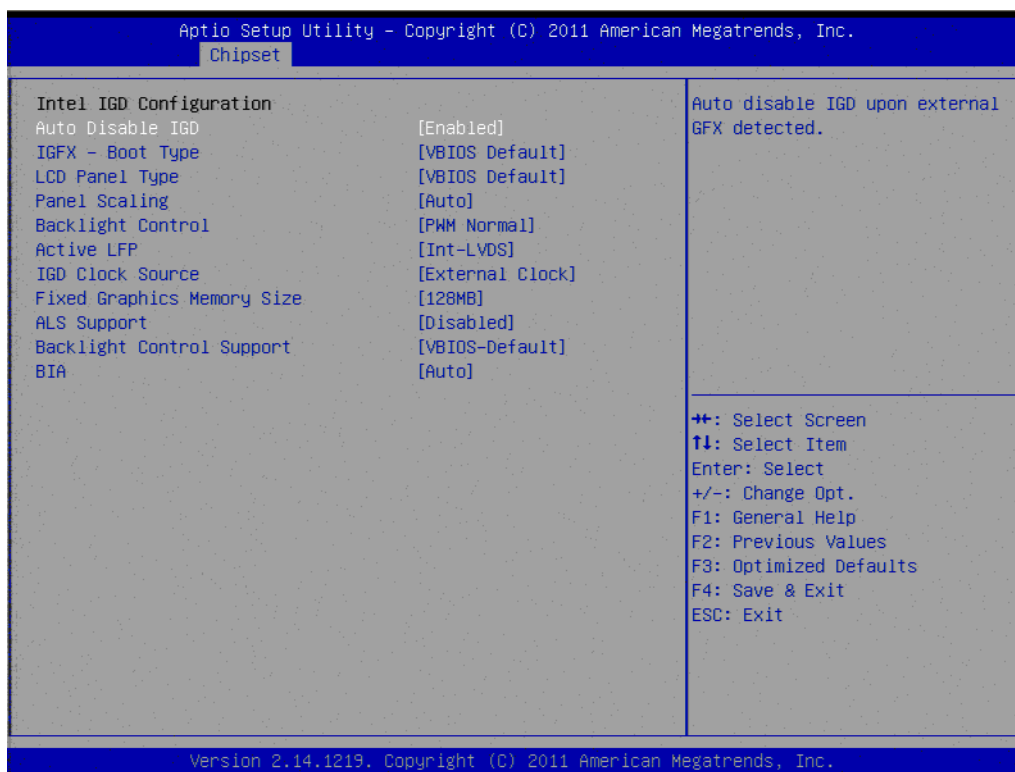

Figure 3.15 Intel IGD Configuration

- **Auto Disable IGD**
This item allows users to auto disable IGD upon external GFX detected.
- **IGFX - Boot Type**
This item allows users to select which output device during POST.
- **LCD Panel Type (F version only)**
This item allows users to select LCD panel by internal graphic device.
- **Panel Scaling (F version only)**
This item allows users to select LCD panel scaling by internal graphic device.
- **Backlight Control (F version only)**
This item allows users to select backlight control setting.
- **Active LFP (F version only)**
This item allows users to select the active LFP configuration.
- **IGD Clock Source (F version only)**
This item allows users to select IGD clock.
- **Fixed Graphics Memory Size**
This item allows users to configure fixed graphic memory size.
- **ALS Support (F version only)**
This item allows users to select ASL support for ACPI.
- **Backlight Control Support (F version only)**
This item allows users to select backlight control support.
- **BIA (F version only)**
This item allows users to select BIA with selected aggressiveness level.

3.5.2 South Bridge

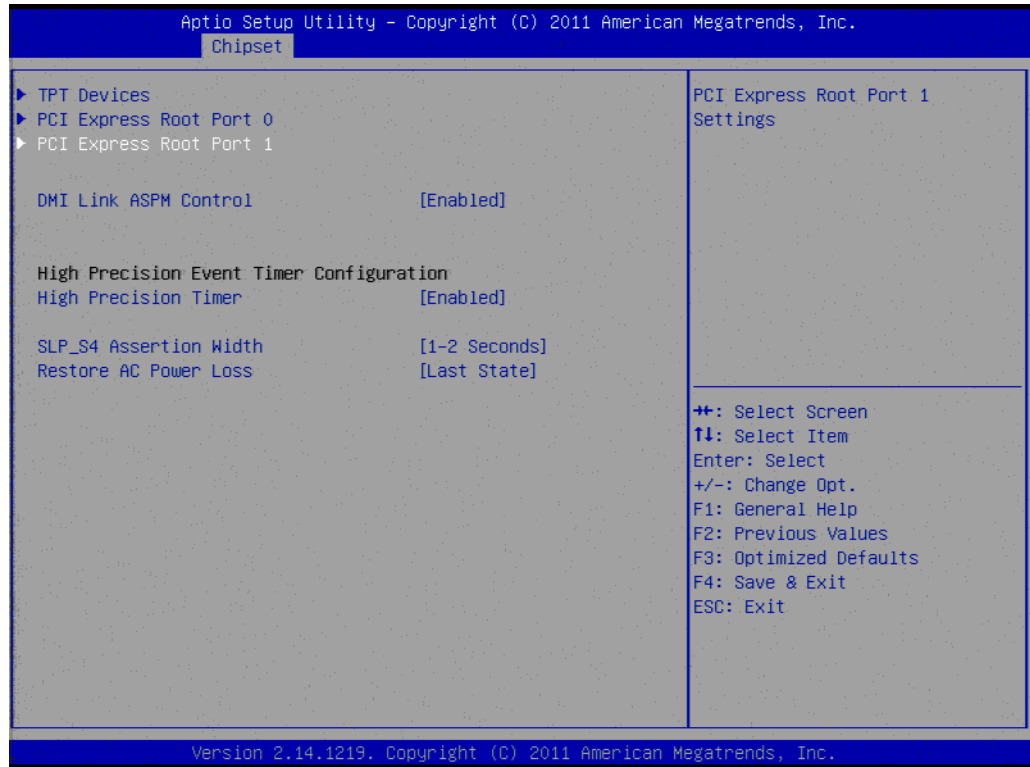

Figure 3.16 South Bridge

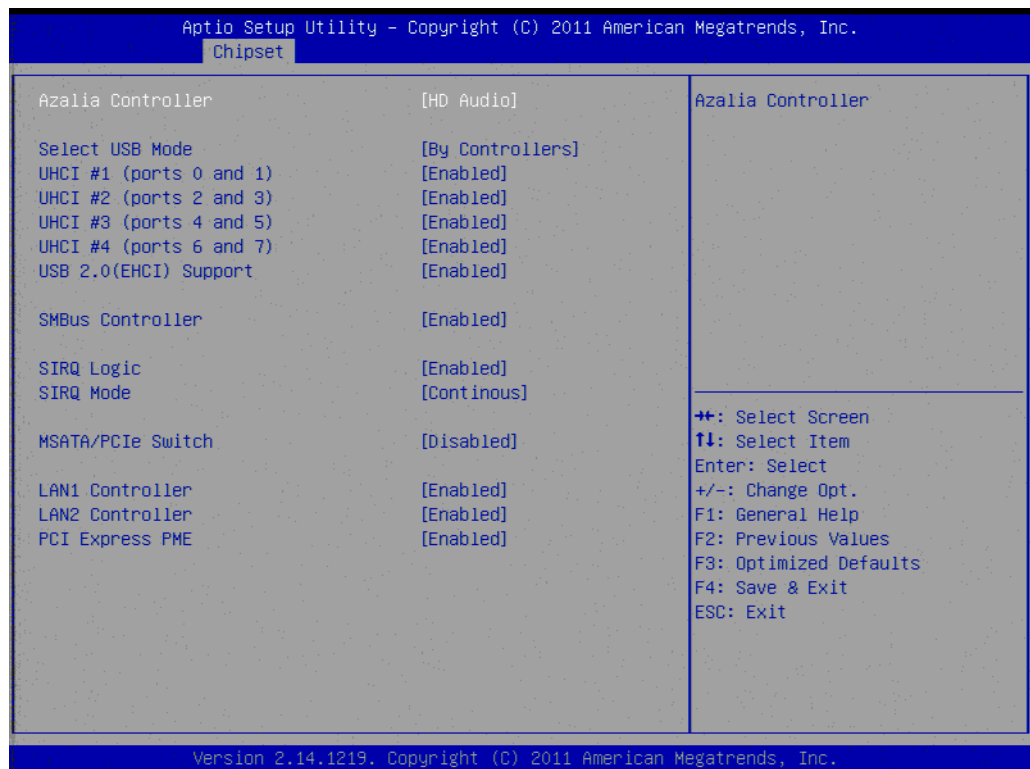

Figure 3.17 TPT Device

- **Azalia Controller**
Enables or disables the azalia controller.

- **Select USB Mode**
Select USB mode by controllers or ports.
- **SMBus Controller**
Enables or disables the onchip SMBus controller.
- **SIRQ Logic**
Enables or disables the SIRQ logic.
- **SIRQ Mode**
Set SIRQ mode.
- **MSATA/PCIe Switch**
Enables for MSATA disables for PCIe.
- **LAN1/LAN2 Controller**
This item allows users to enables or disables LAN device.
- **PCI Express PME**
This item allows users to enables or disables PCIe PME function.
- **PCI Express Root Port 0/1**
This item allows users to config PCIe port 0/1 settings.
- **DMI Link ASPM Control**
This item Enables or disables control of active state power management on both NB and SB side of DMI link.
- **High Precision Timer**
Enables or disables the high precision timer.
- **SLP_S4 Assertion Width**
This item allows users to set a delay of sorts.
- **Restore AC Power Loss**

3.6 Boot Settings

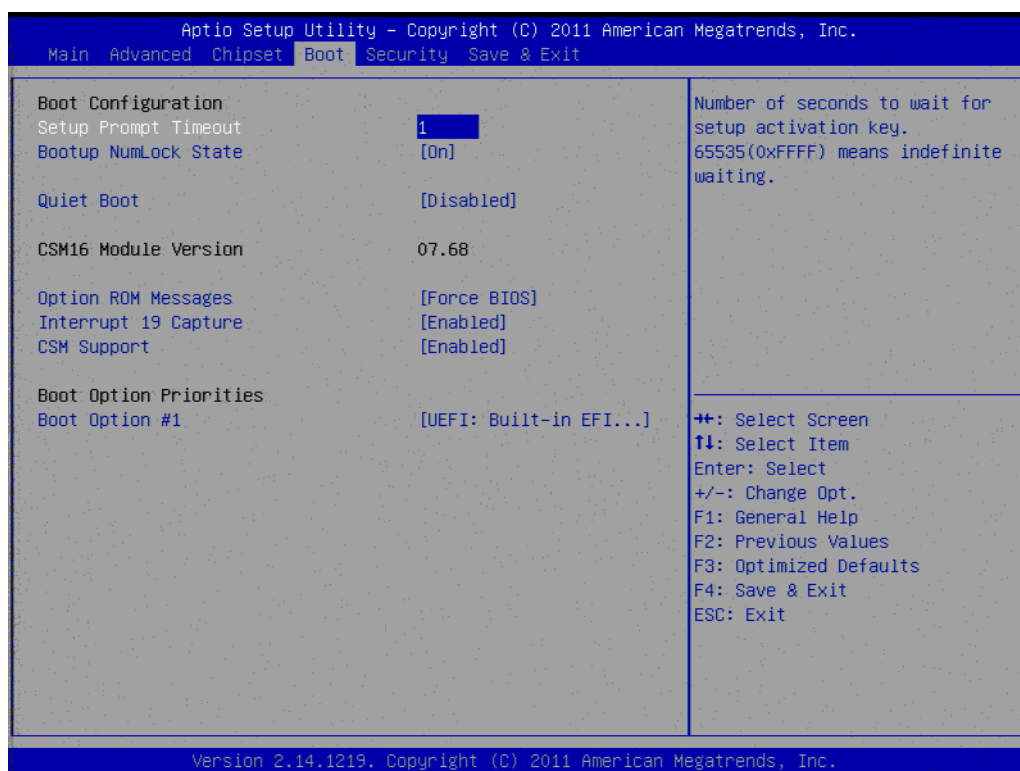

Figure 3.18 Boot Setup Utility

- **Setup Prompt Timeout**
This item allows users to select the number of seconds to wait for setup activation key.
- **Bootup NumLock State**
Select the Power-on state for Numlock.
- **Quiet Boot**
If this option is set to Disabled, the BIOS displays normal POST messages. If Enabled, an OEM Logo is shown instead of POST messages.
- **Option ROM Message**
Set display mode for option ROM.
- **Interrupt 19 Capture**
This item allows option ROMs to trap interrupt 19.
- **1st/2nd/3rd/4th/5th/6th/7th Boot**
This item allows users to set boot device priority.

3.7 Security Setup

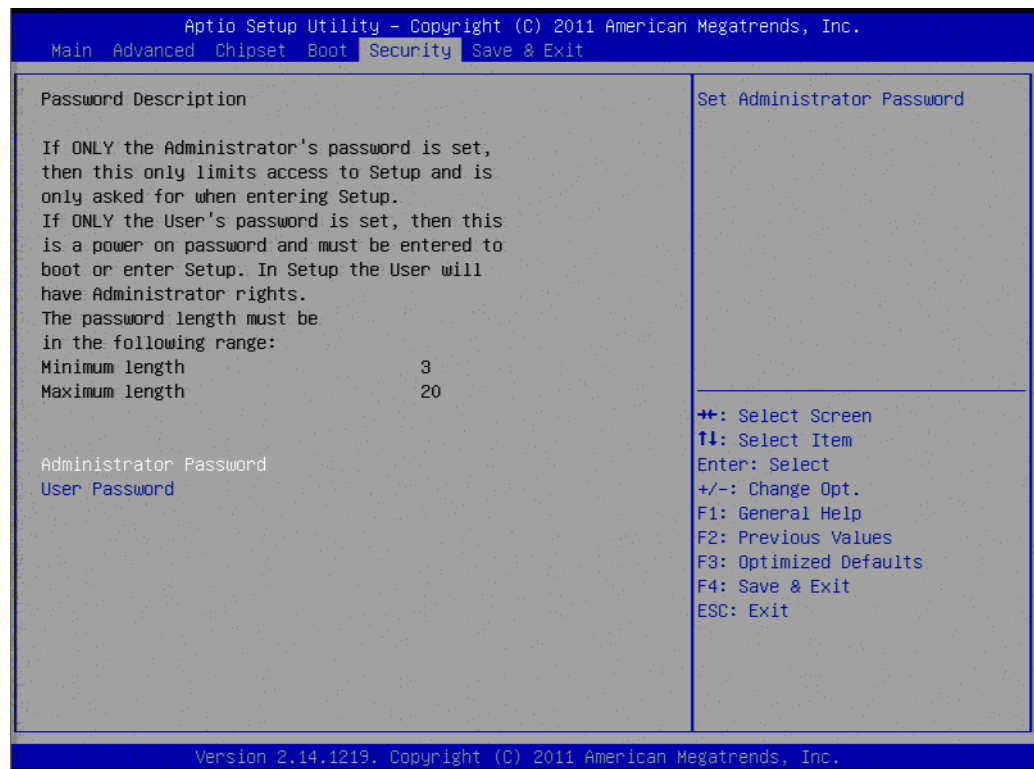

Figure 3.19 Password Configuration

Select Security Setup from the ARK-2120 Setup main BIOS setup menu. All Security Setup options, such as password protection is described in this section. To access the sub menu for the following items, select the item and press <Enter>:

- **Change Administrator / User Password**
Select this option and press <ENTER> to access the sub menu, and then type in the password.

3.8 Save & Exit

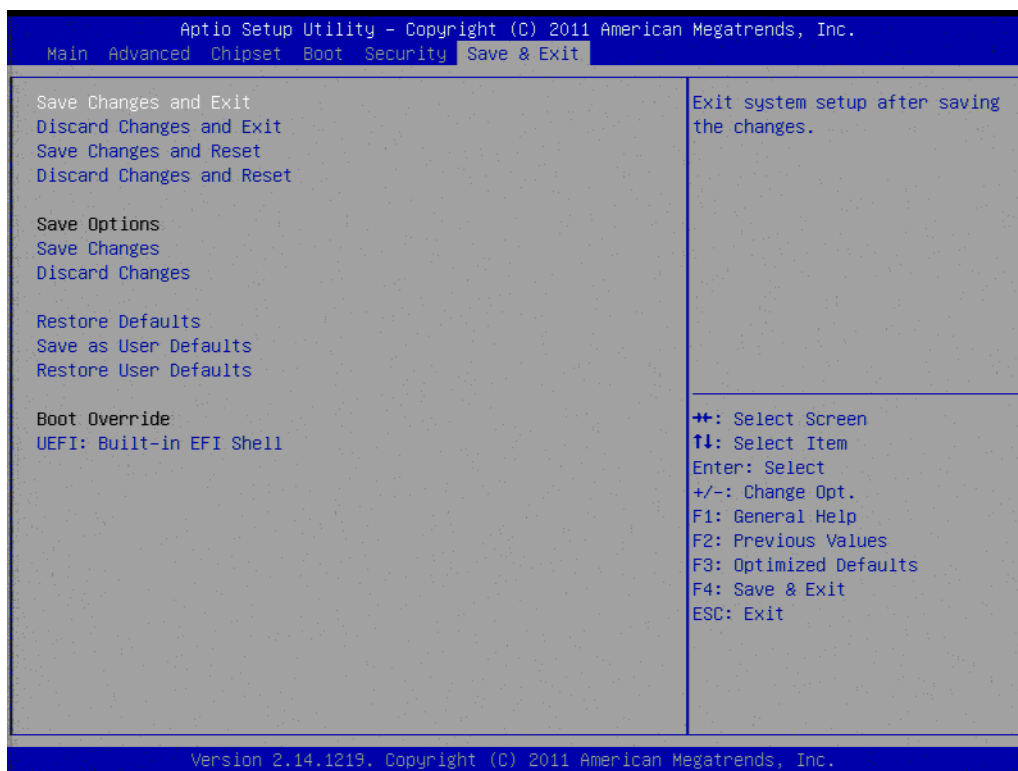

Figure 3.20 Save & Exit

3.8.1 Save Changes and Exit

When users have completed system configuration, select this option to save changes, exit BIOS setup menu and reboot the computer if necessary to take effect of all system configuration parameters.

3.8.2 Discard Changes and Exit

Select this option to quit Setup without making any permanent changes to the system configuration.

3.8.3 Save Changes and Reset

When users have completed system configuration, select this option to save changes, exit the BIOS setup menu and reboot the computer to take effect of all system configuration parameters.

3.8.4 Discard Changes and Reset

Select this option to quit Setup without making any permanent changes to the system configuration and reboot the computer.

3.8.5 Save Changes

When users have completed system configuration, select this option to save changes without exiting the BIOS setup menu.

3.8.6 Discard Changes

Select this option to discard any current changes and load previous system configuration.

3.8.7 Restore Defaults

The ARK-2120 automatically configures all setup items to optimal settings when users select this option. Optimal Defaults are designed for maximum system performance, but may not work best for all computer applications. In particular, do not use the Optimal Defaults if the user's computer is experiencing system configuration problems.

3.8.8 Save User Defaults

When users have completed system configuration, select this option to save changes as user defaults without exit BIOS setup menu.

3.8.9 Restore User Defaults

The users can select this option to restore user defaults.

3.8.10 Boot Override

You select device you want to do boot override.

Appendix **A**

Watchdog Timer
Sample Code

A.1 EC Watchdog Timer sample code

```
EC_Command_Port = 0x29Ah
EC_Data_Port = 0x299h
Write EC HW ram = 0x89
Watch dog event flag = 0x57
Watchdog reset delay time = 0x5E
Reset event = 0x04
Start WDT function = 0x28
=====
.model small
.486p
.stack 256
.data
.code
org 100h
.STARTUp

mov dx, EC_Command_Port
mov al,89h      ; Write EC HW ram.
out dx,al

mov dx, EC_Command_Port
mov al, 5Fh     ; Watchdog reset delay time low byte (5Eh is high byte) index.
out dx,al

mov dx, EC_Data_Port
mov al, 30h     ;Set 3 seconds delay time.
out dx,al

mov dx, EC_Command_Port
mov al,89h     ; Write EC HW ram.
out dx,al

mov dx, EC_Command_Port
mov al, 57h    ; Watch dog event flag.
out dx,al

mov dx, EC_Data_Port
mov al, 04h   ; Reset event.
out dx,al

mov dx, EC_Command_Port
mov al,28h   ; start WDT function.
out dx,al

.exit
END
```

ADVANTECH

Enabling an Intelligent Planet

www.advantech.com

Please verify specifications before quoting. This guide is intended for reference purposes only.

All product specifications are subject to change without notice.

No part of this publication may be reproduced in any form or by any means, electronic, photocopying, recording or otherwise, without prior written permission of the publisher.

All brand and product names are trademarks or registered trademarks of their respective companies.

© Advantech Co., Ltd. 2012