

# EPC2818 – Enhancement Mode Power Transistor

 $V_{DSS}, 150\text{ V}$ 
 $R_{DS(ON)}, 25\text{ m}\Omega$ 
 $I_D, 12\text{ A}$ 

High Lead Bump Finish: 95%Pb/5%Sn

NEW PRODUCT

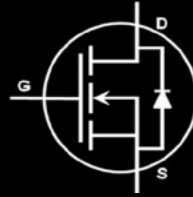

Gallium Nitride is grown on Silicon Wafers and processed using standard CMOS equipment leveraging the infrastructure that has been developed over the last 55 years. GaN's exceptionally high electron mobility and low temperature coefficient allows very low  $R_{DS(ON)}$ , while its lateral device structure and majority carrier diode provide exceptionally low  $Q_G$  and zero  $Q_{RR}$ . The end result is a device that can handle tasks where very high switching frequency, and low on-time are beneficial as well as those where on-state losses dominate.



EPC2818 eGaN® FETs are supplied only in passivated die form with solder bars

### Applications

- High Speed DC-DC conversion
- Class D Audio
- Hard Switched and High Frequency Circuits

### Benefits

- Ultra High Efficiency
- Ultra Low  $R_{DS(ON)}$
- Ultra low  $Q_G$
- Ultra small footprint

### Maximum Ratings

Parameter	Description	Value	Unit
$V_{DS}$	Drain-to-Source Voltage	150	V
$I_D$	Continuous ( $T_A = 25^\circ\text{C}$ , $\theta_{JA} = 17$ )	12	A
	Pulsed ( $25^\circ\text{C}$ , $T_{pulse} = 300\ \mu\text{s}$ )	60	
$V_{GS}$	Gate-to-Source Voltage	6	V
	Gate-to-Source Voltage	-5	
$T_J$	Operating Temperature	-40 to 125	$^\circ\text{C}$
$T_{STG}$	Storage Temperature	-40 to 150	

PARAMETER	TEST CONDITIONS	MIN	TYP	MAX	UNIT
<b>Static Characteristics (<math>T_J = 25^\circ\text{C}</math> unless otherwise stated)</b>					
$BV_{DSS}$	Drain-to-Source Voltage	$V_{GS} = 0\text{ V}, I_D = 200\ \mu\text{A}$	150		V
$I_{DSS}$	Drain Source Leakage	$V_{DS} = 120\text{ V}, V_{GS} = 0\text{ V}$		50	$\mu\text{A}$
$I_{GSS}$	Gate-Source Forward Leakage	$V_{GS} = 5\text{ V}$		1	mA
	Gate-Source Reverse Leakage	$V_{GS} = -5\text{ V}$		0.2	
$V_{GS(TH)}$	Gate Threshold Voltage	$V_{DS} = V_{GS}, I_D = 3\text{ mA}$	0.7	1.4	V
$R_{DS(ON)}$	Drain-Source On Resistance	$V_{GS} = 5\text{ V}, I_D = 6\text{ A}$		18	$\text{m}\Omega$
<b>Source-Drain Characteristics (<math>T_J = 25^\circ\text{C}</math> unless otherwise stated)</b>					
$V_{SD}$	Source-Drain Forward Voltage	$I_S = 0.5\text{ A}, V_{GS} = 0\text{ V}, T = 25^\circ\text{C}$		1.8	V
		$I_S = 0.5\text{ A}, V_{GS} = 0\text{ V}, T = 125^\circ\text{C}$		1.8	

### Thermal Characteristics

Parameter	Description	TYP	Unit
$R_{\theta JC}$	Thermal Resistance, Junction to Case	2.4	$^\circ\text{C}/\text{W}$
$R_{\theta JB}$	Thermal Resistance, Junction to Board	16	$^\circ\text{C}/\text{W}$
$R_{\theta JA}$	Thermal Resistance, Junction to Ambient (Note 1)	56	$^\circ\text{C}/\text{W}$

Note 1:  $R_{\theta JA}$  is determined with the device mounted on one square inch of copper pad, single layer 2 oz copper on FR4 board. See [http://epc-co.com/epc/documents/product-training/Appnote\\_Thermal\\_Performance\\_of\\_eGaN\\_FETs.pdf](http://epc-co.com/epc/documents/product-training/Appnote_Thermal_Performance_of_eGaN_FETs.pdf) for details.

PARAMETER	TEST CONDITIONS	MIN	TYP	MAX	UNIT
<b>Dynamic Characteristics (T<sub>J</sub>= 25°C unless otherwise stated)</b>					
C <sub>ISS</sub>	Input Capacitance		480	540	pF
C <sub>OSS</sub>	Output Capacitance		270	350	
C <sub>RSS</sub>	Reverse Transfer Capacitance		9.2	12	
Q <sub>G</sub>	Total Gate Charge (V <sub>GS</sub> = 5 V)		5	7.5	nC
Q <sub>GD</sub>	Gate to Drain Charge	V <sub>DS</sub> = 100 V, I <sub>D</sub> = 12 A	1.7	2.6	
Q <sub>GS</sub>	Gate to Source Charge		1.3	2	
Q <sub>OSS</sub>	Output Charge	V <sub>DS</sub> = 100 V, V <sub>GS</sub> = 0 V	40	50	
Q <sub>RR</sub>	Source-Drain Recovery Charge		0		

All measurements were done with substrate shorted to source.

Figure 1: Typical Output Characteristics

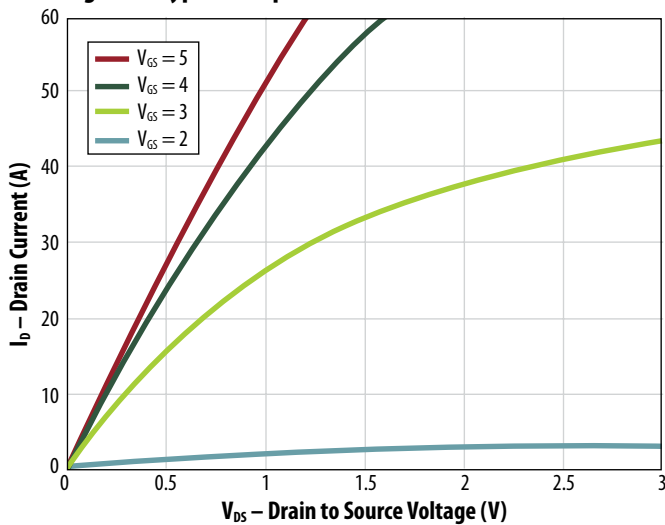

Figure 2: Transfer Characteristics

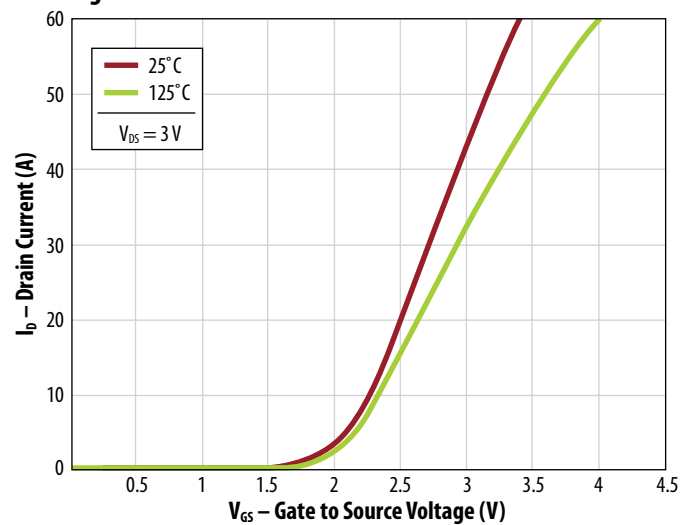

Figure 3: R<sub>DS(ON)</sub> vs V<sub>G</sub> for Various Current

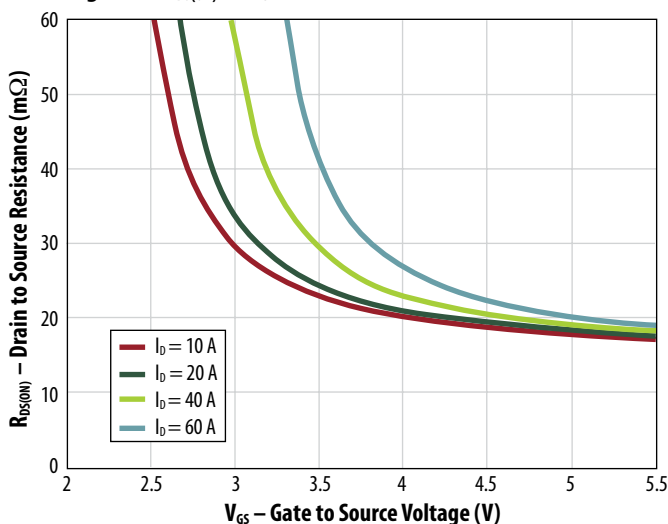

Figure 4: R<sub>DS(ON)</sub> vs V<sub>G</sub> for Various Temperature

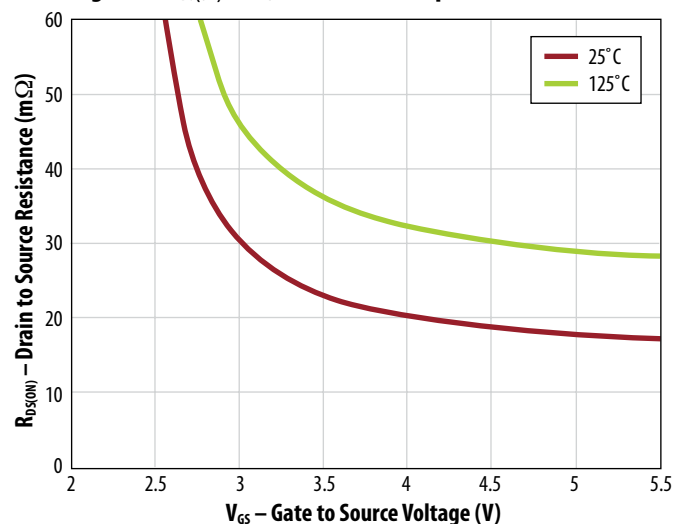

Figure 5: Capacitance

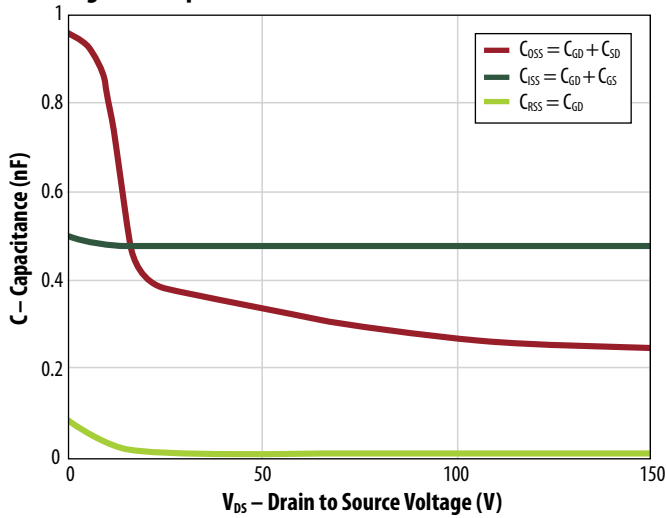

Figure 6: Gate Charge

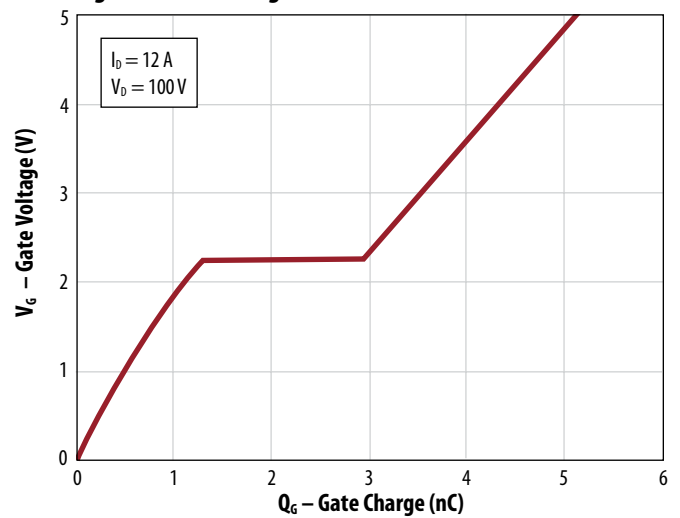

Figure 7: Reverse Drain-Source Characteristics

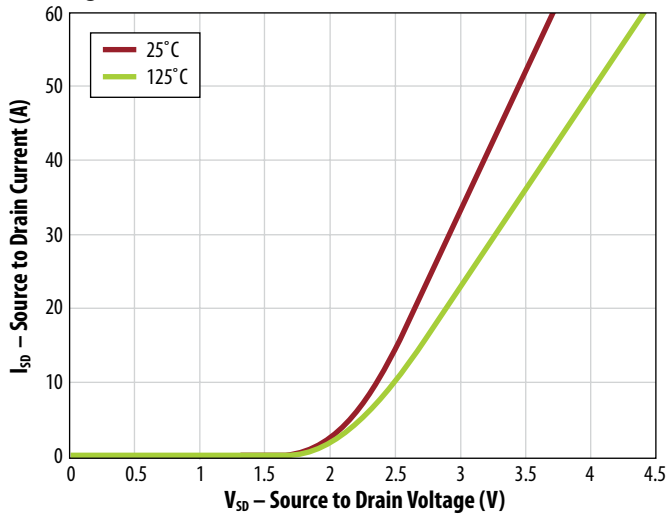

Figure 8: Normalized On Resistance vs Temperature

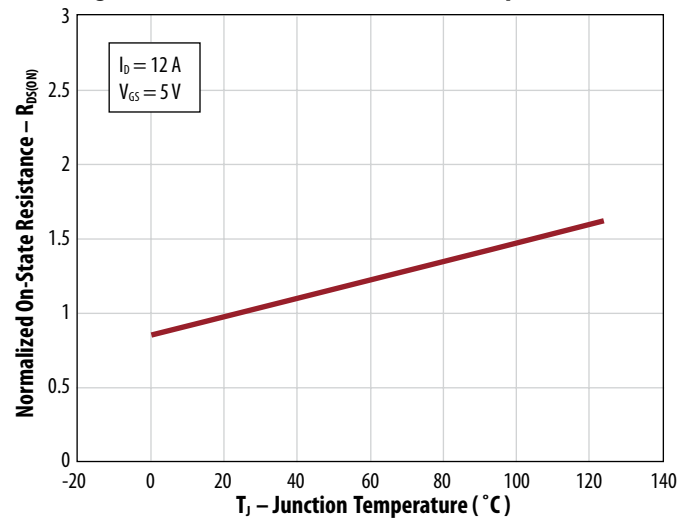

Figure 9: Normalized Threshold Voltage vs Temperature

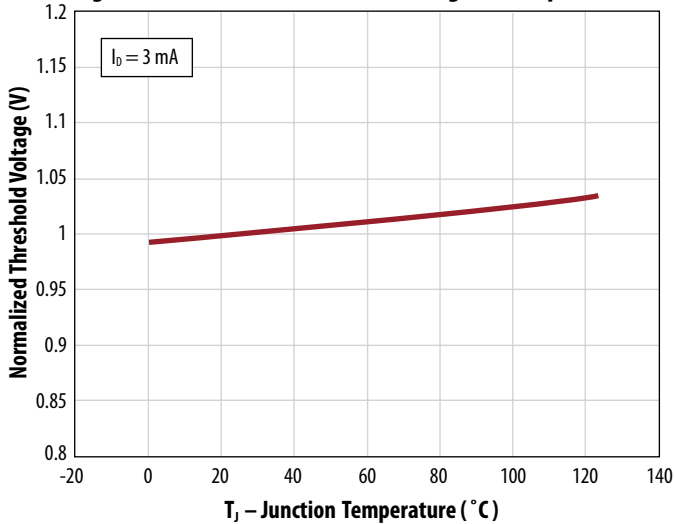
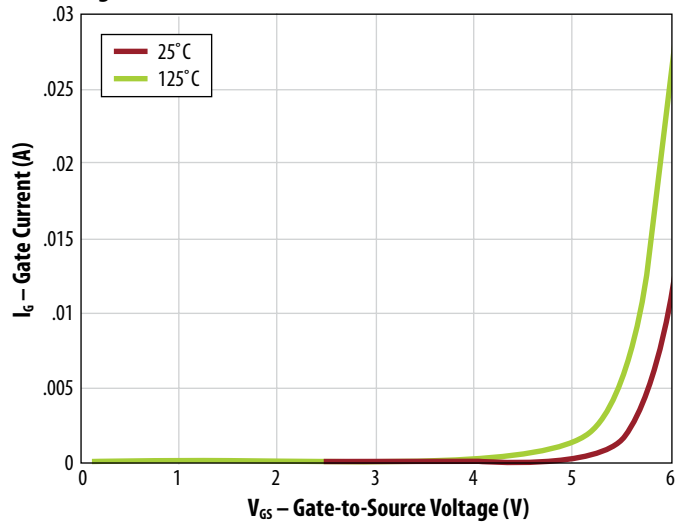

Figure 10: Gate Current



All measurements were done with substrate shorted to source.

Figure 11: Transient Thermal Response Curves

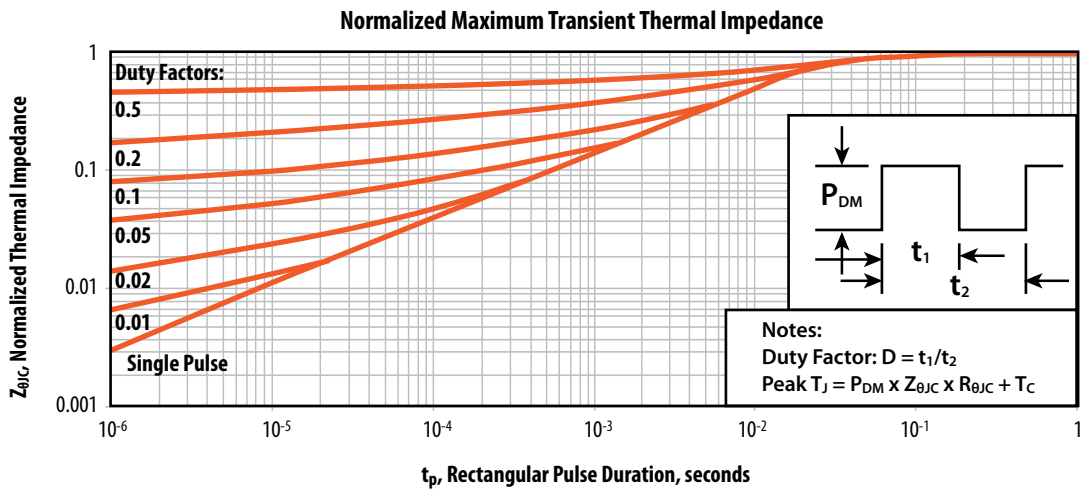
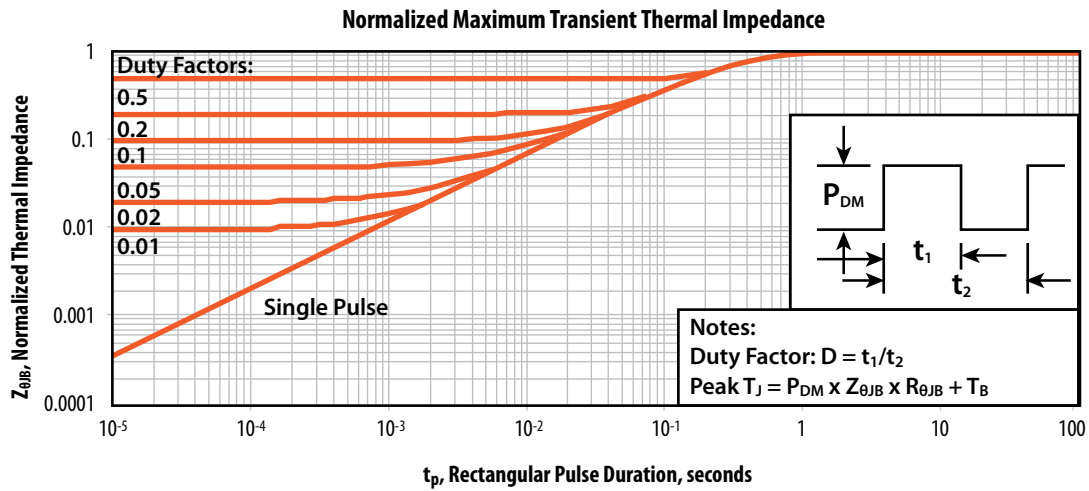
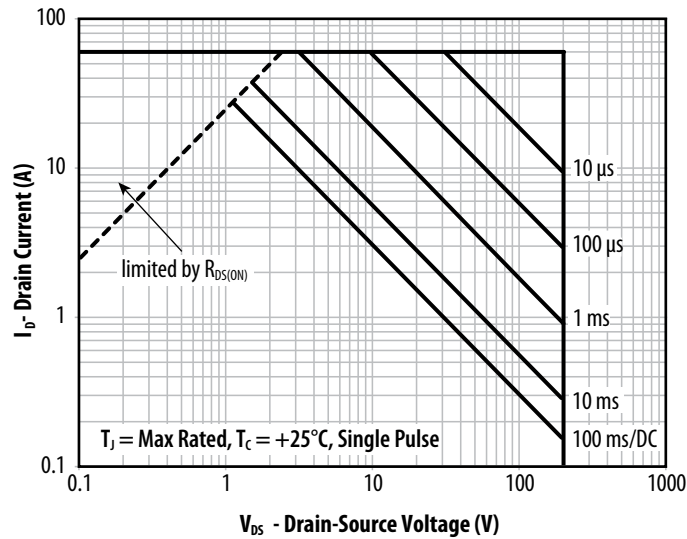
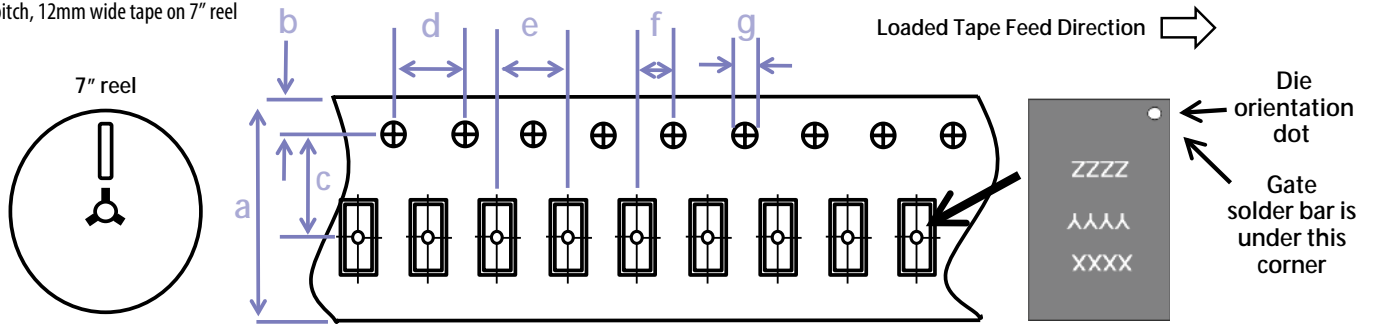

Figure 12: Safe Operating Area



**TAPE AND REEL CONFIGURATION**

4mm pitch, 12mm wide tape on 7" reel



Die is placed into pocket  
solder bar side down  
(face side down)

Dimension (mm)	EPC2818		
	target	min	max
a	12.0	11.9	12.3
b	1.75	1.65	1.85
c (note 2)	5.50	5.45	5.55
d	4.00	3.90	4.10
e	4.00	3.90	4.10
f (note 2)	2.00	1.95	2.05
g	1.5	1.5	1.6

Note 1: Pocket position is relative to the sprocket hole measured as true position of the pocket, not the pocket hole.

**DIE MARKINGS**

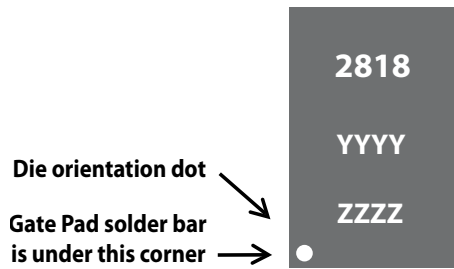

Part Number	Laser Markings		
	Part # Marking Line 1	Lot_Date Code Marking line 2	Lot_Date Code Marking Line 3
EPC2818	2818	YYYY	ZZZZ

**DIE OUTLINE**

Solder Bar View

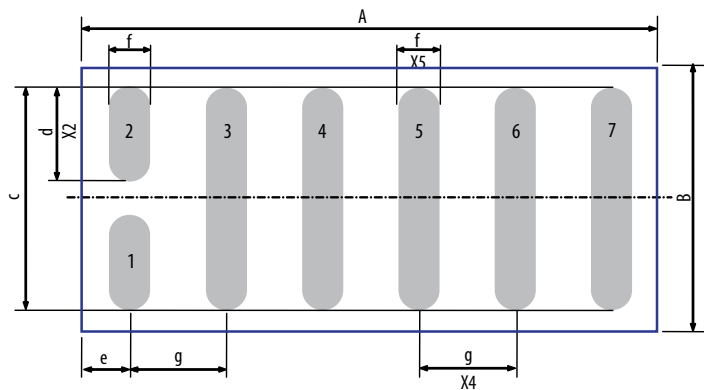

High Lead Bump Finish: 95%Pb/5%Sn

DIM	MICROMETERS		
	MIN	Nominal	MAX
A	3524	3554	3584
B	1602	1632	1662
c	1379	1382	1385
d	577	580	583
e	262	277	292
f	245	250	255
g	600	600	600

Side View

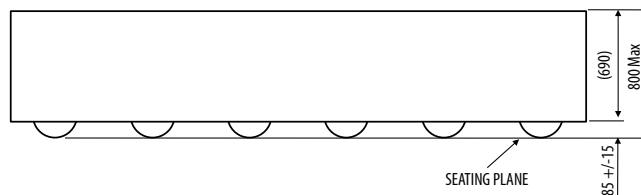

**RECOMMENDED  
LAND PATTERN**  
(units in  $\mu\text{m}$ )

The land pattern is solder mask defined.

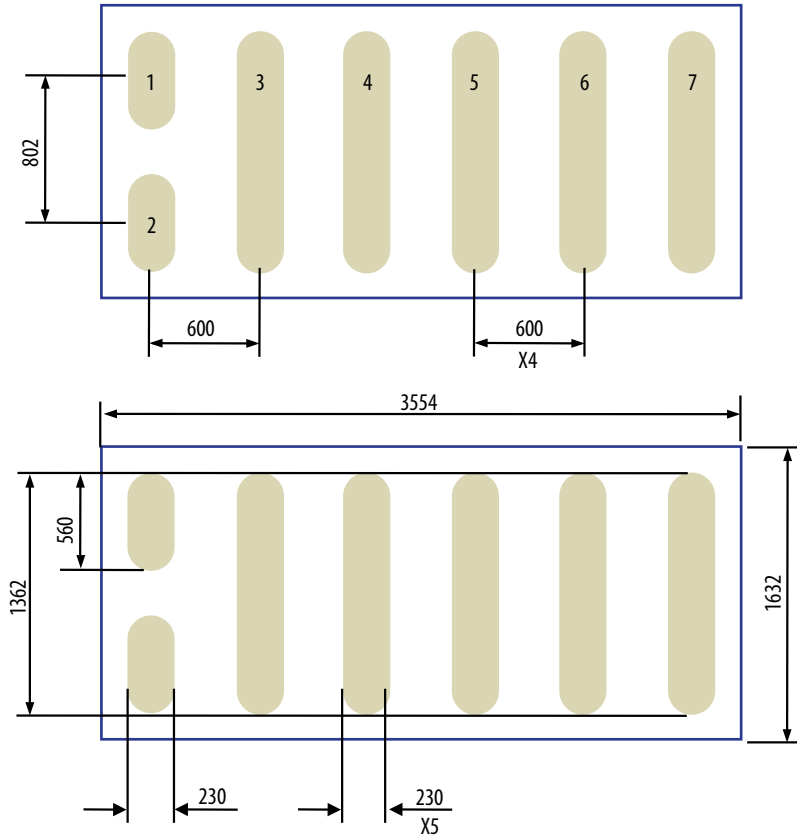

Pad no. 1 is Gate;  
 Pads no. 3, 5, 7 are Drain;  
 Pads no. 4, 6 are Source;  
 Pad no. 2 is Substrate

Efficient Power Conversion Corporation (EPC) reserves the right to make changes without further notice to any products herein to improve reliability, function or design. EPC does not assume any liability arising out of the application or use of any product or circuit described herein; neither does it convey any license under its patent rights, nor the rights of others.

eGaN® is a registered trademark of Efficient Power Conversion Corporation.

U.S. Patents 8,350,294; 8,404,508; 8,431,960; 8,436,398

Information subject to change without notice.

Revised March, 2014