

LSIC2SD120C08

HF RoHS Pb



**Description**

This series of silicon carbide (SiC) Schottky diodes has negligible reverse recovery current, high surge capability, and a maximum operating junction temperature of 175 °C. These diodes series are ideal for applications where improvements in efficiency, reliability, and thermal management are desired.

**Features**

- Positive temperature coefficient for safe operation and ease of paralleling
- 175 °C maximum operating junction temperature
- Excellent surge capability
- Extremely fast, temperature-independent switching behavior
- Dramatically reduced switching losses compared to Si bipolar diodes

**Circuit Diagram TO-252-2L ( DPAK )**

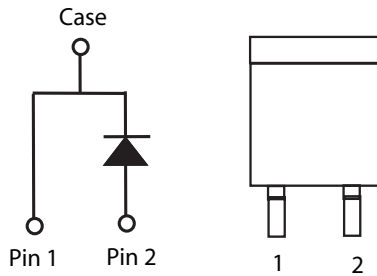

**Applications**

- Boost diodes in PFC or DC/DC stages
- Switch-mode power supplies
- Uninterruptible power supplies
- Solar inverters
- Industrial motor drives
- EV charging stations

**Environmental**

- Littelfuse "RoHS" logo = **RoHS** RoHS conform
- Littelfuse "HF" logo = **HF** Halogen Free
- Littelfuse "PB-free" logo = **Pb** Pb-free lead plating

**Maximum Ratings**

Characteristics	Symbol	Conditions	Value	Unit
Repetitive Peak Reverse Voltage	$V_{RRM}$	-	1200	V
DC Blocking Voltage	$V_R$	$T_j = 25\text{ °C}$	1200	V
Continuous Forward Current	$I_F$	$T_c = 25\text{ °C}$	24.5	A
		$T_c = 135\text{ °C}$	12	
		$T_c = 154\text{ °C}$	8	
Non-Repetitive Forward Surge Current	$I_{FSM}$	$T_c = 25\text{ °C}, T_p = 10\text{ ms}, \text{Half sine pulse}$	65	A
Power Dissipation	$P_{Tot}$	$T_c = 25\text{ °C}$	125	W
		$T_c = 110\text{ °C}$	54	
Operating Junction Temperature	$T_J$	-	-55 to 175	°C
Storage Temperature	$T_{STG}$	-	-55 to 150	°C
Soldering Temperature	$T_{sold}$	-	260	°C

**Electrical Characteristics**

Characteristics	Symbol	Conditions	Value			Unit
			Min.	Typ.	Max.	
Forward Voltage	$V_F$	$I_F = 8 \text{ A}, T_J = 25 \text{ }^\circ\text{C}$	-	1.5	1.8	V
		$I_F = 8 \text{ A}, T_J = 175 \text{ }^\circ\text{C}$	-	2.2	-	
Reverse Current	$I_R$	$V_R = 1200 \text{ V}, T_J = 25 \text{ }^\circ\text{C}$	-	<1	100	$\mu\text{A}$
		$V_R = 1200 \text{ V}, T_J = 175 \text{ }^\circ\text{C}$	-	10	-	
Total Capacitance	C	$V_R = 1 \text{ V}, f = 1 \text{ MHz}$	-	454	-	pF
		$V_R = 400 \text{ V}, f = 1 \text{ MHz}$	-	45	-	
		$V_R = 800 \text{ V}, f = 1 \text{ MHz}$	-	33	-	
Total Capacitive Charge	$Q_C$	$V_R = 800 \text{ V}, Q_C = \int_0^{V_R} C(V) dV$	-	47	-	nC

Footnote:  $T_J = +25 \text{ }^\circ\text{C}$  unless otherwise specified

**Thermal Characteristics**

Characteristics	Symbol	Conditions	Value			Unit
			Min.	Typ.	Max.	
Thermal Resistance	$R_{\theta JC}$	-	-	1.2	-	$^\circ\text{C/W}$

**Figure 1: Typical Forward Characteristics**

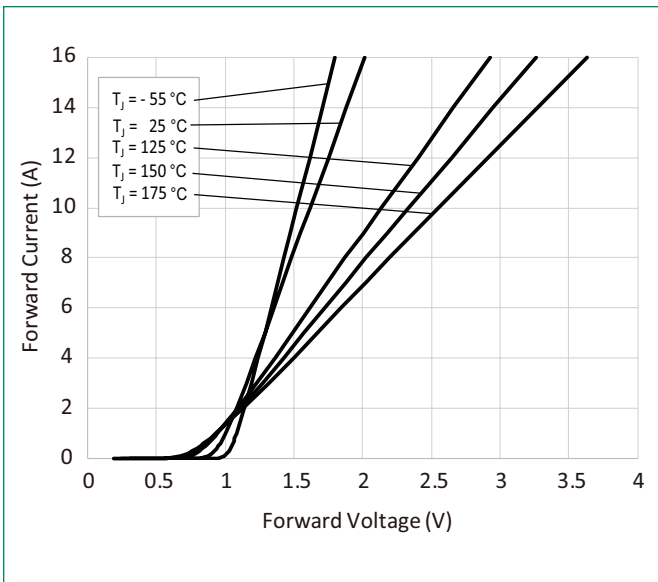

**Figure 2: Typical Reverse Characteristics**

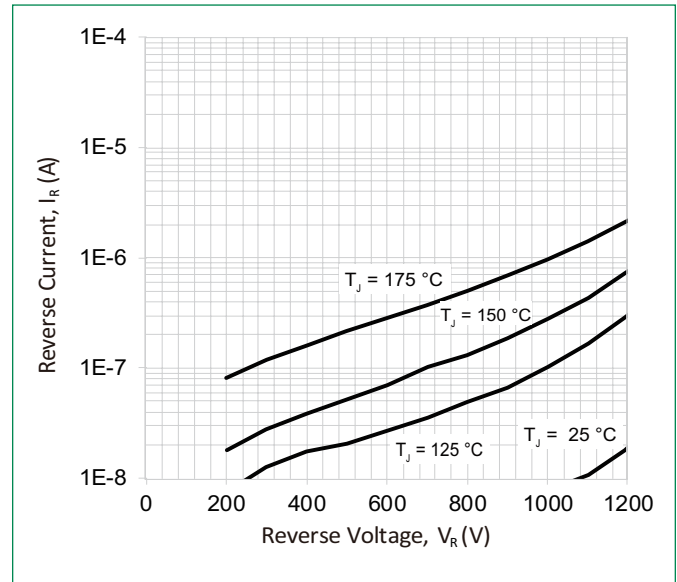

**Figure 3: Power Derating**

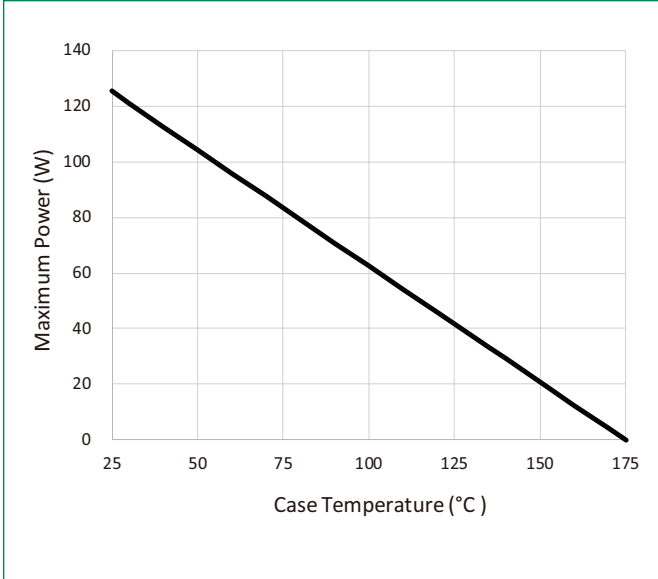

**Figure 4: Current Derating**

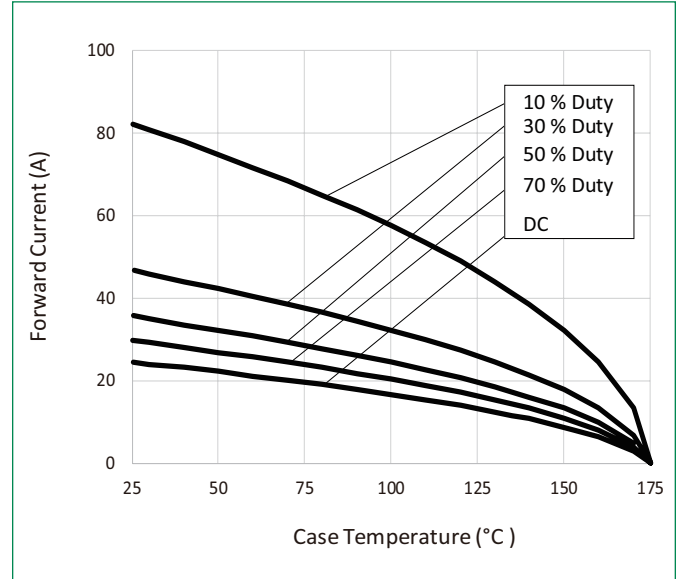

**Figure 5: Capacitance vs. Reverse Voltage**

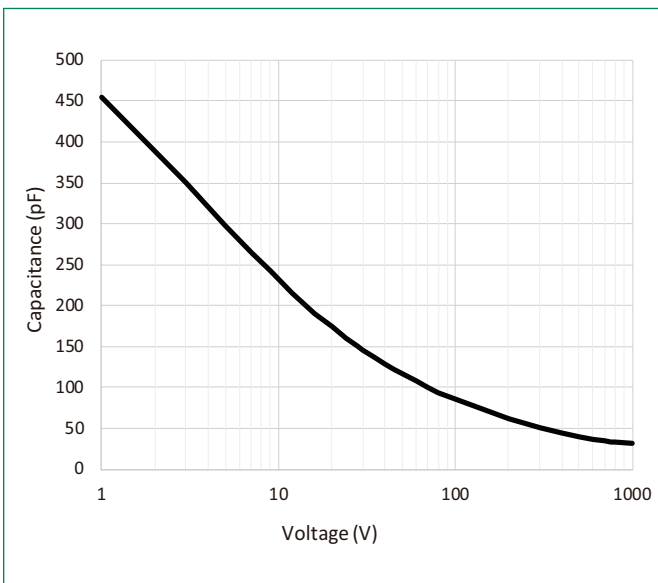

**Figure 6: Capacitive Charge vs. Reverse Voltage**

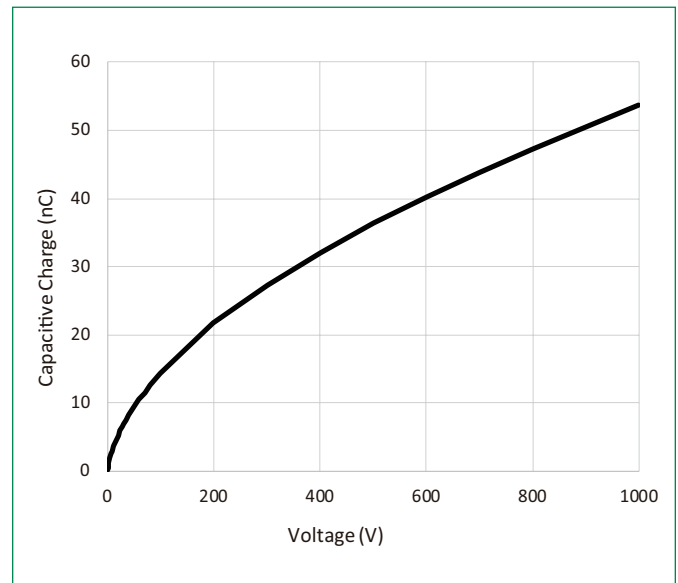

**Figure 7: Stored Energy vs. Reverse Voltage**

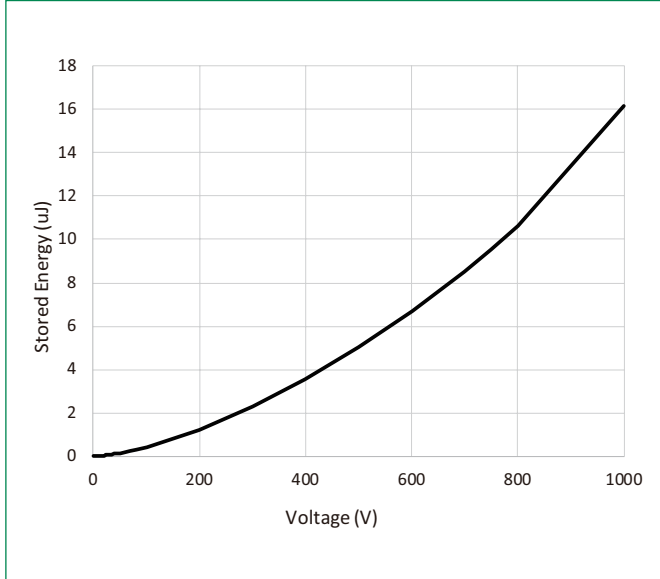

**Figure 8: Transient Thermal Impedance**

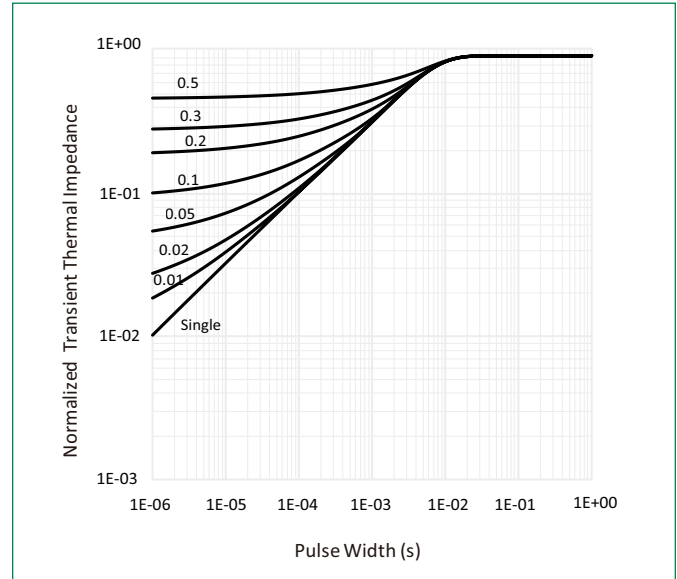

**Part Numbering and Marking System**

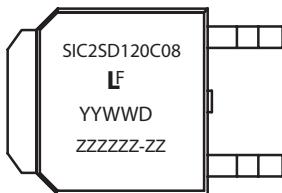

- SIC = SiC Diode
- 2 = Gen2
- SD = Schottky Diode
- 120 = Voltage Rating (1200 V)
- C = TO-252 2-Lead Package
- 08 = Current Rating ( 8 A)
- YY = Year
- WW = Week
- D = Special code (fixed)
- ZZZZZZ-ZZ = Lot Number

**Packing Options**

Part Number	Marking	Packing Mode	M.O.Q
LSIC2SD120C08	SIC2SD120C08	Tape and Reel	2500

**Dimensions TO-252-2L (DPAK)**

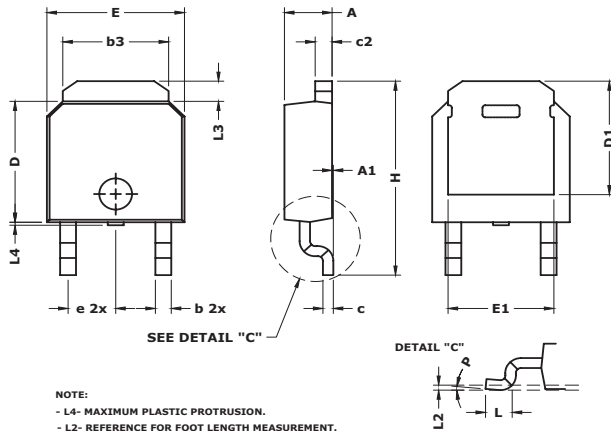

**Recommended Solder Pattern Layout**

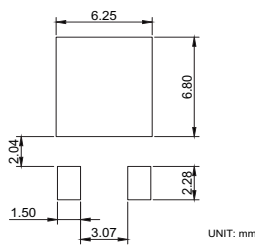

Symbol	Inches			Millimeters		
	Min	Nom	Max	Min	Nom	Max
A	0.085	0.090	0.095	2.16	2.29	2.41
A1	0	0.003	0.005	0	0.08	0.13
b	0.025	0.030	0.035	0.64	0.76	0.89
b3	0.195	0.200	0.215	4.95	5.08	5.46
c	0.018	0.020	0.024	0.46	0.51	0.61
C2	0.018	0.032	0.035	0.46	0.81	0.89
D	0.235	0.240	0.245	5.97	6.10	6.22
D1	0.205	-	-	5.21	-	-
E	0.250	0.260	0.265	6.35	6.60	6.73
E1	0.170	-	-	4.32	-	-
e	0.090 BSC			2.29 BSC		
H	0.370	0.387	0.410	9.40	9.83	10.41
L	0.040	0.045	0.050	1.02	1.14	1.27
L2	0.010 BSC			0.25 BSC		
L3	0.035	-	0.050	0.89	-	1.27
L4	0	-	0.006	0	-	0.15
P	0°	-	8°	0°	-	8°

**Carrier Tape & Reel Specification TO-252-2L (DPAK)**

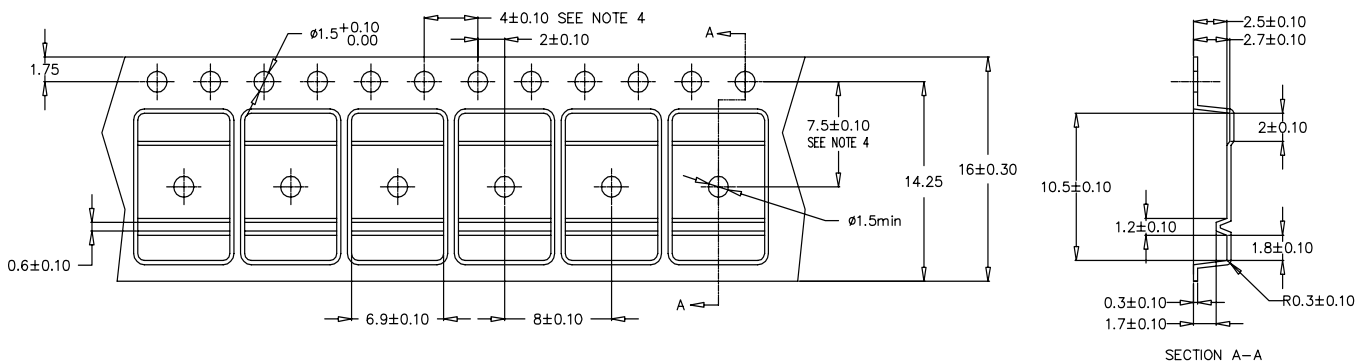

1. Material: Black Conductive Polyester
2. 10 sprocket hole pitch cumulative tolerance  $\pm 0.20$
3. Camber not to exceed 1 mm in 100 mm.
4. Pocket position relative to sprocket hole measured as true position of pocket, not pocket hole.
5. Device orientation: TRL (leads perpendicular to the sprocket)
6. General tolerance is  $\pm 0.10$  mm unless otherwise specified.

**COVER TAPE SPECS:**

- Width : 13.5 mm
- Base Material : less than  $1.2 \times 10^{12}$  ohms/square  
Transparent polyester, static dissipative
- Adhesive Layer : Polyethylene
- Total Thickness : 60 Micron
- Tensile Strength : 4-6 kg/mm<sup>2</sup>
- Elongation : 91%
- Tearing Strength : 11 kg/mm<sup>2</sup>
- Shelf life : 2 years

