

STRUCTURE Silicon Monolithic Integrated Circuit

PRODUCT SERIES Wireless Audio Link LSI for Mobile Phone (FM Stereo Transmitter)

TYPE **BH1425GWL**

FEATURE

- Low voltage Fast Mode I²C-BUS interface.
- Adjustment free wideband PLL frequency synthesizer (76MHz~108MHz).
- Possible to select reference clock frequency freely.
- Possible to select transmission power by serial control.
- Possible to select pre-emphasis time constant by serial control.
- Built-in high performance Low-pass Filter.
- Built-in pilot-tone system FM stereo modulator circuit.
- The transmission frequency is stable because it has PLL system FM transmitter circuit.
- Possible to operate in monaural mode.
- Built-in the sound muting circuit.

○ Absolute Maximum Ratings (Ta=25°C)

Parameter	Symbol	Limits	Unit	Condition
Supply voltage	VCC	-0.3 to +5.5	V	Pin 2, 6, 11, 13, 23, 25
Data input voltage 1	V _{IN-D1}	-0.3 to V _{DDIO} +0.3	V	Pin 16, 19, 20
Data input voltage 2	V _{IN-D2}	-0.3 to +5.5	V	Pin 17, 18
Power dissipation	Pd	960	mW	(NOTE 1)
Storage temperature	Tstg	-55 to +125	°C	



(NOTE 1) To use at a temperature higher than Ta=25°C, derate 9.6mW per 1°C.

Status of this document

The Japanese version of this document is the formal specification. A customer may use this translation version only for a reference to help reading the formal version. If there are any differences in translation version of this document, formal version takes priority.

Application example

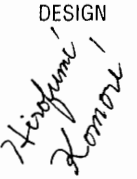
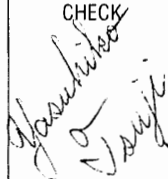
- ROHM cannot provide adequate confirmation of patents.
- The product described in this specification is designed to be used with ordinary electronic equipment or devices (such as audio-visual equipment, office-automation equipment, communications devices, electrical appliances, and electronic toys). Should you intend to use this product with equipment or devices which require an extremely high level of reliability and the malfunction of which would directly endanger human life (such as medical instruments, transportation equipment, aerospace machinery, nuclear-reactor controllers, fuel controllers and other safety devices), please be sure to consult with our sales representative in advance.
- ROHM assumes no responsibility for use of any circuits described herein, conveys no license under any patent or other right, and makes no representations that the circuits are free from patent infringement.

DESIGN	CHECK	APPROVAL	DATE : 2006/05/08	SPECIFICATION No. : TSZ02201-BH1425GWL-1-2
			REV. A	ROHM CO., LTD.

○ Operating Supply Voltage Range

Parameter	Symbol	Limits	Unit	Conditions
Operating supply voltage 1	V_{CC}	2.7 to 4.0	V	Pin 2, 6, 11, 23, 25
Operating supply voltage 2	V_{DDIO}	1.7 to 4.0	V	Pin 13
Operating temperature	T_{por}	-20 to +85	°C	
Audio input level	V_{IN-A}	to -10	dBV	Pin 26, 27
Audio input frequency	f_{IN-A}	20 to 15k	Hz	Pin 26, 27
Transmission frequency	f_{TX}	76.0 to 108.0	MHz	100kHz step
Control terminal "H" level input voltage 1	V_{IH1}	$0.7V_{DDIO}$ to V_{DDIO}	V	Pin 16, 19, 20
Control terminal "H" level input voltage 2	V_{IH2}	$0.7V_{DDIO}$ to +5.5	V	Pin 17, 18
Control terminal "L" level input voltage	V_{IL}	GND to $0.3V_{DDIO}$	V	Pin 16, 17, 18, 19, 20

○ Electrical Characteristics

Unless otherwise specified $T_a=25^{\circ}\text{C}$, $V_{CC}=3.0\text{V}$, $V_{DDIO}=1.8\text{V}$

Signal source : $f_{IN}=1\text{kHz}$, $V_{IN}=-20\text{dBV}$ Common condition : $f_{TX}=90\text{MHz}$, $\Delta f=\pm 75\text{kHz}$, $\tau=50\mu\text{s}$

Parameter	Symbol	Limits			Unit	Condition
		Min.	Typ.	Max.		
Quiescent current	I_Q	14	20	28	mA	Tx power control is 0dB setting.
Power down current	I_{PWD}	—	0	1	μA	BUSEN="L"
Channel separation	Sep	25	40	—	dB	L→R, R→L
Signal to noise ratio	SNR	53	61	—	dB	L+R
		54	62	—	dB	MONO
Total harmonic distortion	THD	—	0.1	0.3	%	L+R
		—	0.1	0.3	%	MONO
Transmission power level	P_{TX}	-9	-6	-3	dBm	Tx power control is 0dB setting.
Pilot modulation rate	M_P	7	11	15	%	L+R
"H" level input current	I_{IH}	—	—	1.0	μA	Pin 16, 19, 20 $V_{IN}=3\text{V}$
"L" level input current	I_{IL}	-1.0	—	—	μA	Pin 16, 19, 20 $V_{IN}=0\text{V}$
"L" level output voltage	V_{OL}	—	—	$0.2V_{DDIO}$	V	Pin 18 $I_O=3\text{mA}$

◎ This product is not designed for protection against radioactive rays.

◎ The specification of transmission output level be based on the Radio Law in every country and the area.

○ PACKAGE OUTLINE

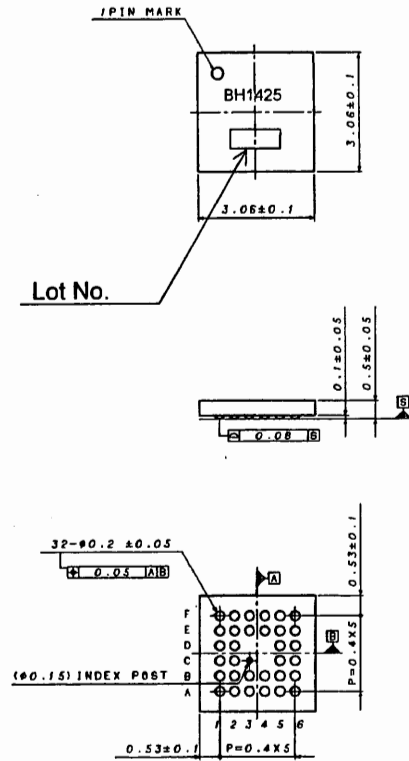

UCSP50L3

(UNIT : mm)

○ BLOCK DIAGRAM

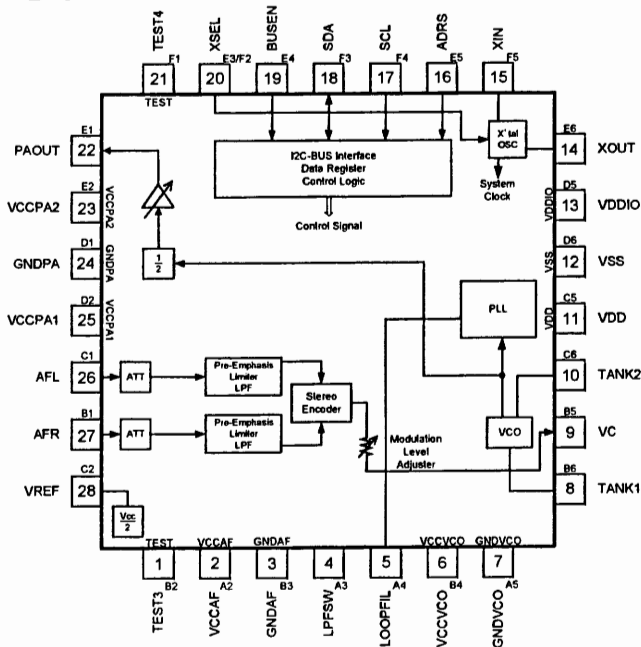

○ PIN ASSIGNMENT

(BOTTOM VIEW)

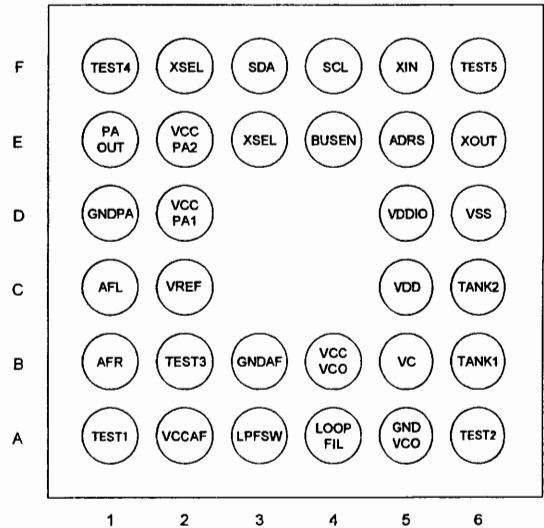

* Please use TEST1,TEST2,TEST3,TEST4 and TEST5 as open terminal.

○ Cautions on use

(1) Absolute maximum ratings

If applied voltage, operating temperature range, or other absolute maximum ratings are exceeded, the LSI may be damaged. Do not apply voltages or temperatures that exceed the absolute maximum ratings. If you think of a case in which absolute maximum ratings are exceeded, enforce fuses or other physical safety measures and investigate how not to apply the conditions under which absolute maximum ratings are exceeded to the LSI.

(2) GND potential

Make the GND pin voltage such that it is the lowest voltage even when operating below it. Actually confirm that the voltage of each pin does not become a lower voltage than the GND pin, including transient phenomena.

(3) Thermal design

Perform thermal design in which there are adequate margins by taking into account the allowable power dissipation in actual states of use.

(4) Shorts between pins and misinstallation

When mounting the LSI on a board, pay adequate attention to orientation and placement discrepancies of the LSI. If it is misinstalled and the power is turned on, the LSI may be damaged. It also may be damaged if it is shorted by a foreign substance coming between pins of the LSI or between a pin and a power supply or a pin and a GND.

(5) Operation in strong magnetic fields

Adequately evaluate use in a strong magnetic field, since there is a possibility of malfunction.

— Jisso Information —

Package : UCSP50L3

< A table of contents >

1. Structure and materials	1 / 4 page
2. Tape and Reel informations	1 / 4 ~ 3 / 4 page
3. Storage conditions	3 / 4 page
4. Marking lot number	3 / 4 page
5. Recommended soldering conditions	3 / 4 page
6. Footprint dimensions	4 / 4 page
7. Regarding the underfill material	4 / 4 page
8. External dimensions	4 / 4 page

1. Structure and materials

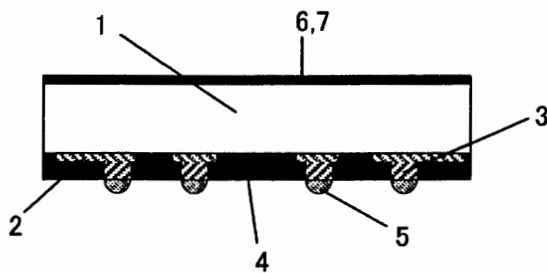

Fig. 1 Structure

No.	Item	Materials
①	Die	Silicon
②	Cu Layer	Cu
③	Cu Post	Cu
④	Encapsulation	Epoxy Resin
⑤	Ext. terminal	Sn-3Ag-0.5Cu Solder
⑥	Encapsulation	Polyamide-imide Resin
⑦	Marking	Laser Marking

Dehydrated weight : 0.009g

2. Tape and Reel information

2. 1. Packing specification

Tape	Embossed carrier tape
Quantity	2,500pcs/Reel
Direction of feed	E2 (See Fig. 2)

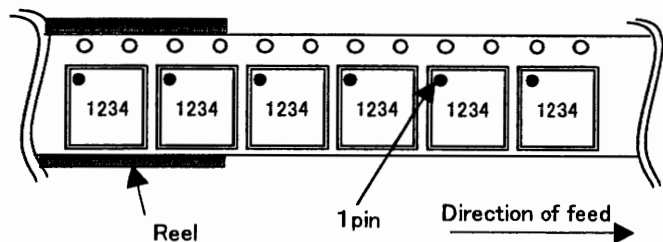

Fig. 2 Typical Tape and Reel configuration

2. 2. Tape and Reel specification

2. 2. 1. Tape and reel dimensions (See the table on page 2/4)

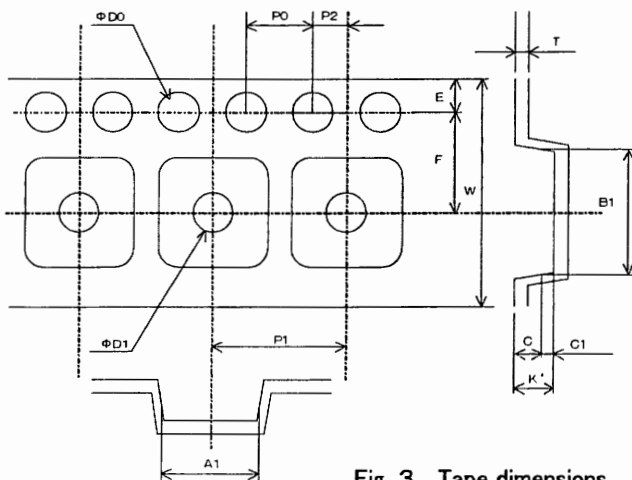

Fig. 3 Tape dimensions

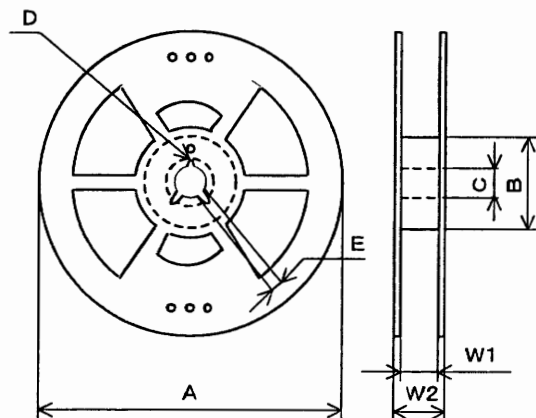

Fig. 4 Reel dimensions

DESIGN <i>Hirofumi Komori</i>	CHECK <i>Yasuhiko Saito</i>	APPROVAL <i>Coon</i>	DATE: 2006. 05.08	SPECIFICATION No. : TSZ02201-BH1425GWL-1-2
REV. A			ROHM CO.,LTD.	

(Tape dimensions)

A1	B1	C	C1	D0	D1	E	F	K'	P0	P1	P2	T	W
3.40 ±0.1	3.40 ±0.1	(0.60)	(0.25)	Φ1.5 +0.1 -0	Φ1.5 +0.1 -0	1.75 ±0.1	5.5 ±0.1	0.85 ±0.1	4.0 ±0.1	8.0 ±0.1	2.0 ±0.1	0.3 ±0.05	12.0 ±0.3

(Reel dimensions)

A	B	C	D	E	W1	W2
Φ330	50 MIN	13.0 ±0.2	20.2 MIN	1.5 MIN	13.4 ±1.0	17.4 ±1.0

2. 3. Leader and Trailer

2. 3. 1. Leader

No component pockets are 25 pockets or more.

2. 3. 2. Trailer

No component pockets are 10 pockets or more.

Tape is free from reel.

2. 4. Label for Reel and Box

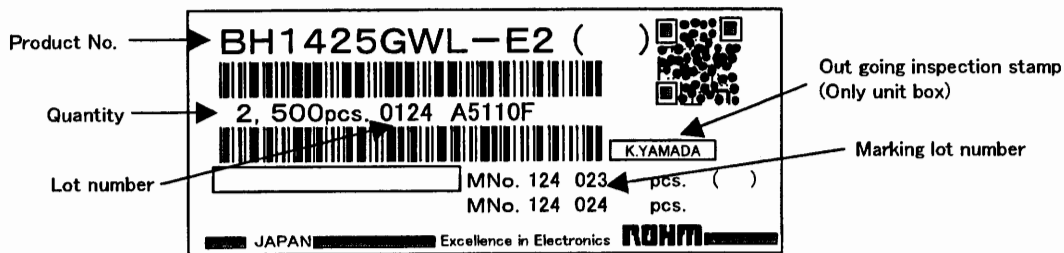

Fig. 5 Label example

2. 5. Packing style

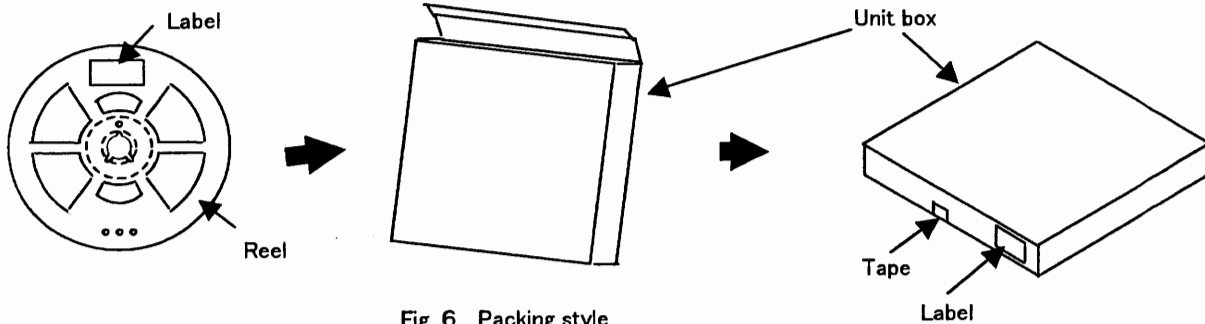

Fig. 6 Packing style

2. 6. Shipping style

5 unit boxes or less per shipping box

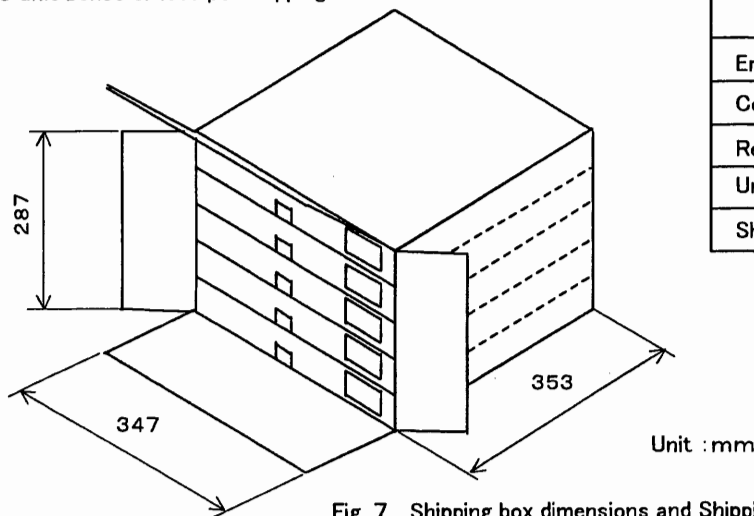

Fig. 7 Shipping box dimensions and Shipping style

2. 7. Packing materials

Item	Material
Embossed carrier tape	PS
Cover tape	PET + PE
Reel	PS
Unit box	Cardboard
Shipping box	Cardboard

2. 8. Others

2. 8. 1. Peelback strength

Cover tape peelback strength is 0.2~0.7N.

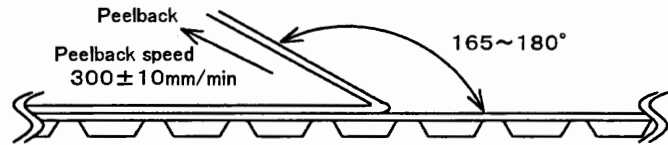

Fig. 8 Test method

2. 8. 2. Dropouts

- (1) No consecutive dropouts.
- (2) A maximum 0.1% of specified number of products in each packing may be missing.

3. Storage conditions

3. 1. Storage environment

Recommended storage conditions are as follows :

- Temperature : 5~30°C
- Humidity : 40~70% RH

3. 2. Storage period

-Specified storage period : 1 year

3. 3. Specified storage period until soldering

This package does not require additional drying treatment as long as the moisture condition at the mounting process is within our recommended mounting condition.

4. Marking lot number

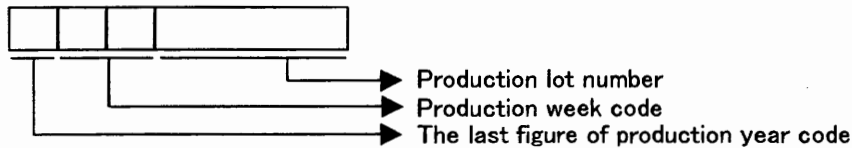

5. Soldering conditions

5. 1. Recommended temperature profile for reflow

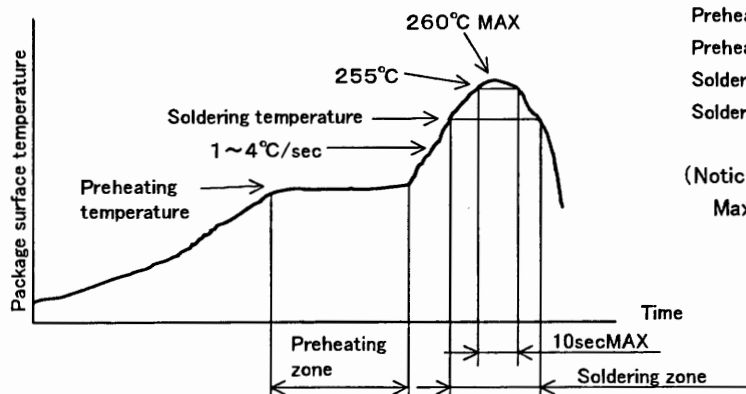

- Preheating temperature : 130°C~190°C
- Preheating zone : 120sec MAX
- Soldering temperature : 220°C~230°C
- Soldering zone : 60sec MAX

(Notice)
Maximum 2-times soldering

5. 2. About mounting with Sn-Pb solder paste.

Mounting with Sn-Pb solder paste is not recommended because it has a possibility of reducing reliability to connect with Sn-3.0Ag-0.5Cu solder balls.

5. 3. The wave soldering method is not supported.

5. 4. Partial heat supply method (by soldering iron) is not supported.

6. Footprint dimensions (Optimize footprint dimensions to the board design and soldering condition)

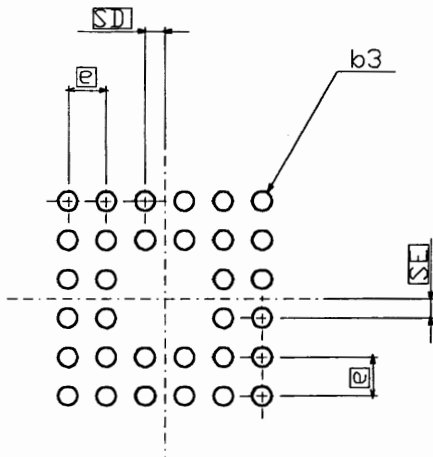

Symbol	Reference Value
e	0.40
b3	0.20
SD	0.20
SE	0.20

(Unit: mm)

7. Regarding the underfill material

There are some cases that the underfill material is applied as purpose to reinforce the soldered junction of the package. Since the mount reliability depends on the resin material or coating condition, it may deteriorate on the contrary. Therefore, it is necessary to evaluate it sufficiently for its application.

In term of the coating condition, it is preferable that there is an enough material beyond the each four sides of a package.

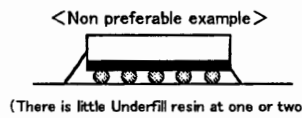
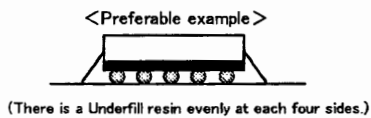

8. External dimintions

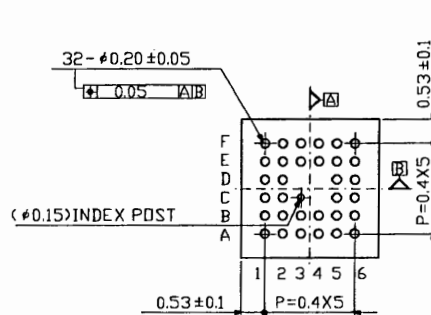
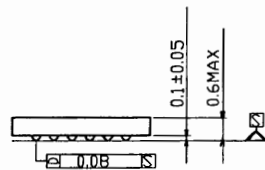
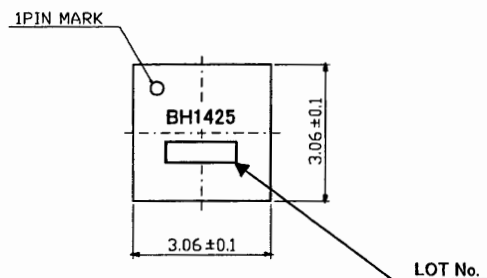

(Unit: mm)