

General Description

This AP1694A Triac Dimmable GU10 12V/400mA Buck LEDs driver EV board use tapped transformer to increasing power conversion turn on duty cycle, boost current back to LED during ratio of tapped winding. Also the bigger gauge wire can be used as well as the large inductance can be suitable in switching loop which can reduce the switching current and the lower forward drop so that SBR diode can be used which can reduce the power consumption on the diodes.

Key Features

- Typical 3% to 95% Dimming performance (Depends on dimmers brands)
- Boundary conductive switching mode
- Simple adjustable Constant Current
- Inductor Short Protection
- Low BOM cost
- PFC >0.9 & low THD.
- 200 ~265V_{AC} input range
- >77% Efficiency
- With open, short, and wrong polarity LED protection

Applications

- GU10 LED Offline small size bulb
- Candle size LED lamp
- Desktop lamps
- Under the counter lamps

AP1694A EV11 Specifications

Parameter	Value
Input Voltage	200 to 265V _{AC}
PFC	> 0.9
LED Current	400mA (Adjustable)
LED Voltage	12V
Efficiency	>77%
Number of LEDs	4 LEDs in series (Under Tested)
XYZ Dimension	28.5 x 16.5 x 14.5mm
ROHS Compliance	Yes

Evaluation Board



Figure 1: Top View

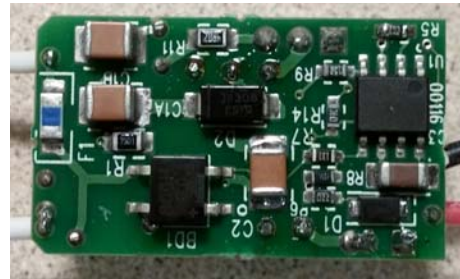

Figure 2: Bottom View

Connection Instructions

Input Voltage: 230V_{AC} (AC+, AC-)
LED Outputs: LED+ (Red), LED- (Black)

WHY USE DIODES TAPPED TRANSFORM STRUCTURE

The traditional Buck converter turn on time is inverse proportion with input voltage.

$V_o = D \times V_{in}$. The duty cycle will be getting smaller when the input voltage goes higher.

Example: $V_o=12V$, $V_{in}= 120V_{AC}$, $F_s= 75kHz$.

$$D = V_o/V_{in} * \sqrt{2} = 12V/120V * 1.414 = 0.07$$

$$T_{on}=D/F_s = 0.07/ 75kHz =0.933\mu s. T=1/F_s =13.33\mu s$$

Since the T_{on} time is too short in the duty cycle; therefore there is not enough current passing through the LEDs and charging the inductor. In result, it caused the efficiency to be lower.

In order to solve this issue - use the Diodes tapped transformer to boost the output current & increase the T_{on} time in the duty cycle.

With the “new tapped” transformer, the Duty cycle will be:

D is original duty cycle = $V_o/V_{in} * 1.414$, $n = N_A + N_p/N_A$ & $L = L_p + L_A$,

$$V_o/V_{in} = D' / (D' + n(1-D')), \text{ If } N_A=40T_s, N_p=100T_s, n=3.5$$

$$D' = nV_o / (V_{in} + (n-1)V_o) = 0.21 \text{ The duty cycle almost increased by 3 times.}$$

The Efficiency will increase about 4 to 5% (before the Efficiency was about 72% now is 77%) comparing with the “none tapped” transformer.

DIODES TAPPED TRANSFORMER DESIGN

AP1694A 230V_{AC} Buck tapped 12V 400mA Transformer Spec

1) Bobbin

EEP10 4+4 pin

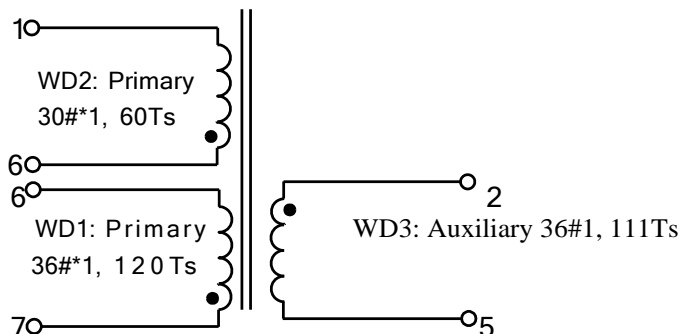

2) Transformer Parameters

1. Primary Inductance (Pin1-Pin7, all other windings are open)
 $L_p = 1.5\text{mH} \pm 5\% @ 1\text{kHz}$
2. Primary Winding Turns: $N_p = 120\text{Ts (Pin 7-Pin 6)} + 60\text{Ts (Pin 6 to Pin 1)}$
3. Auxiliary Winding Turns (Pin2- Pin5): $N_A = 111\text{Ts (Pin 2 to Pin 5)}$

3) Transformer Winding Construction Diagram

Winding Number	Windings	Winding Specification
1	WD1-Primary Winding	Start at Pin 7, wind 120 turns of single $\Phi 34\#$ wire and finish on Pin 6.
	WD2-Primary Winding	Start at Pin 6, wind 60 turns of single $\Phi 30\#$ wire and finish on Pin 1.
2	Insulation	2 Layers of insulation tape
3	WD3-Auxiliary Winding	Start at Pin 2, wind 111 turns of single $\Phi 36\#$ wire and finish on Pin 5.
4	Insulation	2 Layers of insulation tape

Bill of Material

#	Name	QTY	Part number	Manufacturer	Description
1	U1	1	AP1694AS-13	Diodes Inc	LED Driver, SO7
2	T1	1	EL1004R	Elite Electronics	EE10, Transformer
3	BD1	1	HD06-T	Diodes Inc	Bridge Rectifiers 0.8A 600V
4	D1	1	DFLF1800-7	Diodes Inc	Rectifier 1A/800V
5	D2	1	B1100B	Diodes Inc	Rectifier 1A/100V
6	D3	1	MMSZ5250B-7-F	Diodes Inc	Zener Diode, 20V
7	F1	1	C1Q1	Bel Fuse	Fuse, 1A/125V
8	Q1	1	AOU3N60	Alpha Omega	MOSFET N-CH 600V 3A IPAK
9	Q2	1	FMMT458	Diodes Inc	MOSFET N-CH 400V 0.2A SOT-23
10	L1	1	LPS6235-565MRB	Coilcraft	5.6mH/150mA
11	C1A, C1B, C2	3	C1210X104K501T	Holystone	CAP CER 1210 0.1μF 500V X7R
12	C3	1	GMK316BJ106KL-T	Taiyo Yuden	CAP CER 10μF 35V X5R 1206
13	C4	1	EEU-FR1E331B	Panasonic	CAP 330μF/25V (8 x 13mm)
14	C6	1	C1206X0683K501T	Holystone	CAP CER 1206 0.068μF 500V X7R
15	R1	1	RC0805FR-077K5L	Yageo America	RES 7.5KΩ 1/8W 1% 0805 SMD
16	R2	1	FMP100JR-52-330	Yageo America	RES 330Ω 1W 5% FMP100
17	R3A, R3B	2	9T12062A4703FBHFT	Yageo America	RES 470KΩ 1/8W 1% 1206 SMD
18	R4	1	RC1206FR-075K1L	Yageo America	RES 5.1KΩ 1/8W 1% 1206 SMD
19	R5	1	RC0805FR-0715KL	Yageo America	RES 15.0KΩ 1/8W 1% 0805 SMD
20	R6	1	RC0805JR-0722RL	Yageo America	RES 22Ω 1/8W 1% 0805 SMD
21	R7	1	RC0805FR-0711KL	Yageo America	RES 11.0KΩ 1/8W 1% 0805 SMD
22	R8	1	RC0805FR-0756KL	Yageo America	RES 75KΩ 1/8W 1% 0805 SMD
23	R9	1	RC0805FR-071K5L	Yageo America	RES 1.5KΩ 1/8W 1% 0805 SMD
24	R10, R11	2	MCR10ERTFL4R02	Rohm	RES 4.02Ω 1/8W 1% 0805 SMD
25	R12	1	RC1206FR-075K1L	Yageo America	RES 5.1KΩ 1/8W 1% 1206 SMD
26	R13	1	RC0805FR-0730K0L	Yageo America	RES 30KΩ 1/8W 1% 0805 SMD
27	R14	1	RC0603JR-0710KL	Yageo America	RES 10KΩ 1/8W 1% 0603 SMD
28	Rf	1	FMP100JR-52-680	Yageo America	RES 68Ω 1W 1% FMP
29	Rm	1	MOV-07D431KTR	Bournes	MOV, 275VAC

Functional Performance

Manuf	Board Type	V _{IN} (V _{AC})	PFC	P _{IN} (W)	V _{LED} (V)	I _{LED} (mA)	P _{LED} (W)	η _{LED} (%)	Efficiency (%)	A _{thd} (%)
Diodes Inc	AP1694AEV11 Module Board	200	0.918	6.03	11.32	406.0	4.60	1.50	76.22	22.0
		210	0.911	6.04	11.31	407.0	4.60	1.75	76.19	22.0
		220	0.903	6.05	11.29	408.9	4.62	2.22	76.31	23.0
		230	0.900	6.08	11.28	410.0	4.62	2.50	76.03	24.0
		240	0.889	6.10	11.27	411.0	4.63	2.75	75.93	25.0
		250	0.881	6.12	11.26	412.0	4.64	3.00	75.78	25.0
		265	0.872	6.15	11.25	413.5	4.65	3.38	75.65	26.0

Functional Performance

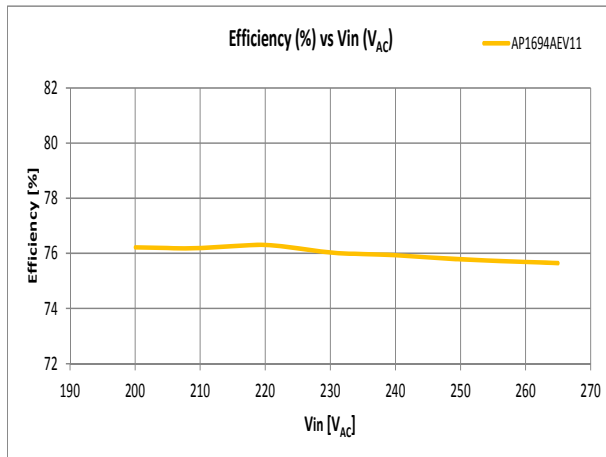

Figure 5. Efficiency vs. Vin

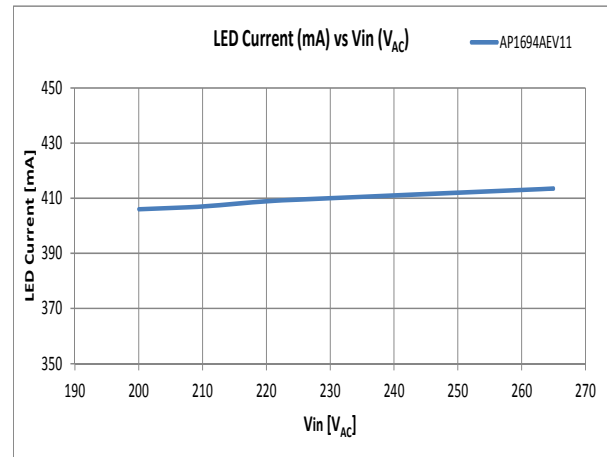

Figure 6. LED Current vs. Vin

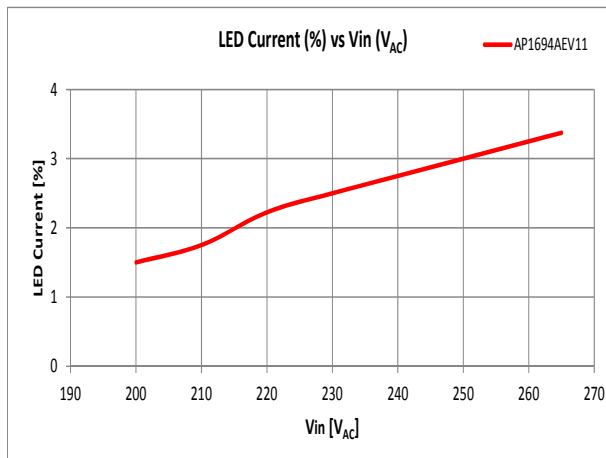

Figure 7. LED Current Line Regulation

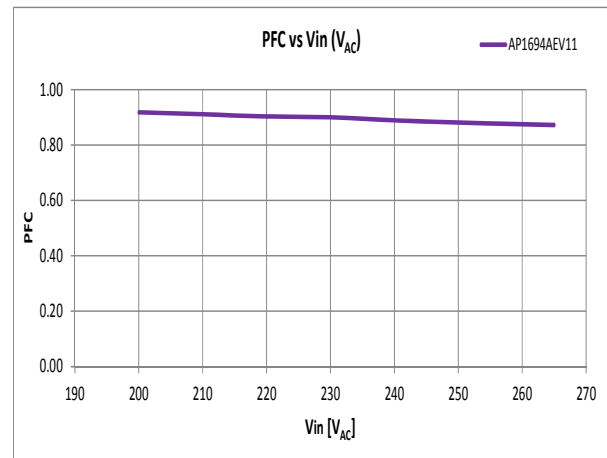

Figure 8. PFC vs. Vin

Performance Waveforms

All of the Channel 1 (VIN) measurement used a 100:1 probe shown in a 2V/division scale.

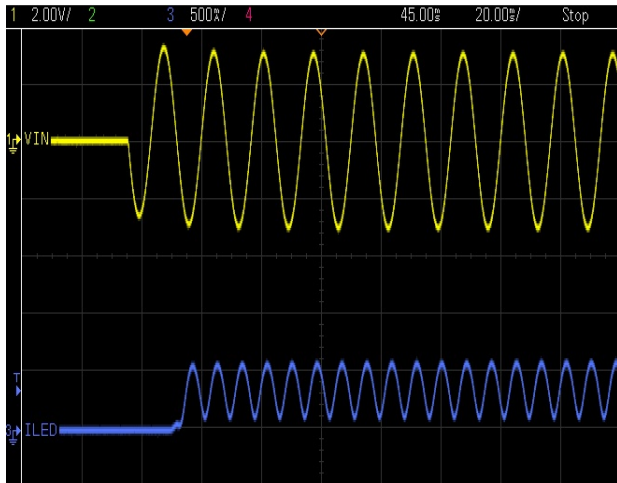

Figure 9. Turn on time (20mS) at 230V_{AC} input

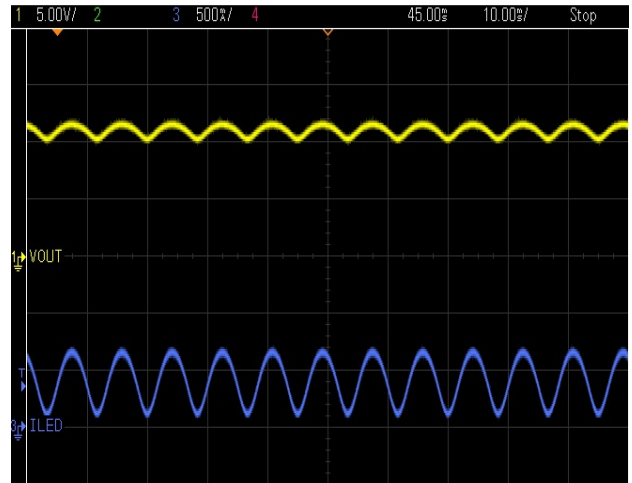

Figure 10. Output Voltage & Current at 230V_{AC}



Figure 11. Input AC voltage vs. output current

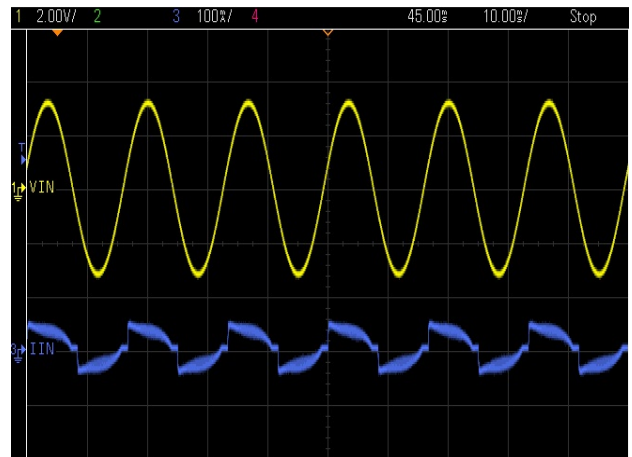

Figure 12. Input AC voltage vs. input AC current

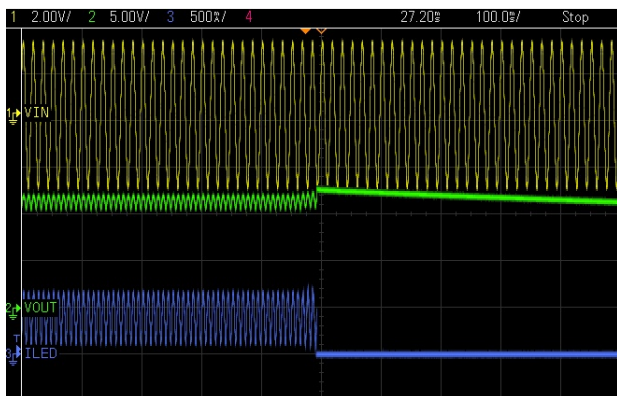

Figure 13. LED open protection

AP1694AEV11 with Panasonic 230V_{AC} dimmer test data

230V _{AC} Dimmer	V _{in} (V _{AC})	V after dimmer	Arms (mA)	Pin(W)	PFC (in)	THD(%)	Vout (V)	Iled (mA)	Pout (W)	Eff (%)	Dimming range (%)	Flicker?
Panasonic (Model # WMS549, 400W)	230V _{AC}	223.6	40.53	5.802	0.640	29.15	11.137	367.90	4.0973	70.62	100.00	✓
		211.5	46.51	5.774	0.540	55.40	11.089	348.20	3.8612	66.87	94.65	✓
			51.16	5.614	0.475	45.56	11.045	330.60	3.6515	65.04	89.86	✓
			55.06	5.457	0.437	46.50	11.008	308.40	3.3949	62.21	83.83	✓
			91.68	5.175	0.245	46.78	10.957	281.90	3.0888	59.69	76.62	✓
		158.1	93.72	5.036	0.236	53.50	10.919	260.10	2.8400	56.39	70.70	✓
			94.25	4.848	0.222	54.53	10.886	241.30	2.6268	54.18	65.59	✓
			94.22	4.617	0.213	56.55	10.848	220.30	2.3898	51.76	59.88	✓
			95.19	4.417	0.201	63.70	10.814	199.94	2.1622	48.95	54.35	✓
		108.8	95.36	4.136	0.190	79.22	10.775	179.08	1.9296	46.65	48.68	✓
			94.85	3.895	0.179	96.77	10.738	159.27	1.7102	43.91	43.29	✓
			94.33	3.626	0.168	95.40	10.709	141.01	1.5101	41.65	38.33	✓
			92.53	3.261	0.153	97.99	10.701	119.35	1.2772	39.16	32.44	✓
		61.0	88.27	2.860	0.141	114.50	10.649	100.38	1.0689	37.38	27.28	✓
			84.88	2.418	0.125	129.90	10.593	81.47	0.8630	35.69	22.14	✓
			81.97	2.052	0.109	157.60	10.521	59.61	0.6272	30.56	16.20	✓
25.3	77.99	1.610	0.090	168.70	10.450	41.53	0.4340	26.96	11.29	✓		
	40.49	1.351	0.145	185.21	10.422	35.98	0.3750	27.76	9.78	✓		

Note: ✓ = No Flicker

EMC test result

Conductive emission noise level (Pass with 15db margin)

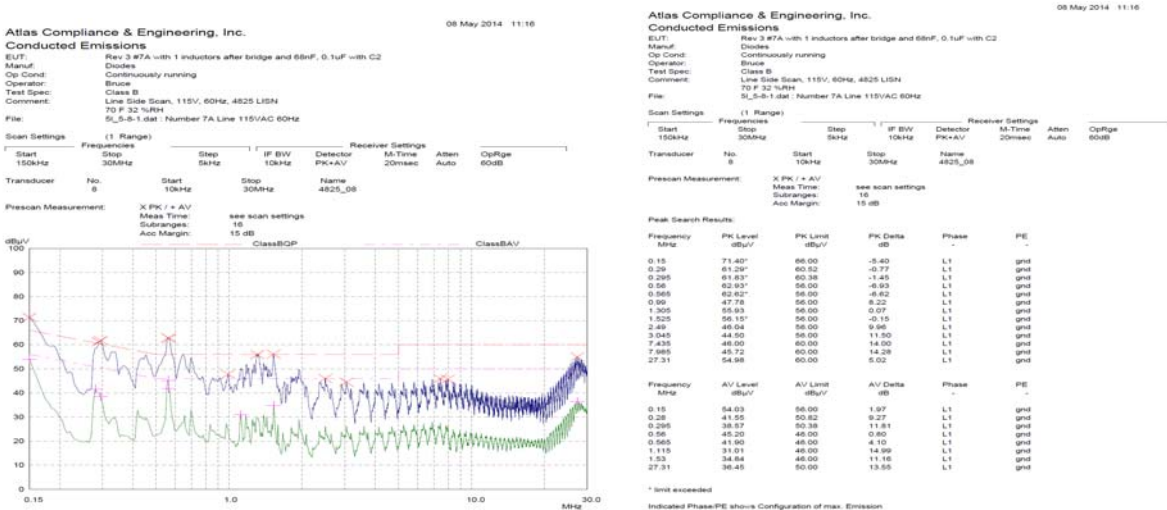

Atlas Compliance & Engineering, Inc.
08 May 2014 11:22
Conducted Emissions
EUT: Rev 3 #7A with 1 inductors after bridge and 68nF, 0.1uF with C2
Manuf: Diodes
Op Cond: Continuously running
Operator: Bruce
Test Spec: Class B
Comment: Neutral Side Scan, 115V, 60Hz, 4825 LISN
70 F 32 %RH
File: Sn_S-8-1.dat : Number 7A Neutral 115VAC 60Hz

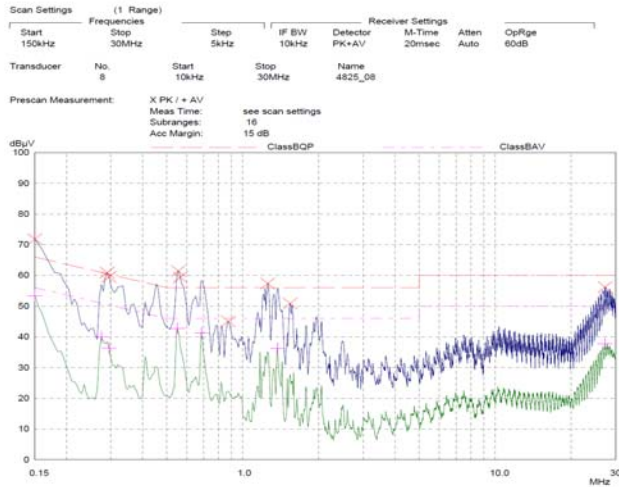

Atlas Compliance & Engineering, Inc.
08 May 2014 11:22
Conducted Emissions
EUT: Rev 3 #7A with 1 inductors after bridge and 68nF, 0.1uF with C2
Manuf: Diodes
Op Cond: Continuously running
Operator: Bruce
Test Spec: Class B
Comment: Neutral Side Scan, 115V, 60Hz, 4825 LISN
70 F 32 %RH
File: Sn_S-8-1.dat : Number 7A Neutral 115VAC 60Hz

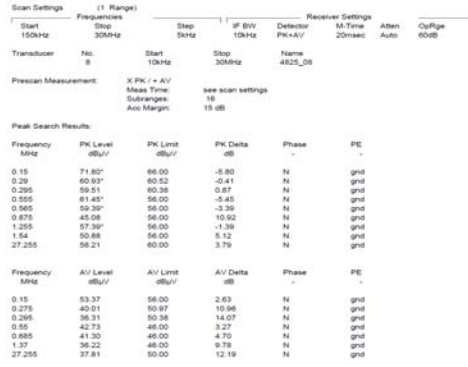

Radiated emission noise level (Pass, please zoom in to see the green mark)

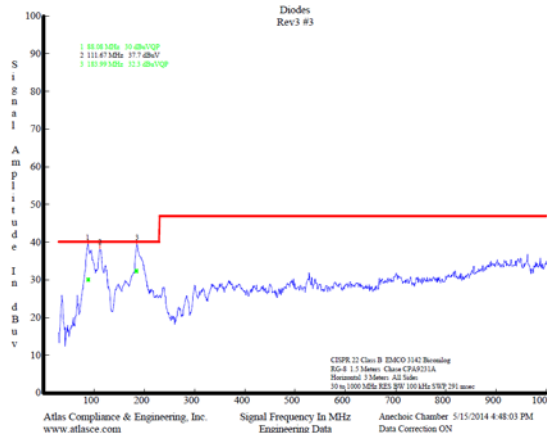
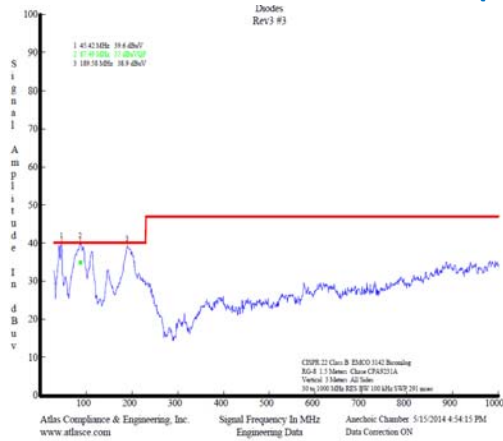

Note: Green color data are after VQP, will be 5db down than normal

IMPORTANT NOTICE

DIODES INCORPORATED MAKES NO WARRANTY OF ANY KIND, EXPRESS OR IMPLIED, WITH REGARDS TO THIS DOCUMENT, INCLUDING, BUT NOT LIMITED TO, THE IMPLIED WARRANTIES OF MERCHANTABILITY AND FITNESS FOR A PARTICULAR PURPOSE (AND THEIR EQUIVALENTS UNDER THE LAWS OF ANY JURISDICTION).

Diodes Incorporated and its subsidiaries reserve the right to make modifications, enhancements, improvements, corrections or other changes without further notice to this document and any product described herein. Diodes Incorporated does not assume any liability arising out of the application or use of this document or any product described herein; neither does Diodes Incorporated convey any license under its patent or trademark rights, nor the rights of others. Any Customer or user of this document or products described herein in such applications shall assume all risks of such use and will agree to hold Diodes Incorporated and all the companies whose products are represented on Diodes Incorporated website, harmless against all damages.

Diodes Incorporated does not warrant or accept any liability whatsoever in respect of any products purchased through unauthorized sales channel.

Should Customers purchase or use Diodes Incorporated products for any unintended or unauthorized application, Customers shall indemnify and hold Diodes Incorporated and its representatives harmless against all claims, damages, expenses, and attorney fees arising out of, directly or indirectly, any claim of personal injury or death associated with such unintended or unauthorized application.

Products described herein may be covered by one or more United States, international or foreign patents pending. Product names and markings noted herein may also be covered by one or more United States, international or foreign trademarks.

This document is written in English but may be translated into multiple languages for reference. Only the English version of this document is the final and determinative format released by Diodes Incorporated.

LIFE SUPPORT

Diodes Incorporated products are specifically not authorized for use as critical components in life support devices or systems without the express written approval of the Chief Executive Officer of Diodes Incorporated. As used herein:

A. Life support devices or systems are devices or systems which:

1. are intended to implant into the body, or
2. support or sustain life and whose failure to perform when properly used in accordance with instructions for use provided in the labeling can be reasonably expected to result in significant injury to the user.

B. A critical component is any component in a life support device or system whose failure to perform can be reasonably expected to cause the failure of the life support device or to affect its safety or effectiveness.

Customers represent that they have all necessary expertise in the safety and regulatory ramifications of their life support devices or systems, and acknowledge and agree that they are solely responsible for all legal, regulatory and safety-related requirements concerning their products and any use of Diodes Incorporated products in such safety-critical, life support devices or systems, notwithstanding any devices- or systems-related information or support that may be provided by Diodes Incorporated. Further, Customers must fully indemnify Diodes Incorporated and its representatives against any damages arising out of the use of Diodes Incorporated products in such safety-critical, life support devices or systems.

Copyright © 2015, Diodes Incorporated

www.diodes.com