

# IRF7607

HEXFET<sup>®</sup> Power MOSFET

- Trench Technology
- Ultra Low On-Resistance
- N-Channel MOSFET
- Very Small SOIC Package
- Low Profile (<1.1mm)
- Available in Tape & Reel

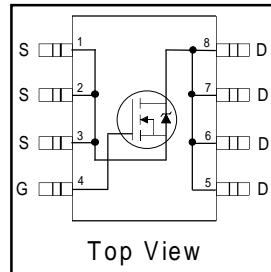

$V_{DSS} = 20V$
$R_{DS(on)} = 0.030\Omega$

## Description

New trench HEXFET<sup>®</sup> power MOSFETs from International Rectifier utilize advanced processing techniques to achieve extremely low on-resistance per silicon area. This benefit, combined with the ruggedized device design that HEXFET power MOSFETs are well known for, provides the designer with an extremely efficient and reliable device for use in a wide variety of applications.

The new Micro8<sup>™</sup> package has half the footprint area of the standard SO-8. This makes the Micro8 an ideal package for applications where printed circuit board space is at a premium. The low profile (<1.1 mm) of the Micro8 will allow it to fit easily into extremely thin application environments such as portable electronics and PCMCIA cards.

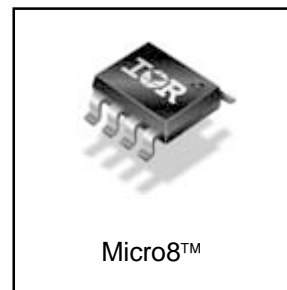

## Absolute Maximum Ratings

	Parameter	Max.	Units
$V_{DS}$	Drain- Source Voltage	20	V
$I_D @ T_A = 25^\circ C$	Continuous Drain Current, $V_{GS} @ 4.5V$	6.5	A
$I_D @ T_A = 70^\circ C$	Continuous Drain Current, $V_{GS} @ 4.5V$	5.2	
$I_{DM}$	Pulsed Drain Current ①	50	
$P_D @ T_A = 25^\circ C$	Power Dissipation	1.8	W
$P_D @ T_A = 70^\circ C$	Power Dissipation	1.2	
	Linear Derating Factor	0.014	W/°C
$V_{GS}$	Gate-to-Source Voltage	$\pm 12$	V
$T_J, T_{STG}$	Junction and Storage Temperature Range	-55 to + 150	°C

## Thermal Resistance

	Parameter	Max.	Units
$R_{\theta JA}$	Maximum Junction-to-Ambient③	70	°C/W

## Electrical Characteristics @ $T_J = 25^\circ\text{C}$ (unless otherwise specified)

	Parameter	Min.	Typ.	Max.	Units	Conditions
$V_{(BR)DSS}$	Drain-to-Source Breakdown Voltage	20	—	—	V	$V_{GS} = 0V, I_D = 250\mu A$
$\Delta V_{(BR)DSS}/\Delta T_J$	Breakdown Voltage Temp. Coefficient	—	0.016	—	V/ $^\circ\text{C}$	Reference to $25^\circ\text{C}, I_D = 1\text{mA}$
$R_{DS(on)}$	Static Drain-to-Source On-Resistance	—	—	0.030	$\Omega$	$V_{GS} = 4.5V, I_D = 6.5A$ ②
		—	—	0.045		$V_{GS} = 2.5V, I_D = 5.2A$ ②
$V_{GS(th)}$	Gate Threshold Voltage	0.60	—	1.2	V	$V_{DS} = V_{GS}, I_D = 250\mu A$
$g_{fs}$	Forward Transconductance	13	—	—	S	$V_{DS} = 10V, I_D = 6.5A$
$I_{DSS}$	Drain-to-Source Leakage Current	—	—	1.0	$\mu A$	$V_{DS} = 16V, V_{GS} = 0V$
		—	—	25		$V_{DS} = 16V, V_{GS} = 0V, T_J = 70^\circ\text{C}$
$I_{GSS}$	Gate-to-Source Forward Leakage	—	—	-100	nA	$V_{GS} = -12V$
	Gate-to-Source Reverse Leakage	—	—	100		$V_{GS} = 12V$
$Q_g$	Total Gate Charge	—	15	22	nC	$I_D = 6.5A$
$Q_{gs}$	Gate-to-Source Charge	—	2.2	3.3		$V_{DS} = 10V$
$Q_{gd}$	Gate-to-Drain ("Miller") Charge	—	3.5	5.3		$V_{GS} = 5.0V$ ②
$t_{d(on)}$	Turn-On Delay Time	—	8.5	—	ns	$V_{DD} = 10V$
$t_r$	Rise Time	—	11	—		$I_D = 1.0A$
$t_{d(off)}$	Turn-Off Delay Time	—	36	—		$R_G = 6.0\Omega$
$t_f$	Fall Time	—	16	—		$R_D = 10\Omega$ ②
$C_{iss}$	Input Capacitance	—	1310	—	pF	$V_{GS} = 0V$
$C_{oss}$	Output Capacitance	—	150	—		$V_{DS} = 15V$
$C_{rss}$	Reverse Transfer Capacitance	—	36	—		$f = 1.0\text{MHz}$

## Source-Drain Ratings and Characteristics

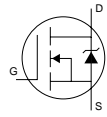
	Parameter	Min.	Typ.	Max.	Units	Conditions
$I_S$	Continuous Source Current (Body Diode)	—	—	1.8	A	MOSFET symbol showing the integral reverse p-n junction diode. 
$I_{SM}$	Pulsed Source Current (Body Diode) ①	—	—	50		
$V_{SD}$	Diode Forward Voltage	—	—	1.2	V	$T_J = 25^\circ\text{C}, I_S = 1.7A, V_{GS} = 0V$ ②
$t_{rr}$	Reverse Recovery Time	—	19	29	ns	$T_J = 25^\circ\text{C}, I_F = 1.7A$
$Q_{rr}$	Reverse Recovery Charge	—	13	20	nC	$di/dt = 100A/\mu s$ ②

### Notes:

① Repetitive rating; pulse width limited by max. junction temperature. (See fig. 11)

② Pulse width  $\leq 400\mu s$ ; duty cycle  $\leq 2\%$ .

③ Surface mounted on FR-4 board,  $t \leq 5\text{sec}$ .

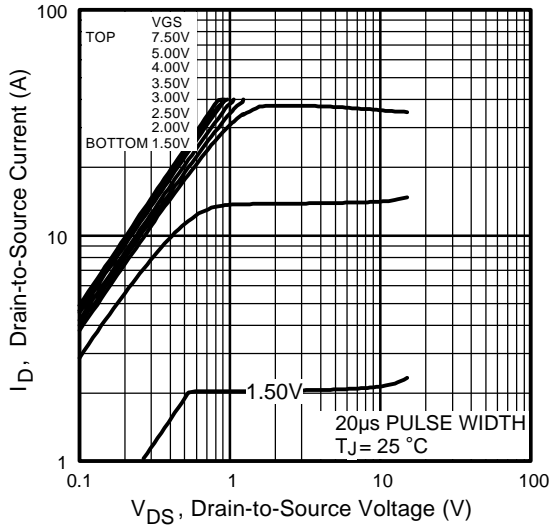

Fig 1. Typical Output Characteristics

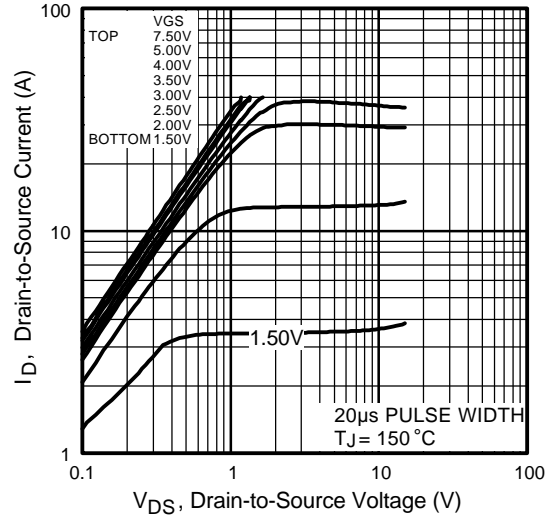

Fig 2. Typical Output Characteristics

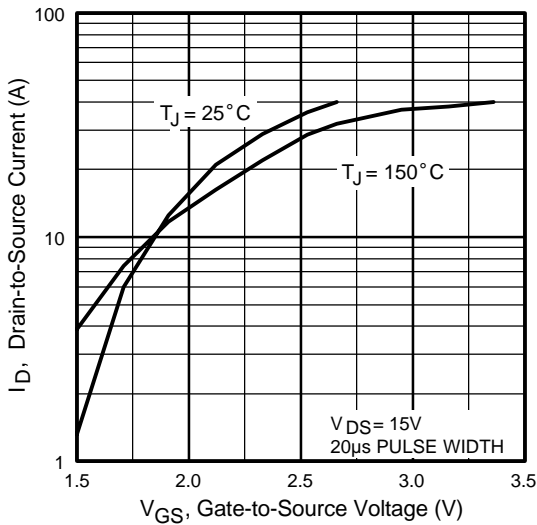

Fig 3. Typical Transfer Characteristics

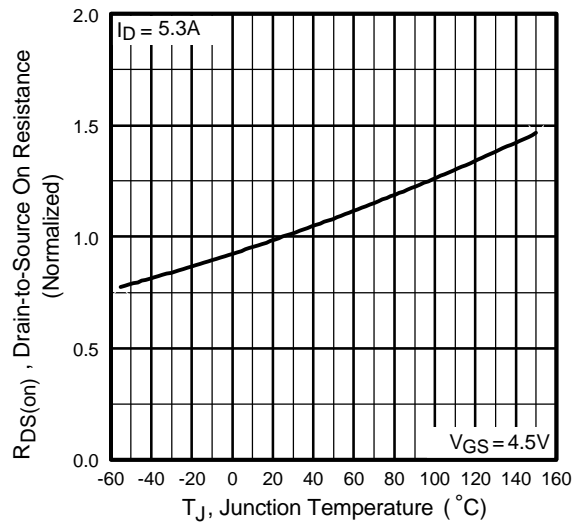
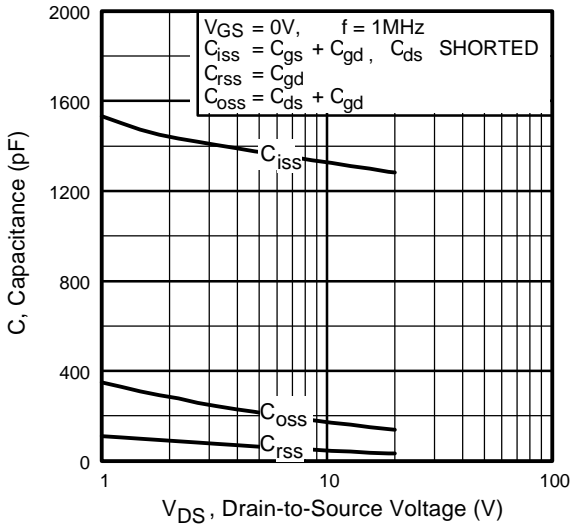
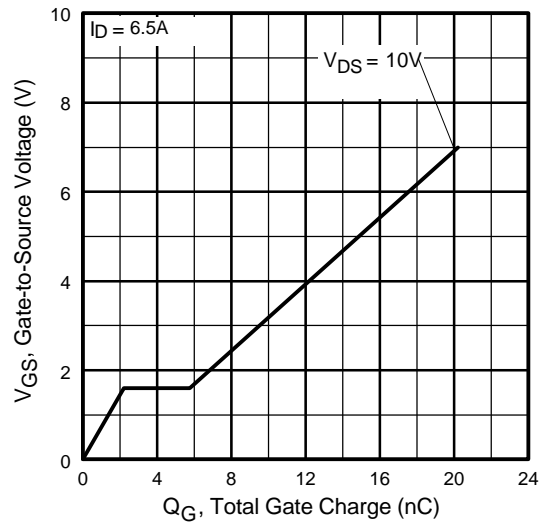

Fig 4. Normalized On-Resistance Vs. Temperature



**Fig 5.** Typical Capacitance Vs. Drain-to-Source Voltage



**Fig 6.** Typical Gate Charge Vs. Gate-to-Source Voltage

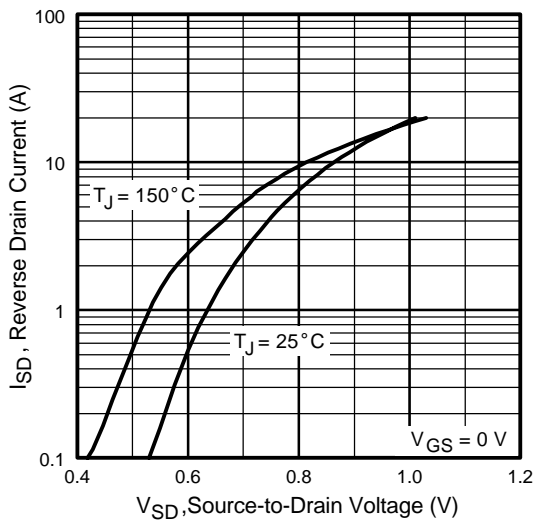

**Fig 7.** Typical Source-Drain Diode Forward Voltage

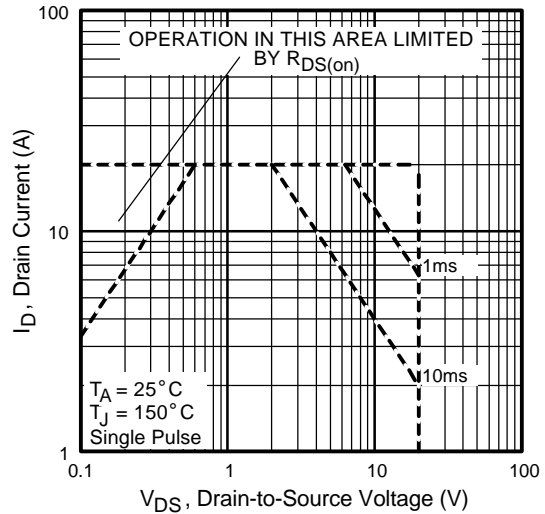

**Fig 8.** Maximum Safe Operating Area

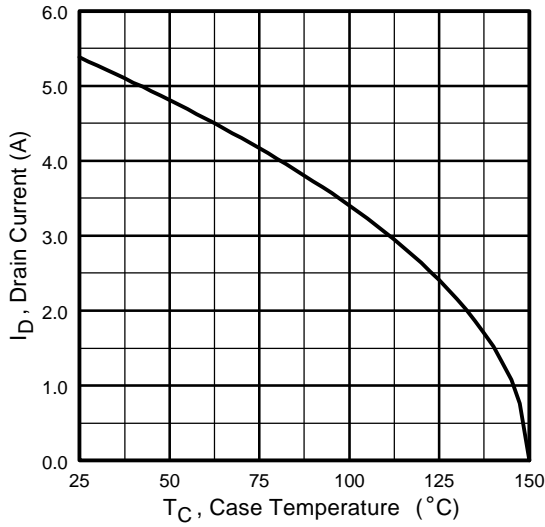

**Fig 9.** Maximum Drain Current Vs. Case Temperature

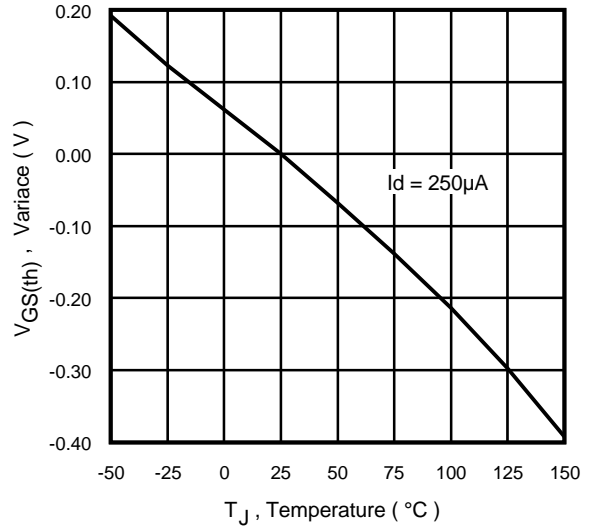

**Fig 10.** Typical  $V_{GS(th)}$  Variance Vs. Junction Temperature

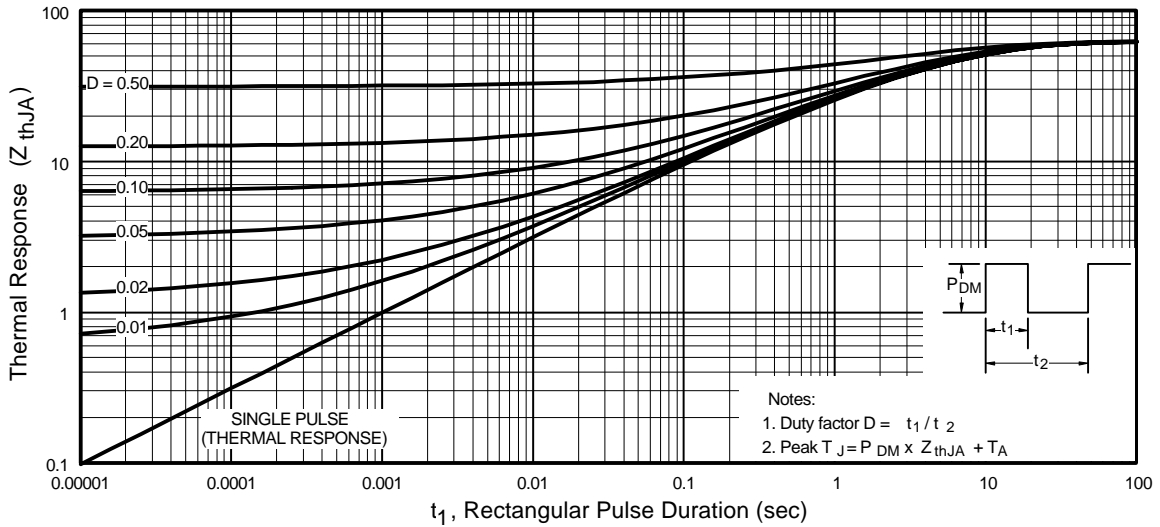

**Fig 11.** Maximum Effective Transient Thermal Impedance, Junction-to-Ambient

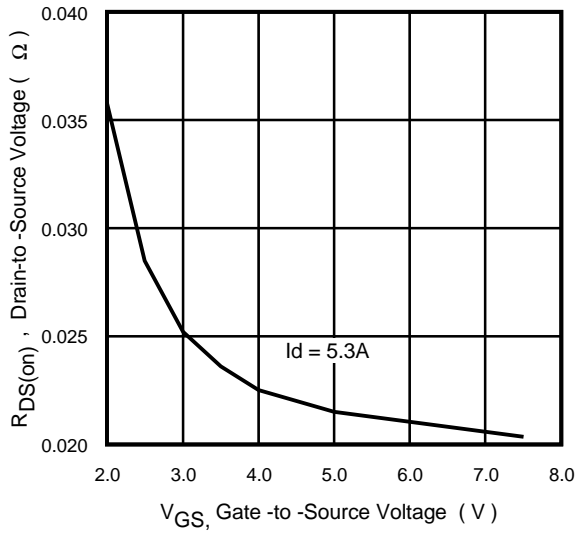

**Fig 12.** Typical On-Resistance Vs. Gate Voltage

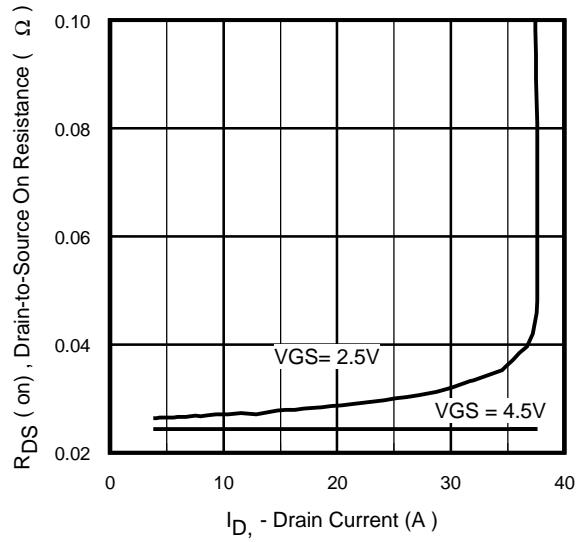

**Fig 13.** Typical On-Resistance Vs. Drain Current

## Micro8™ Package Outline

Dimensions are shown in millimeters (inches)

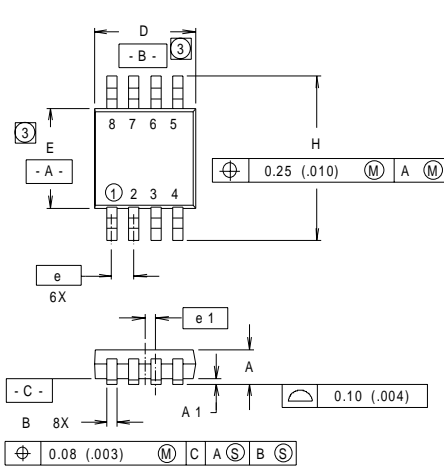

### LEAD ASSIGNMENTS

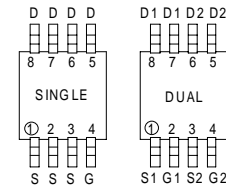

DIM	INCHES		MILLIMETERS	
	MIN	MAX	MIN	MAX
A	.036	.044	0.91	1.11
A1	.004	.008	0.10	0.20
B	.010	.014	0.25	0.36
C	.005	.007	0.13	0.18
D	.116	.120	2.95	3.05
e	.0256 BASIC		0.65 BASIC	
e1	.0128 BASIC		0.33 BASIC	
E	.116	.120	2.95	3.05
H	.188	.198	4.78	5.03
L	.016	.026	0.41	0.66
θ	0°	6°	0°	6°

### RECOMMENDED FOOTPRINT

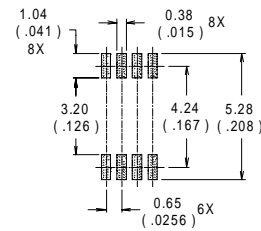

#### NOTES:

- 1 DIMENSIONING AND TOLERANCING PER ANSI Y14.5M-1982.
- 2 CONTROLLING DIMENSION : INCH.
- 3 DIMENSIONS DO NOT INCLUDE MOLD FLASH.

## Micro8™ Part Marking Information

EXAMPLE: THIS IS AN IRF 7501

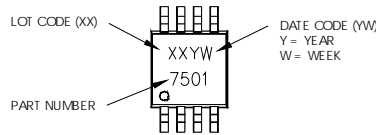

WW = (1-26) IF PRECEDED BY LAST DIGIT OF CALENDAR YEAR

DATE CODE EXAMPLES:  
 YWW = 9503 = 5C  
 YWW = 9532 = EF

YEAR	Y	WORK WEEK	W
2001	1	01	A
2002	2	02	B
2003	3	03	C
1994	4	04	D
1995	5		
1996	6		
1997	7		
1998	8		
1999	9		
2000	0	24	X
		25	Y
		26	Z

WW = (27-52) IF PRECEDED BY A LETTER

YEAR	Y	WORK WEEK	W
2001	A	27	A
2002	B	28	B
2003	C	29	C
1994	D	30	D
1995	E		
1996	F		
1997	G		
1998	H		
1999	J		
2000	K	50	X
		51	Y
		52	Z

# IRF7607

International  
**IR** Rectifier

## Micro8™ Tape & Reel Information

Dimensions are shown in millimeters (inches)

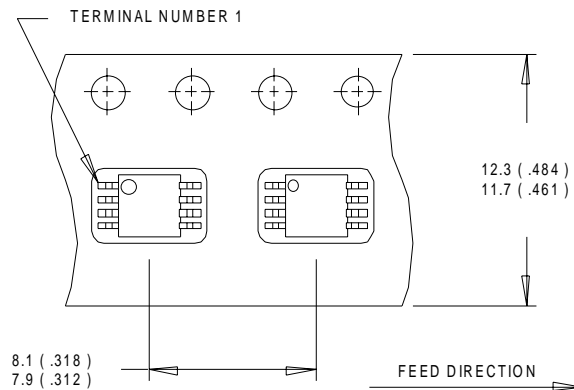

NOTES:

1. OUTLINE CONFORMS TO EIA-481 & EIA-541.
2. CONTROLLING DIMENSION : MILLIMETER.

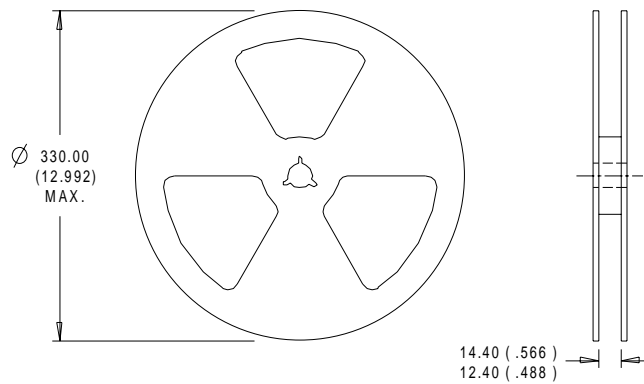

NOTES:

1. CONTROLLING DIMENSION : MILLIMETER.
2. OUTLINE CONFORMS TO EIA-481 & EIA-541.

This product has been designed and qualified for the consumer market.  
Qualification Standards can be found on IR's Web site.

International  
**IR** Rectifier

**IR WORLD HEADQUARTERS:** 233 Kansas St., El Segundo, California 90245, USA Tel: (310) 252-7105  
TAC Fax: (310) 252-7903

Visit us at [www.irf.com](http://www.irf.com) for sales contact information.

*Data and specifications subject to change without notice. 02/01*

[www.irf.com](http://www.irf.com)