

PROJECT NO. SD-35897-008  
 SIMILAR ITEM  
 PROJECT NO.  
 DO NOT SCALE DRAWING DIMENSION IN METRIC

1	35897-2095	.040/090 M/HSG 20P	POLYESTER	WHITE
2	35897-2083	.040/090 MALE TPA 20P	POLYESTER	YELLOW

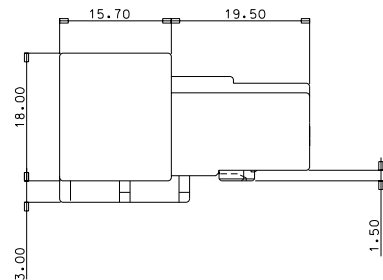

SECTION A-A

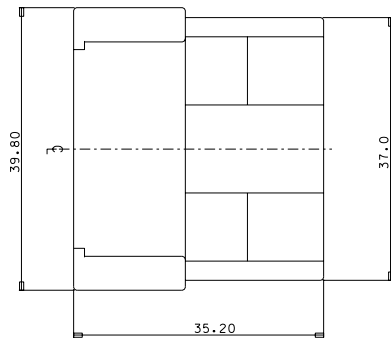
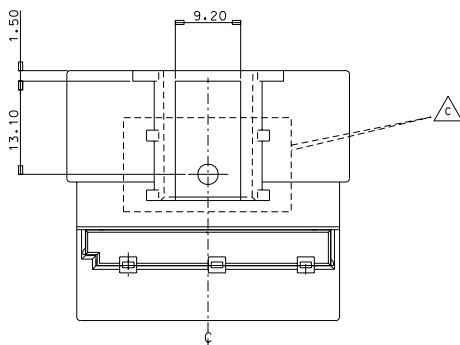
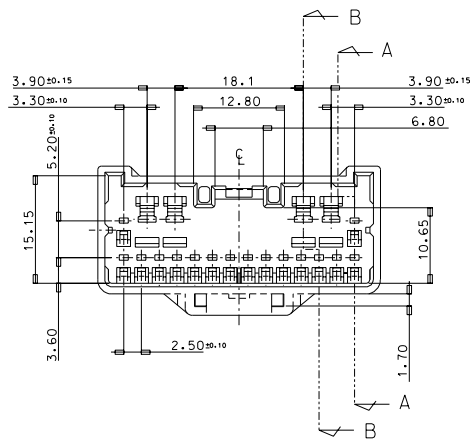
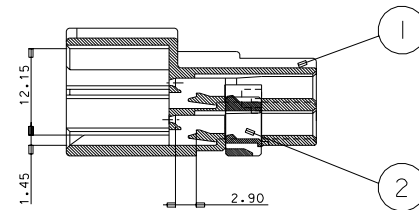

SECTION B-B

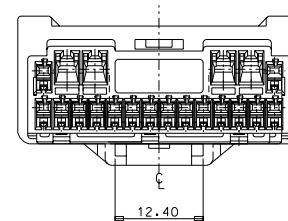
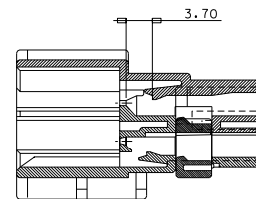

1. MATERIAL & FINISH: SEE TABLE
2. APPLICATION: .040/090 FEMALE HOUSING ASS'Y 22P(ENG. NO.:35896-2010)

RELEASE TO MANUFACTURING <b>EC NO.:</b> KOP2003-0086 <b>DRWN:</b> H.C.RHO 02/09/20 <b>CHK:</b> H.C.RHO 02/10/17 <b>APPR:</b> C.W.LEE 02/10/18		<b>QUALITY SYMBOLS</b> MAJOR CRITICAL	GENERAL TOLERANCES: (UNLESS SPECIFIED) 4 PLACES ±0.15 3 PLACES ±0.2 2 PLACES ±0.3 1 PLACE ±0.3	SCALE 2:1 DESIGN UNITS <input checked="" type="checkbox"/> mm <input type="checkbox"/> INCH DRAWN BY & DATE 00/09/30 H.C.RHO CHECKED BY & DATE 00/09/30 B.K.CHOI APPROVED BY & DATE 00/09/30 C.W.LEE	THIRD ANGLE PROJECTION TITLE: .040/090 MALE HOUSING ASS'Y 20P	DIMENSIONS: <input type="checkbox"/> INCH <input checked="" type="checkbox"/> mm <input type="checkbox"/> INCH <input checked="" type="checkbox"/> mm ONLY	SHT 1 OF 1 REV REVISIONS CAD ONLY
CAD FILENAME 49MHA20	MATERIAL NO. SEE CHART	DRAWING NO. SD-35897-008	SHEET NO. 1 OF 1	SIZE C	THIS DRAWING CONTAINS INFORMATION THAT IS PROPRIETARY TO MOLEX INCORPORATED AND SHOULD NOT BE USED WITHOUT WRITTEN PERMISSION.	MOLEX INCORPORATED	