

# Saturating Chokes

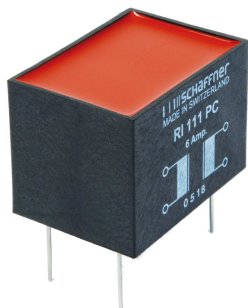

- Rated currents from 1.5 to 25 A

---

- Up to 500 VAC operating voltage

---

- DC to 1 kHz frequency

---

- Single or dual-choke configurations

---



### Performance indicators

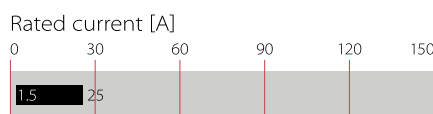

## Technical specifications

<b>Maximum continuous operating voltage</b>	500 VAC @ 40°C
<b>Rated currents</b>	1.5 to 25 A @ 40°C max.
<b>High potential test voltage winding-to-winding @ 25°C and/or winding-to-inserts</b>	2500 VAC, 60 sec, guaranteed
<b>Surge current @ 10 msec</b>	20 x I <sub>N</sub> @ 25°C
<b>Temperature range (operation and storage)</b>	-25°C to +110°C (25/110/21)
<b>Flammability corresponding to</b>	UL 94 V-0
<b>MTBF @ 40°C/230 V (Mil-HB-217F)</b>	>5,000,000 hours

### Approvals

## ROHS

RI saturating type chokes change impedance at the moment of switching, and can be used to attenuate differential-mode noise or symmetrical interference as generated in fast switching high current applications. These chokes are typically used in conjunction with suppression capacitors. For optimum attenuation chokes must be connected as close as possible to the semiconductor switching device.

## Features and benefits

- Excellent thermal behavior

---

- Through hole or wire connections

---

- Single or dual-choke configurations

---

- Up to 25 A single configuration

---

- Custom-specific versions are available on request

---

## Typical applications

- Suppressing high interference levels generated by fast switching circuits

---

- DC voltage smoothing

---

- EMC/EMI filters

---

- Phase angle control circuits

---

- Power supplies

---

- Chargers

---

### Typical electrical schematic



## Choke selection table

Choke	Nominal current @ 40°C	Resistance R	Choke configuration	Input/Output connections		Weight
				[A]	[mΩ/path]	
RI 111 PC	6	42	2	02		170
RI 401 PC	1.5	620	1	02		15
RI 403 PC	3	105	1	02		30
RI 406 PC	6	53	1	02		55
RI 410 PC	10	28	1	02		95
RI 415	15	8	1		07	205
RI 425	25	4	1		07	325

Test conditions:

Resistance tolerance: ±15% @ 25°C

Electrical characteristics @ 25°C: ±2°C

## Typical saturation characteristics

Inductance (typical value in %) vs. nominal current in %

RI series

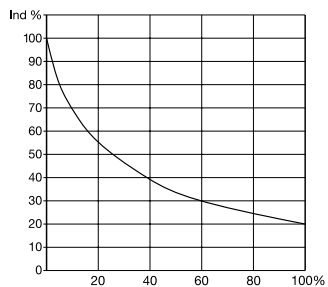

## Mechanical data

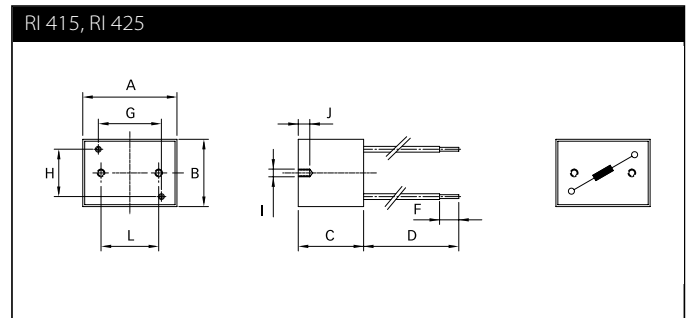
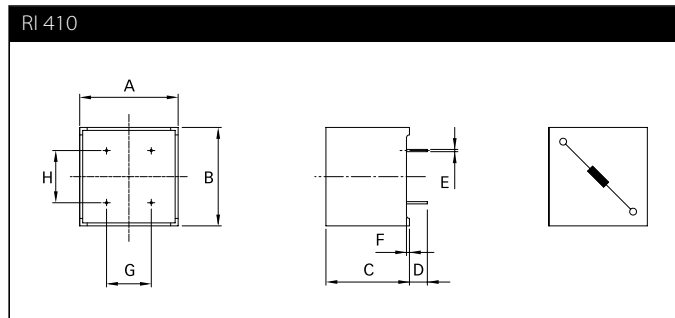
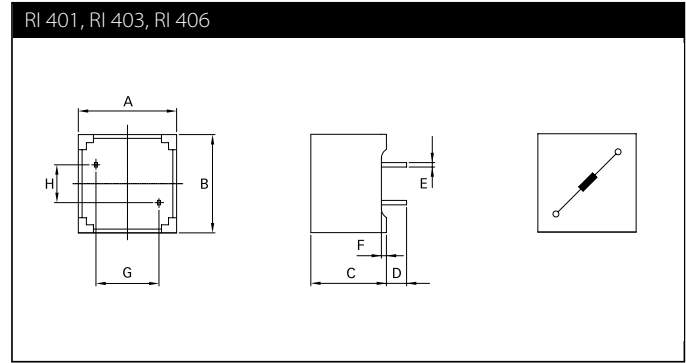
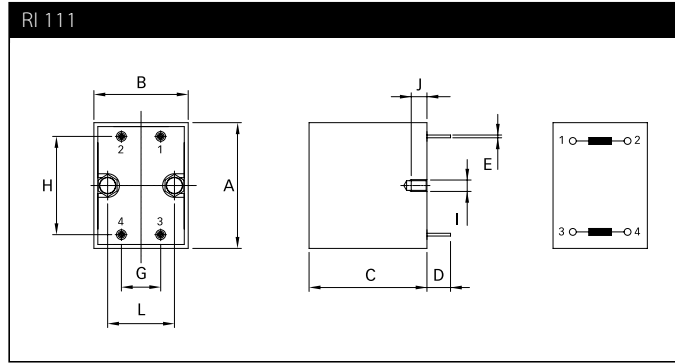

## Dimensions

	<b>RI 111</b>	<b>RI 401</b>	<b>RI 403</b>	<b>RI 406</b>	<b>RI 410</b>	<b>RI 415</b>	<b>RI 425</b>	<b>Tolerances</b>
<b>A</b>	49	19.5	23.3	28.5	33	35	48	
<b>B</b>	35	19.5	23.3	28.5	33	49	48	
<b>C</b>	34	15	18	21.5	28	34	43	±0.3
<b>D</b>	15	4 ±0.5	6 ±0.5	4.5 ±0.5	6 ±0.5	200	200	
<b>E</b>	∅1.15	0.6 x 0.88	∅0.9	0.6 x 0.88	0.75 x 1.1			±0.1
<b>F</b>		1			1	10	10	
<b>G</b>	20	12.5	15	20	17.5	22	39	
<b>H</b>	40	7.5	10	10	15	36	35	
<b>I</b>	M4					M4	M4	
<b>J</b>	6					6	6	+0/-0.5
<b>L</b>	21					30	30	±0.25

All dimensions in mm; 1 inch = 25.4 mm  
Tolerances according: ISO 2768-m/EN 22768-m

Please visit [www.schaffner.com](http://www.schaffner.com) to find more details on filter connections.



## Headquarters, global innovation and development

### Switzerland

#### Schaffner Group

Nordstrasse 11  
4542 Luterbach  
T +41 32 681 66 26  
[info@schaffner.com](mailto:info@schaffner.com)  
[www.schaffner.com](http://www.schaffner.com)



## Sales and application centers

### China

#### Schaffner EMC Ltd. Shanghai

T20-3 C, No 565 Chuangye Road,  
Pudong district  
201201 Shanghai  
T +86 21 3813 9500  
[cschina@schaffner.com](mailto:cschina@schaffner.com)  
[www.schaffner.com.cn](http://www.schaffner.com.cn)

### Finland

#### Schaffner Oy

Sauvonrinne 19 H  
08500 Lohja  
T +358 50 468 7284  
[finlandsales@schaffner.com](mailto:finlandsales@schaffner.com)

### France

#### Schaffner EMC S.A.S.

16-20 Rue Louis Rameau  
95875 Bezons  
T +33 1 34 34 30 60  
F +33 1 39 47 02 28  
[francesales@schaffner.com](mailto:francesales@schaffner.com)

### Germany

#### Schaffner Deutschland GmbH

Schoemperlenstrasse 12B  
76185 Karlsruhe  
T +49 721 56910  
F +49 721 569110  
[germanysales@schaffner.com](mailto:germanysales@schaffner.com)

### India

#### Schaffner India Pvt. Ltd

Unit 59, Level, Mfar Greenheart 7  
Manyata Tech Park, Hebbal Outer Ring Road  
560045 Bangalore  
T +91 80 6781 9805  
F +91 80 6781 9998  
[indiasales@schaffner.com](mailto:indiasales@schaffner.com)

### Italy

#### Schaffner EMC S.r.l.

Via Ticino, 30  
20900 Monza (MB)  
T +39 039 21 41 070  
[italysales@schaffner.com](mailto:italysales@schaffner.com)

### Japan

#### Schaffner EMC K.K.

1-32-12, Kamiyama, Setagaya-ku  
7F Mitsui-seimei Sengenjaya Bldg.  
154-0011 Tokyo  
T +81 3 5712 3650  
F +81 3 5712 3651  
[japansales@schaffner.com](mailto:japansales@schaffner.com)  
[www.schaffner.jp](http://www.schaffner.jp)

### Singapore

#### Schaffner EMC Pte Ltd.

#05-09, Kg Ubi Ind. Estate  
408705 Singapore  
T +65 6377 3283  
F +65 6377 3281  
[singaporesales@schaffner.com](mailto:singaporesales@schaffner.com)

### Spain

#### Schaffner EMC España

Calle Caléndula 93, Miniparc III, Edificio E  
El Soto de Moraleja, Alcobendas  
28109 Madrid  
T +34 917 912 900  
F +34 917 912 901  
[spainsales@schaffner.com](mailto:spainsales@schaffner.com)

### Sweden

#### Schaffner EMC AB

Tegeluddsvägen 76, 2tr  
115 28 Stockholm  
T +46 8 5050 2425  
[swedensales@schaffner.com](mailto:swedensales@schaffner.com)  
[www.schaffner.com](http://www.schaffner.com)

### Switzerland

#### Schaffner EMV AG

Nordstrasse 11  
4542 Luterbach  
T +41 32 681 66 88  
[switzerlandsales@schaffner.com](mailto:switzerlandsales@schaffner.com)

### Taiwan R.O.C.

#### Schaffner EMV Ltd.

20 Floor-2, No 97, Section 1, XinTai 5th Road  
22175 XiZhi District New Taipei City 22175  
T +886 2 2697 5500  
F +886 2 2697 5533  
[taiwansales@schaffner.com](mailto:taiwansales@schaffner.com)  
[www.schaffner.com.tw](http://www.schaffner.com.tw)

### Thailand

#### Schaffner EMC Co. Ltd.

Northern Region Industrial Estate  
67 Moo 4 Tambon Ban Klang  
Amphur Muangng P.O. Box 14  
51000 Lamphun  
T +66 53 58 11 04  
F +66 53 58 10 19  
[thailandsales@schaffner.com](mailto:thailandsales@schaffner.com)

### United Kingdom

#### Schaffner Ltd.

5 Ashville Way, Molly Millars Lane  
Wokingham  
RG41 2PL Berkshire  
T +44 118 9770070  
F +44 118 9792969  
[uksales@schaffner.com](mailto:uksales@schaffner.com)

### USA

#### Schaffner EMC Inc.

52 Mayfield Avenue  
08837 Edison, New Jersey  
T +1 800 367 5566  
T +1 732 225 9533  
F +1 732 225 4789  
[usasales@schaffner.com](mailto:usasales@schaffner.com)  
[www.schaffnerusa.com](http://www.schaffnerusa.com)

#### Schaffner North America

6722 Thirlane Road  
24019 Roanoke, Virginia  
T +1 276 228 7943  
F +1 276 228 7953

#### Schaffner North America

823 Fairview Road  
24382 Wytheville, Virginia  
T +1 276 228 7943  
F +1 276 228 7258

To find your local partner within Schaffner's global network: [www.schaffner.com](http://www.schaffner.com)

© 2018 Schaffner Group

The content of this document has been carefully checked and understood. However, neither Schaffner nor its subsidiaries assume any liability whatsoever for any errors or inaccuracies of this document and the consequences thereof. Published specifications are subject to change without notice. Product suitability for any area of application must ultimately be determined by the customer. In all cases, products must never be operated outside their published specifications. Schaffner does not guarantee the availability of all published products. This disclaimer shall be governed by substantive Swiss law and resulting disputes shall be settled by the courts at the place of business of Schaffner Holding AG. Latest publications and a complete disclaimer can be downloaded from the Schaffner website. All trademarks recognized.