

## General Description

The MAX11300 evaluation kit (EV kit) provides a proven design to evaluate the MAX11300 20-port programmable mixed-signal I/O with 12-bit ADC, 12-bit DAC, analog switches, and GPIO. The EV kit also includes Windows XP®, Windows Vista®, Windows® 7-, and Windows 8.0-/8.1-compatible software that provides a simple graphical user interface (GUI) for exercising the features of the IC.

The EV kit comes with a MAX11300GTL+ installed.

## Features and Benefits

- 20 PIXI™ Ports for Analog or Digital Control or Sensing
- Two External Temperature Sensors (2N3904)
- 50-Pin Signal Header (20 Ports, Two Temperatures, and Power Supplies)
- SPI Interface Terminals
- Optional 2.5V On-Board Reference (MAX6071)
- Windows XP-, Windows Vista-, Windows 7-, and Windows 8.0-/8.1-Compatible Software
- USB-PC Connection (Cable Included)
- RoHS Compliant
- Proven Four-Layer PCB Layout
- Fully Assembled and Tested

**Ordering Information** appears at end of data sheet.

*Windows, Windows XP, and Windows Vista are registered trademarks and registered service marks of Microsoft Corporation.*

*PIXI is a trademark of Maxim Integrated Products, Inc.*

**Note:** Active-low pin names such as  $\overline{INT}$  are shown in the software and PCB layout with a B suffix (e.g., INTB).

## Quick Start

### Required Equipment

- EV kit (USB mini-B cable included)
- Windows XP, Windows Vista, Windows 7, Windows 8.0, or Windows 8.1 PC, running .NET v4, with a spare USB port
- $\pm 12.5\text{V}$  DC at 500mA dual-output DC power supply
- Digital voltmeter (DVM)

**Note:** In the following sections, software-related items are identified by bolding. Text in **bold** refers to items directly from the EV kit software. Text in **bold and underlined** refers to items from the Windows operating system.

### Procedure

The EV kit is fully assembled and tested. Follow the steps below to verify board operation:

- 1) Visit [www.maximintegrated.com/evkitsoftware](http://www.maximintegrated.com/evkitsoftware) to download the latest version of the EV kit software, MAX11300EVKitSetupV1.1.zip. Save the EV kit software to a temporary folder and uncompress the ZIP file.
- 2) Install the EV kit software and USB driver on your computer by running the MAX11300EVKitSetupV1.0.exe program inside the temporary folder. The program files are copied to your PC and icons are created in the Windows **Start | Programs** menu. During software installation, some versions of Windows may show a warning message indicating that this software is from an unknown publisher. This is not an error condition and it is safe to proceed with installation. Administrator privileges are required to install the USB device driver on Windows. **Note:** The software requires .NET Framework v4. If this framework is not detected during installation, the installer launches dotNetFx40\_Full\_setup.exe to install it. Internet access may be required to install the .NET Framework v4 if it is not already installed.
- 3) Verify that all jumpers are in their default positions, as shown in [Table 1](#), [Table 2](#), [Table 3](#), and [Table 4](#).
- 4) Configure the power supply for  $\pm 12.5\text{V}$  DC output (typical load current is 50mA) (be sure to keep AVD-DIO-AVSSIO within rated supply range).

- 5) Connect the +12.5V DC power supply between AVDDIO (+) and GND (-). Connect the -12.5V DC power supply between AVSSIO (-) and GND (+).
- 6) Connect the DVM- to GND (-)
- 7) Enable the power-supply output.
- 8) Connect the USB cable from the PC to the EV kit board. A Windows message appears when connecting the EV kit board to the PC for the first time. Each version of Windows has a slightly different message. If you see a Windows message stating **Ready to Use**, proceed to the next step. Otherwise, open the USB\_Driver\_Help\_200.PDF document in the Windows **Start | Programs** menu to verify that the USB driver was installed successfully.
- 9) Use the DVM+ to verify the test point voltages shown in [Table 2](#).
- 10) Start the MAX11300 Configuration Software by opening its icon in the Windows **Start | Programs** menu.

The MAX11300 configuration software main window appears, as shown in [Figure 1](#). Drag and drop components into the device, wire them up, and then use the **File** menu | **Generate Registers** to export the configuration to Max11300Register.csv.

- 11) Start the EV kit software by opening its icon in the Windows **Start | Programs** menu. The EV kit software main window appears, as shown in [Figure 2](#).
- 12) Select **File** menu | **Load Configuration...** | **MAX11300Register.csv** to load the configuration into the MAX11300. Alternatively, use one of the prebuilt demo configurations, such as MAX11300Register\_20131115\_1505.csv, which configures all 20 PIXI ports with different configurations.
- 13) Select the **Chart** tab, then check **Options** menu | **Polling** to show the analog inputs on a graph. Select the **Data** tab to see the low-level input code values in hexadecimal.

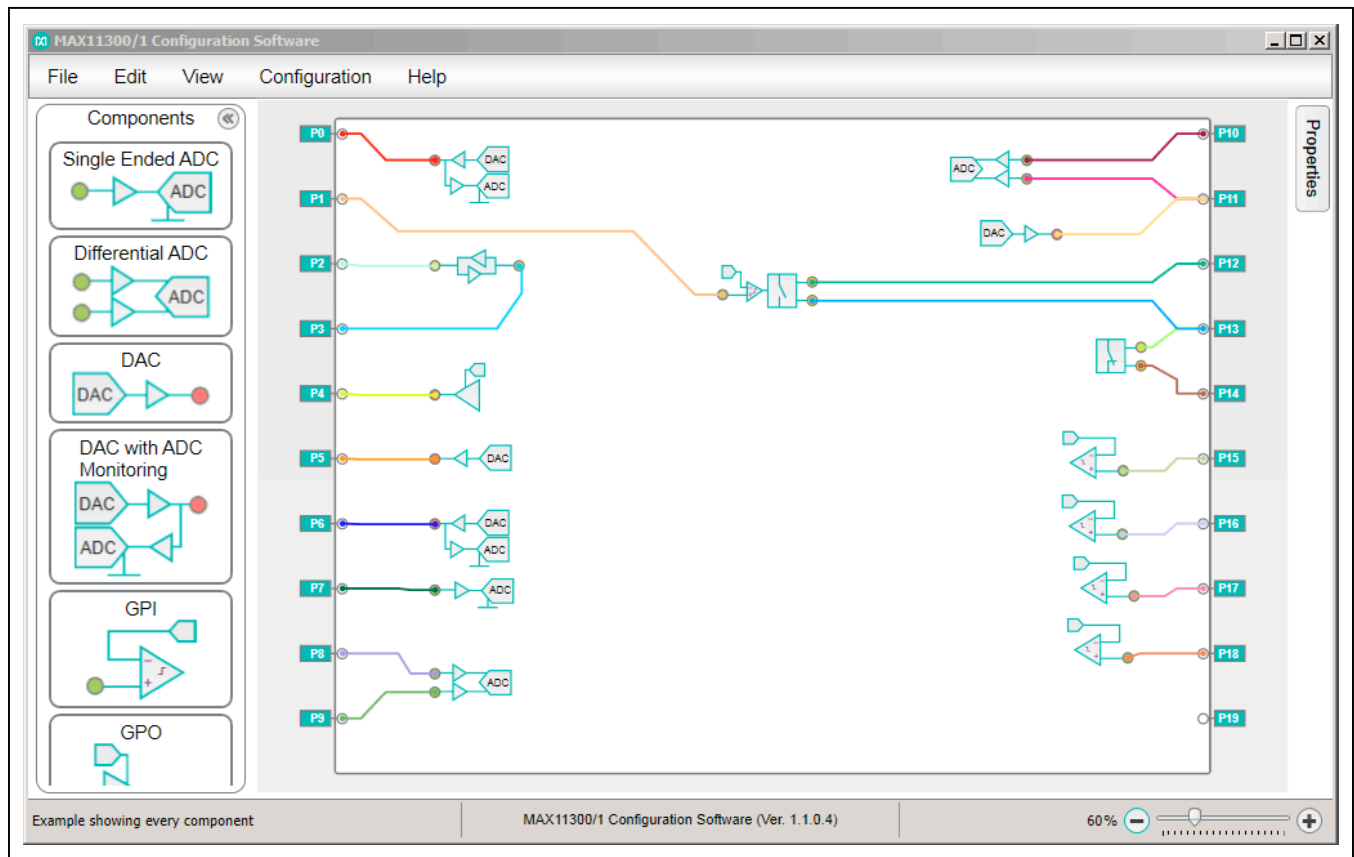

Figure 1. MAX11300 EV Kit Configuration Software

### Detailed Description of EV Kit Software

The **Device Configuration** tab (Figure 2) accesses the global device control registers, interrupt sources,

temperature limits, DAC presets, and ADC conversion rate. Changing the controls on the GUI writes the corresponding registers immediately.

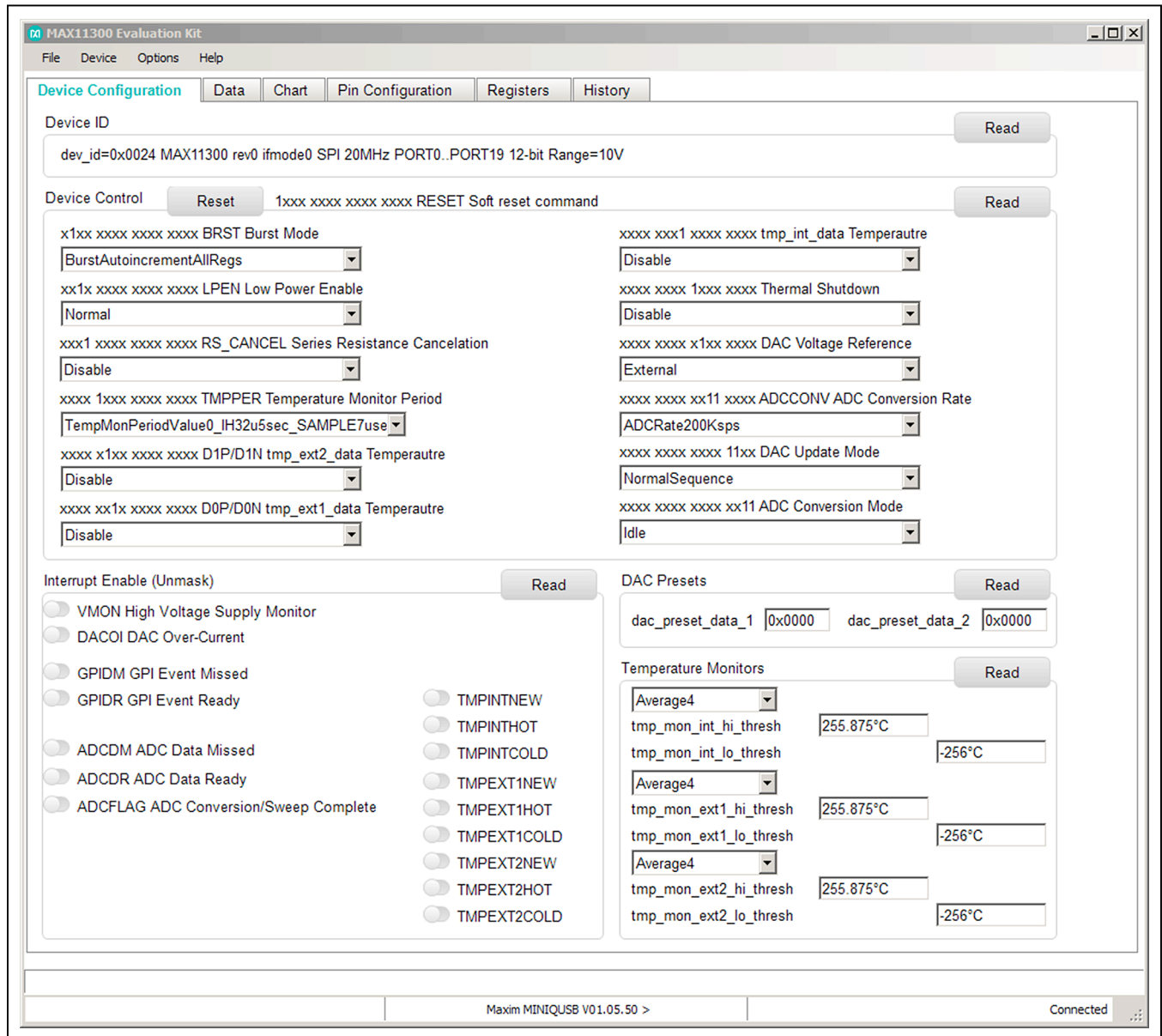

Figure 2. Device Configuration Tab

Port	Configured As	DAC Out	GPO Out	Write	Input	Interrupt	Description
PORT0	0x6100 DACoutWithADCmonitor	0x0000		Write	0x0000		[ADC New]
PORT1	0x1000 GPIOinPgmThreshold	0x0666		Write	0	0 masked	[gpi_status=0]
PORT2	0x2000 GPIOinOutBidirLevelTrans			Write			
PORT3	0x0000 HighImpedance			Write			
PORT4	0x3000 GPIOoutRegDrivenOutputDAClevel	0x0666	0	Write			
PORT5	0x5100 DACout	0x0000		Write			
PORT6	0x6100 DACoutWithADCmonitor	0x0000		Write	0x0000		[ADC New]
PORT7	0x7400 ADCinPosSingleEnded			Write	0x0096		[ADC New]
PORT8	0x8409 ADCinPosDifferential			Write	0x0006		[ADC New][PORT9]
PORT9	0x9400 ADCinNegDifferential			Write			
PORT10	0x810b ADCinPosDifferential			Write	0x006d		[ADC New][PORT11]
PORT11	0xa100 DACoutADCinNegDifferential	0x0000		Write			
PORT12	0xb001 GPIOBidirAnalogSwitchExtControlled			Write			[PORT1]
PORT13	0xc000 GPIOBidirAnalogSwitch			Write			
PORT14	0x0000 HighImpedance			Write			
PORT15	0x1000 GPIOinPgmThreshold	0x0666		Write	1	0 masked	[gpi_status=0]
PORT16	0x1000 GPIOinPgmThreshold	0x0666		Write	0	1 pos edge	[gpi_status=0]
PORT17	0x1000 GPIOinPgmThreshold	0x0666		Write	0	2 neg edge	[gpi_status=0]
PORT18	0x1000 GPIOinPgmThreshold	0x0666		Write	0	3 any edge	[gpi_status=0]
PORT19	0x0000 HighImpedance			Write			
INT	Internal Temperature				0x00df		27.875°C
EXT1	External Temperature D0P/D0N				0x00e9		29.125°C
EXT2	External Temperature D1P/D1N				0x00ea		29.25°C

Figure 3. Data Tab



The **Data** tab (Figure 3) presents a tabular display of all PIXI ports and temperature channels. Double-click in the **Configured As** cells to jump directly to the **Pin Configuration** tab (Figure 5) for the corresponding pin. Each row represents one of the PIXI ports or one of the temperature sensors. Some configurations enable **DAC**

**Out** or **GPO Out** controls, or provide ADC or GPI input values. Pins configured for GPI input can be used as interrupt sources by double-clicking in the Interrupt cell. Select the **Chart** tab (Figure 4), then check **Options** menu | **Polling** to show the analog inputs on a graph.

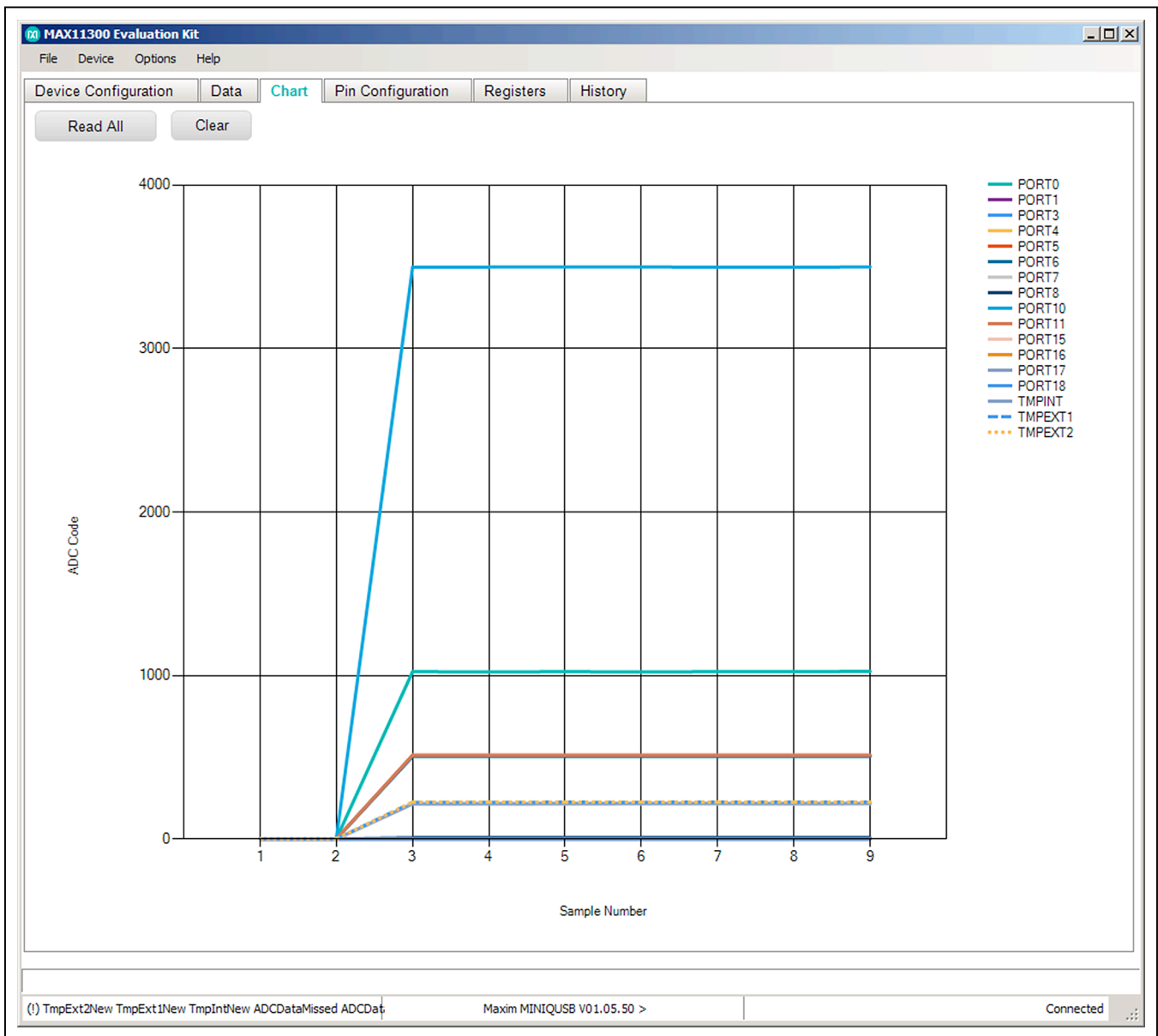

Figure 4. Chart Tab

The PIXI ports can be viewed and manually adjusted from the **Pin Configuration** tab. Selecting the pin function affects the choices in the other four fields. The software does not attempt to validate the configuration.

The normal development flow is to start in the MAX11300 Configuration software, use its **Generate Registers** menu item to export the registers to a \*.csv file, then use the EV kit software to connect to the hardware and load that \*.csv file.

The GPIO1–GPIO3 pins are spare outputs from the MAXQ2000 microcontroller that can be optionally used to support external diagnostic testing. They are not part of the MAX11300.

The supply voltages are used to help validate the available operating ranges, but the software has no way to independently verify that the nominal values are actually present.

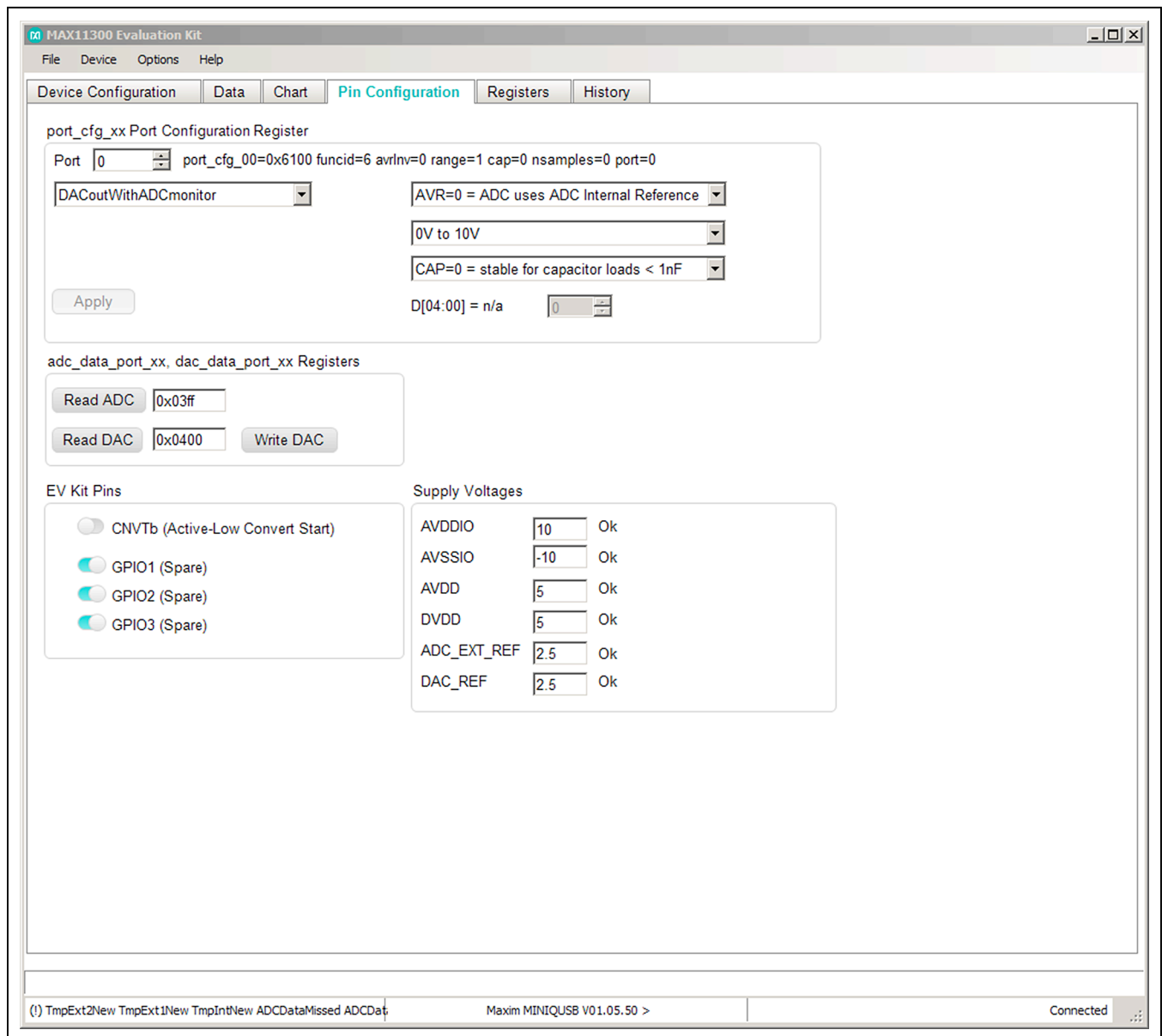

Figure 5. Pin Configuration Tab

The **Registers** tab (Figure 6) provides a tabular display of all registers of the device, supporting low-level read and write operations in hexadecimal. Write is effective by the

**Write** button. Refer to the MAX11300 IC data sheet for the meaning and format of the various registers.

The **History** tab provides a diagnostic log of the commands sent to the EV kit.

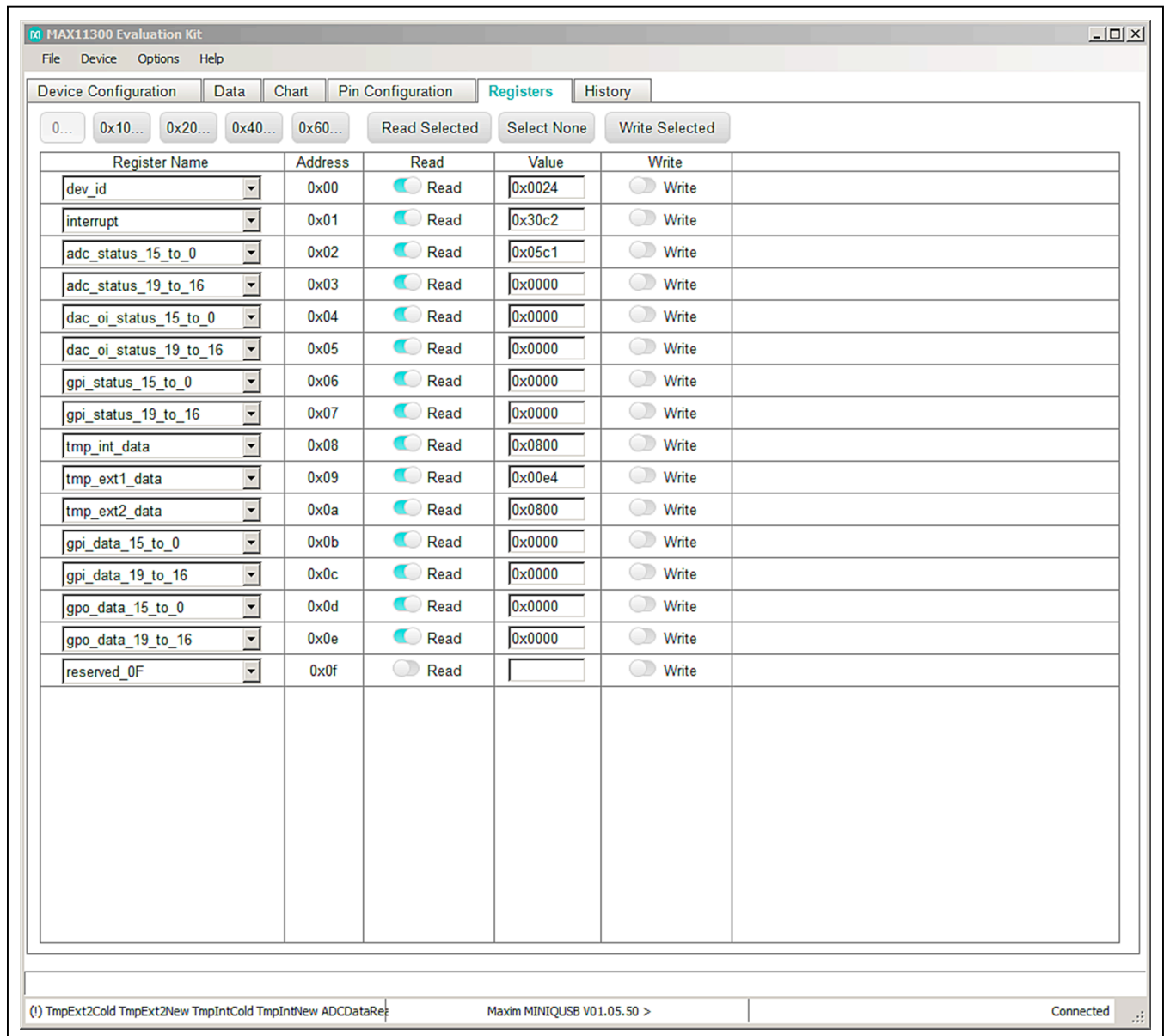

Figure 6. Registers Tab

### Detailed Description of Hardware

The MAX11300 EV kit uses an on-board MAXQ2000 microcontroller (U120) to send SPI commands to the device. On-board level translators (U101, U102, and U105) convert from 3.3V to 5V levels. On-board MAX6071 voltage references (U3, U6) provide ADC and DAC reference voltages. Remote temperature sensing can be simulated by on-board 3904 npn transistors (D0, D1). See Figure 7.

### Connecting to User-Supplied Circuitry

The EV kit connects to external, user-supplied circuitry through header J1 or J2. These two headers have the same signals; J1 is for vertical 50-pin ribbon-cable connection and J2 is for right-angle connection to a sideboard by standard 0.100in right-angle pins.

If remote temperature sensing is used, disconnect on-board npn transistors D0 and D1 by moving the shunts of JUD0P, JUD0N, JUD1P, and J1D1N to the 1-4 position.

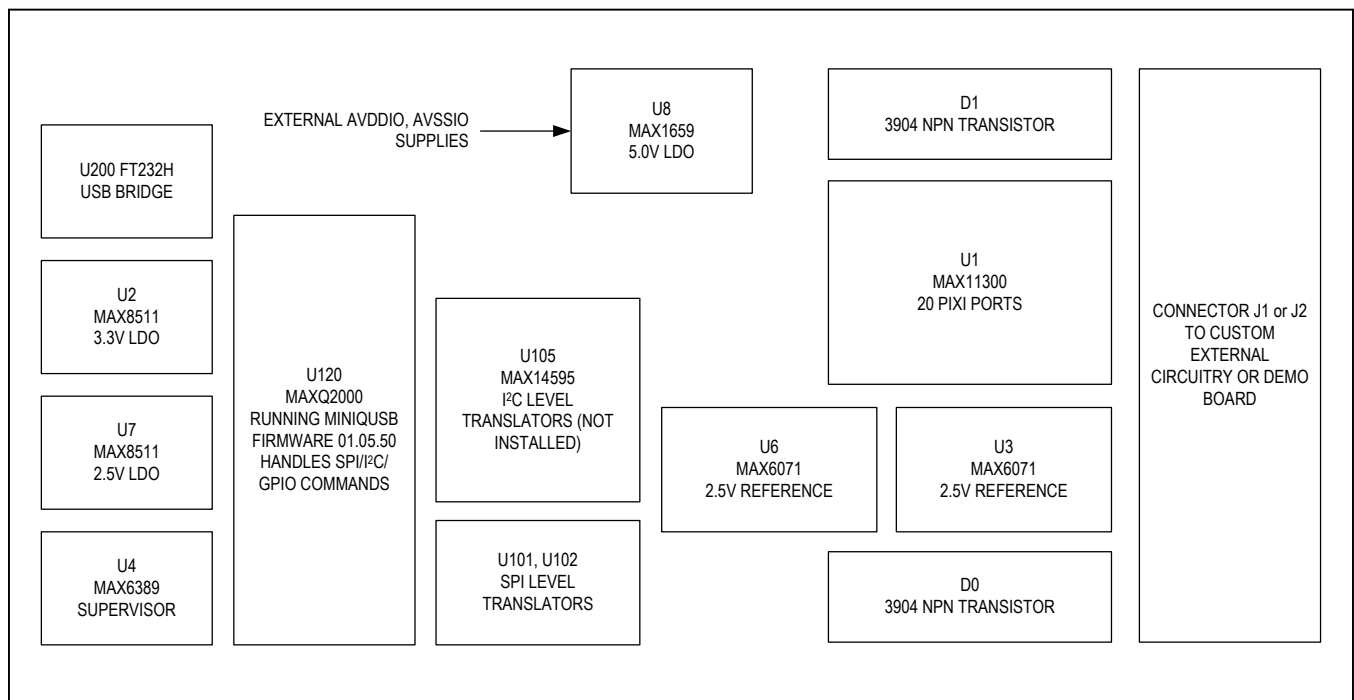

Figure 7. MAX11300 EV Kit Hardware Overview

Table 1. Jumper Configuration (Power Supply)

JUMPER	SIGNAL	SHUNT POSITION	DESCRIPTION
JU_AVSSIO_GND	AVSSIO	No Shunt*	AVSSIO must be supplied by user negative power supply
		1-2	AVSSIO = GND
JU_DVDD	DVDD	1-2*	DVDD is supplied from MAX1659 +5V LDO powered from AVDDIO
		2-3	DVDD is supplied from USB
		No Shunt	DVDD must be supplied by user power supply
JU_AVDD	AVDD	1-2*	AVDD is supplied from DVDD directly
		2-3	AVDD is supplied from DVDD, filtered by RAVDD and CAVDD
		No Shunt	AVDD must be supplied by user power supply

**Table 1. Jumper Configuration (Power Supply) (continued)**

JUMPER	SIGNAL	SHUNT POSITION	DESCRIPTION
JU_U1_AVDDIO	AVDDIO	1-2**	Measure the supply current by putting a current meter in series with the jumper.
JU_U1_AVSSIO	AVSSIO	1-2**	Measure the supply current by putting a current meter in series with the jumper.
JU_U1_AVDD	AVDD	1-2**	Measure the supply current by putting a current meter in series with the jumper.
JU_U1_DVDD	DVDD	1-2**	Measure the supply current by putting a current meter in series with the jumper.

\*Default position.

\*\*Default connection by a trace on the PCB; jumper pins not installed; shunt not included.

**Table 2. Jumper Configuration (Digital Interface)**

JUMPER	SIGNAL	SHUNT POSITION	DESCRIPTION
JU_SDA_DIN	SDA_DIN	1-2**	SDA_DIN = MAXQ_MOSI (SPI interface mode)
		2-3	SDA_DIN = MAXQ_SDA (reserved)
		No Shunt	SDA_DIN = User-supplied connection
JU_SDA	SDA	1-2	SDA pullup to DVDD by R103 (reserved)
		No Shunt*	R103 is not connected (SPI interface mode)
JU_SCL_SCLK	SCL_SCLK	1-2**	SCL_SCLK = MAXQ_SCLK (SPI interface mode)
		2-3	SCL_SCLK = MAXQ_SCL (reserved)
		No Shunt	SCL_SCLK = User-supplied connection
JU_SCL	SCL	1-2	SCL pullup to DVDD by R104 (reserved)
		No Shunt*	R104 is not connected (SPI interface mode)
JU_AD0_CSB	AD0/CSB	1-2**	AD0/CSB = MAXQ_CS (SPI interface mode)
		3-4	AD0/CSB = DVDD (reserved)
		5-6	AD0/CSB = SCL_SCLK (reserved)
		7-8	AD0/CSB = SDA_DIN (reserved)
		9-10	AD0/CSB = DGND. (reserved)
JU_AD1_DOUT	AD1/DOOUT	1-2	AD1/DOOUT = DGND (reserved)
		1-3**	AD1/DOOUT = MAXQ_MOSI.(SPI interface mode)
		1-4	AD1/DOOUT = DVDD (reserved)
JU_INTB	INTB	1-2**	INTB = MAXQ_K5 interrupt input to microcontroller
		Open	INTB = user-supplied connection
JU_CNVTB	CNVTB	1-2**	CNVTB = MAXQ_K4 output from microcontroller
		Open	CNVTB = user-supplied connection

\*Default position.

\*\*Default connection by a trace on the PCB; jumper pins not installed; shunt not included.

**Table 3. MAX11300EVKIT Jumper Configuration (Temperature Sensor)**

JUMPER	SIGNAL	SHUNT POSITION	DESCRIPTION
JUD0P	D0P	1-2	10Ω resistor RD0P emulates long connection wire series resistance, using on-board MMBT3904 as temp sensor
		1-3*	Direct connection to on-board MMBT3904 used as temp sensor
		1-4	Connect external temperature sense diode junction to D0P_ext / D0N_ext pair on header J1, J2, or J3
JUD0N	D0N	1-2	10Ω resistor RD0N emulates long connection wire series resistance, using on-board MMBT3904 as temp sensor
		1-3*	Direct connection to on-board MMBT3904 used as temp sensor
		1-4	Connect external temperature sense diode junction to D0P_ext / D0N_ext pair on header J1, J2, or J3
JUD1P	D1P	1-2	10Ω resistor RD1P emulates long connection wire series resistance, using on-board MMBT3904 as temp sensor
		1-3*	Direct connection to on-board MMBT3904 used as temp sensor
		1-4	Connect external temperature sense diode junction to D1P_ext / D1N_ext pair on header J1, J2, or J3
JUD1N	D1N	1-2	10Ω resistor RD1N emulates long connection wire series resistance, using on-board MMBT3904 as temp sensor
		1-3*	Direct connection to on-board MMBT3904 used as temp sensor
		1-4	Connect external temperature sense diode junction to D1P_ext / D1N_ext pair on header J1, J2, or J3

\*Default position.

**Table 4. MAX11300EVKIT Jumper Configuration (On-Board External References)**

JUMPER	SIGNAL	SHUNT POSITION	DESCRIPTION
JU_ADC_REF	ADC_EXT_REF	1-2*	On-board MAX6071 reference U2 drives ADC_EXT_REF
		Open	On-board MAX6071 reference U2 is disconnected from ADC_EXT_REF
JU_DAC_REF	DAC_REF	1-2*	On-board MAX6071 reference U3 drives DAC_REF (Kelvin connection force)
		Open	On-board MAX6071 reference U3 is disconnected from DAC_REF
JU_DAC_REFS	DAC_REFS	1-2*	On-board MAX6071 reference U3 drives DAC_REF (Kelvin connection sense)
		Open	On-board MAX6071 reference U3 is disconnected from DAC_REF

\*Default position.



**Table 5. MAX11300EVKIT Jumper Configuration (Microcontroller)**

JUMPER	SIGNAL	SHUNT POSITION	DESCRIPTION
JU_LED1	MAXQ_K1	1-2*	MAXQ2000 port 0.0 (MINIUSB firmware signal K1) drives diagnostic indicator LED1
		Open	MAXQ2000 port 0.0 (MINIUSB firmware signal K1) is disconnected from LED1
JU_LED2	MAXQ_K2	1-2*	MAXQ2000 port 0.1 (MINIUSB firmware signal K2) drives diagnostic indicator LED2
		Open	MAXQ2000 port 0.1 (MINIUSB firmware signal K2) is disconnected from LED2
JU_LED3	MAXQ_K3	1-2*	MAXQ2000 port 0.2 (MINIUSB firmware signal K3) drives diagnostic indicator LED3
		Open	MAXQ2000 port 0.2 (MINIUSB firmware signal K3) is disconnected from LED3

\*Default position.

**Table 6. Microcontroller Resources**

GPIO SIGNAL	DIRECTION	JUMPER	DESCRIPTION
MAXQ_K1	Output from MAXQ2000	JU_LED1	Diagnostic indicator LED1
MAXQ_K2	Output from MAXQ2000	JU_LED2	Diagnostic indicator LED2
MAXQ_K3	Output from MAXQ2000	JU_LED3	Diagnostic indicator LED3
MAXQ_K4	Output from MAXQ2000	JU_CNVTB	Convert-Start signal to MAX11300 CVNBT input
MAXQ_K5	Interrupt input to MAXQ2000	JU_INTB	Active-low Interrupt from MAX11300 INTB output; can also be triggered by momentary pushbutton INT0.
MAXQ_K6	Interrupt input to MAXQ2000	—	Active-low Interrupt from momentary pushbutton INT1
MAXQ_K7	Interrupt input to MAXQ2000	—	Active-low Interrupt from momentary pushbutton INT2
MAXQ_K8	Interrupt input to MAXQ2000	—	Active-low Interrupt from momentary pushbutton INT3

**Table 7. Test Point Voltages**

TEST POINT	VOLTAGE (V)		
	NOMINAL	MINIMUM	MAXIMUM
+3.3V TP142 from U2 MAX8511	3.3	3.267	3.333
+2.5V TP132 from U7 MAX8511	2.5	2.475	2.52
+5V from U8 MAX1659	5.0	4.85	5.15
DVDD from U8 MAX1659	5.0	4.85	5.15
ADC_INT_REF from U1 MAX11300	2.5	2.494	2.506
ADC_EXT_REF from U6 MAX6071	2.5	2.4	2.6
DAC_REF from U3 MAX6071	2.5	2.4	2.6



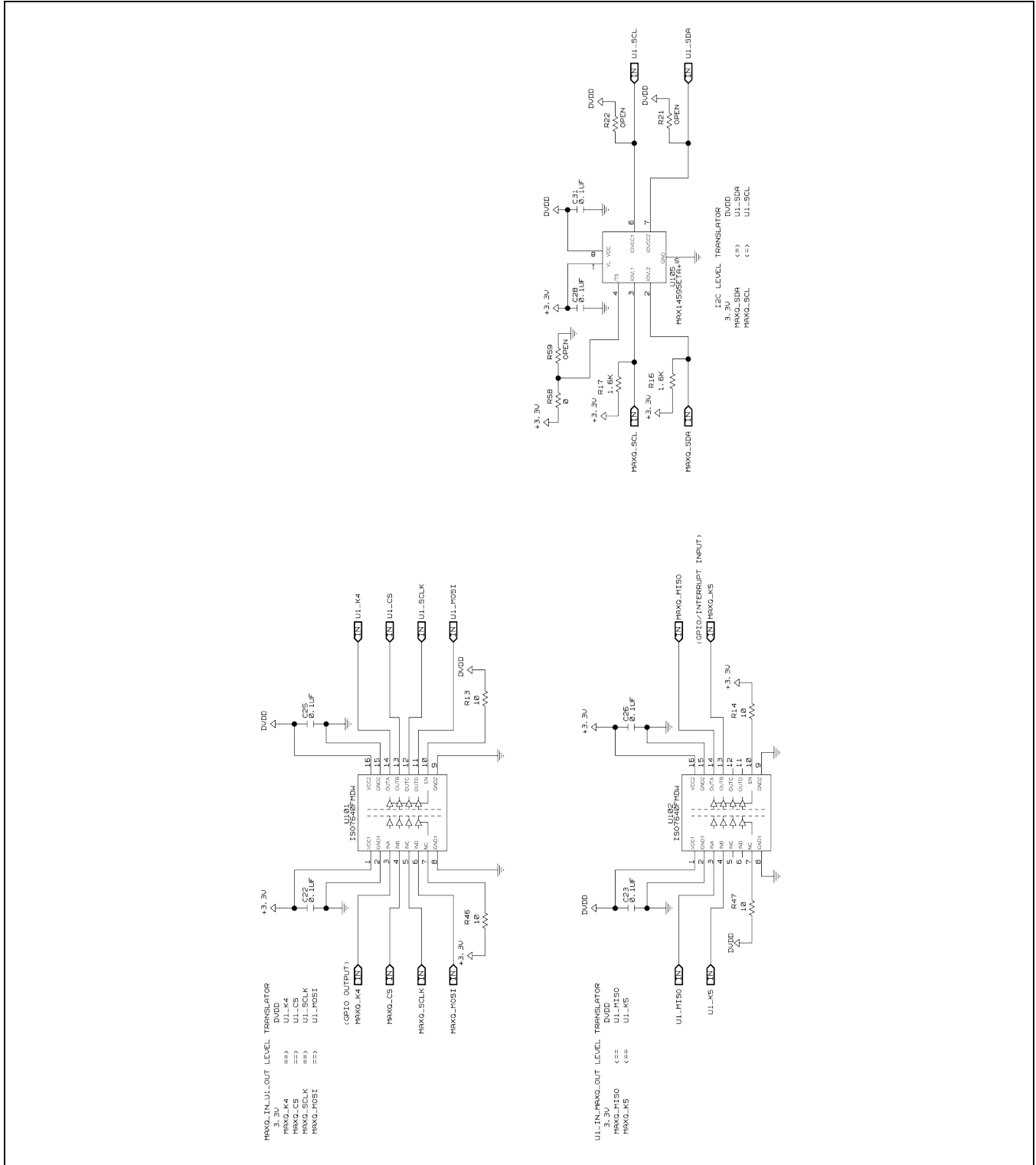

Figure 8b. MAX11300 EV Kit Schematic (Sheet 2 of 5)





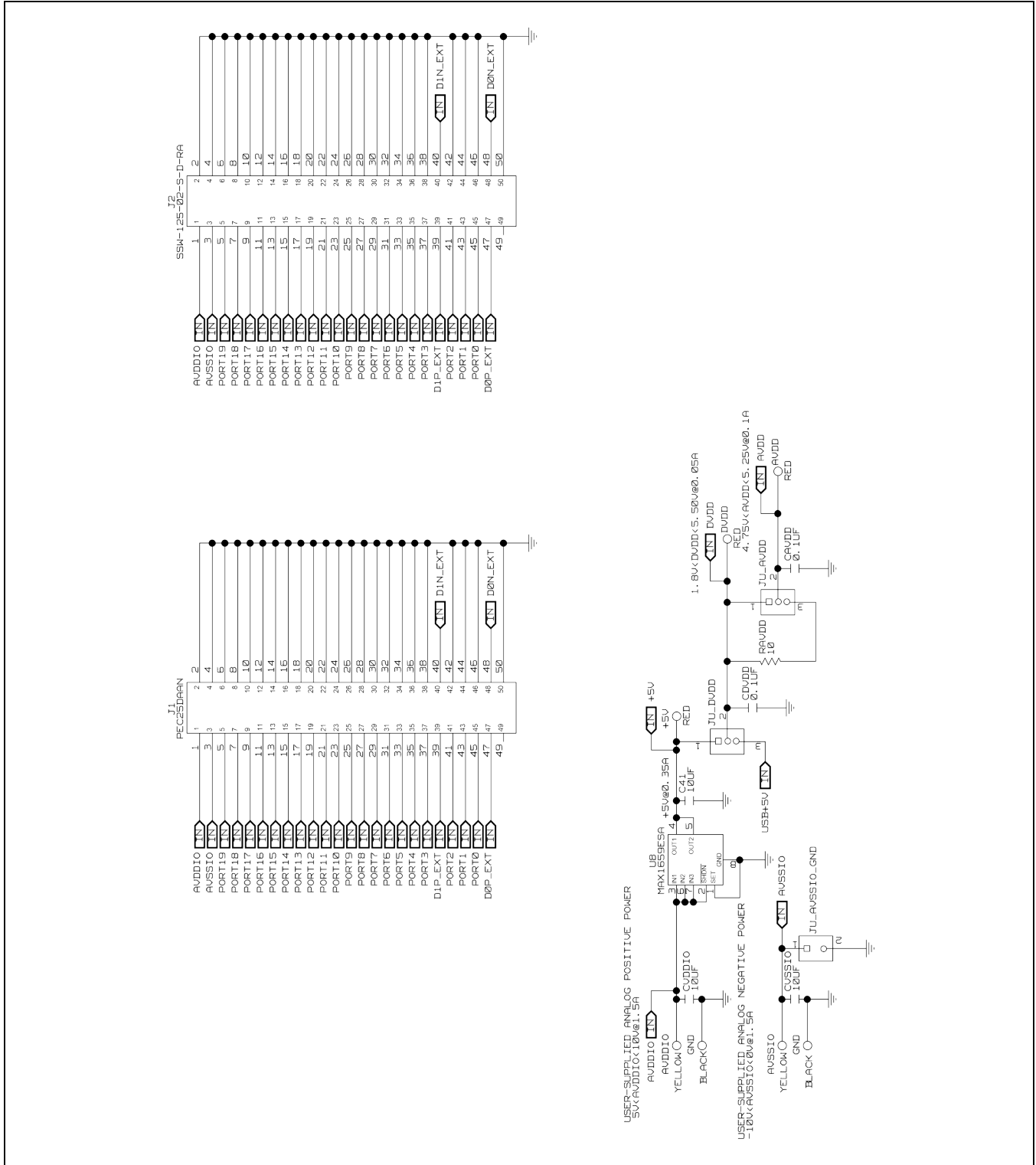

Figure 8e. MAX11300 EV Kit Schematic (Sheet 5 of 5)



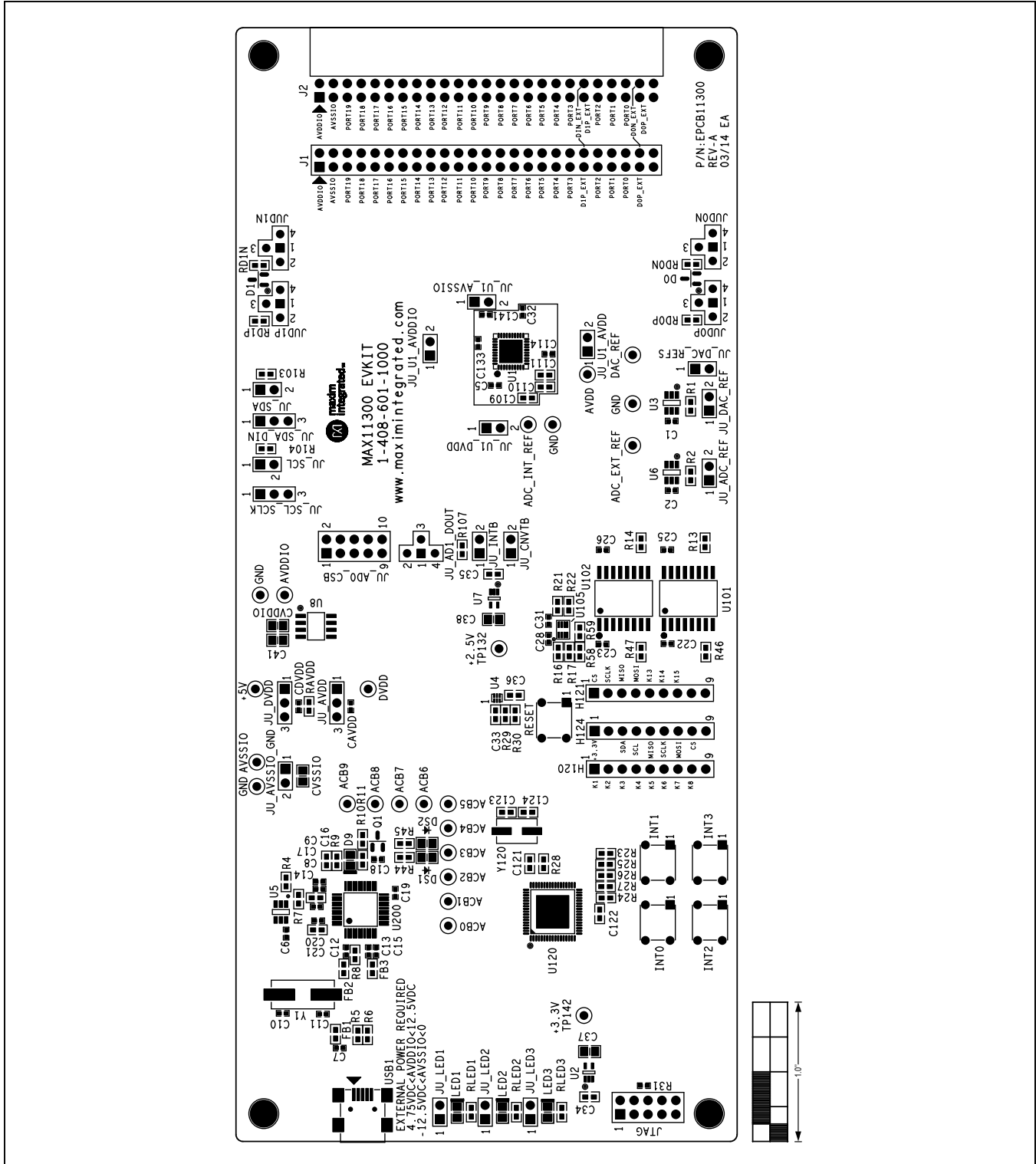

Figure 9. MAX11300 EV Kit Component Placement Guide—Component Side

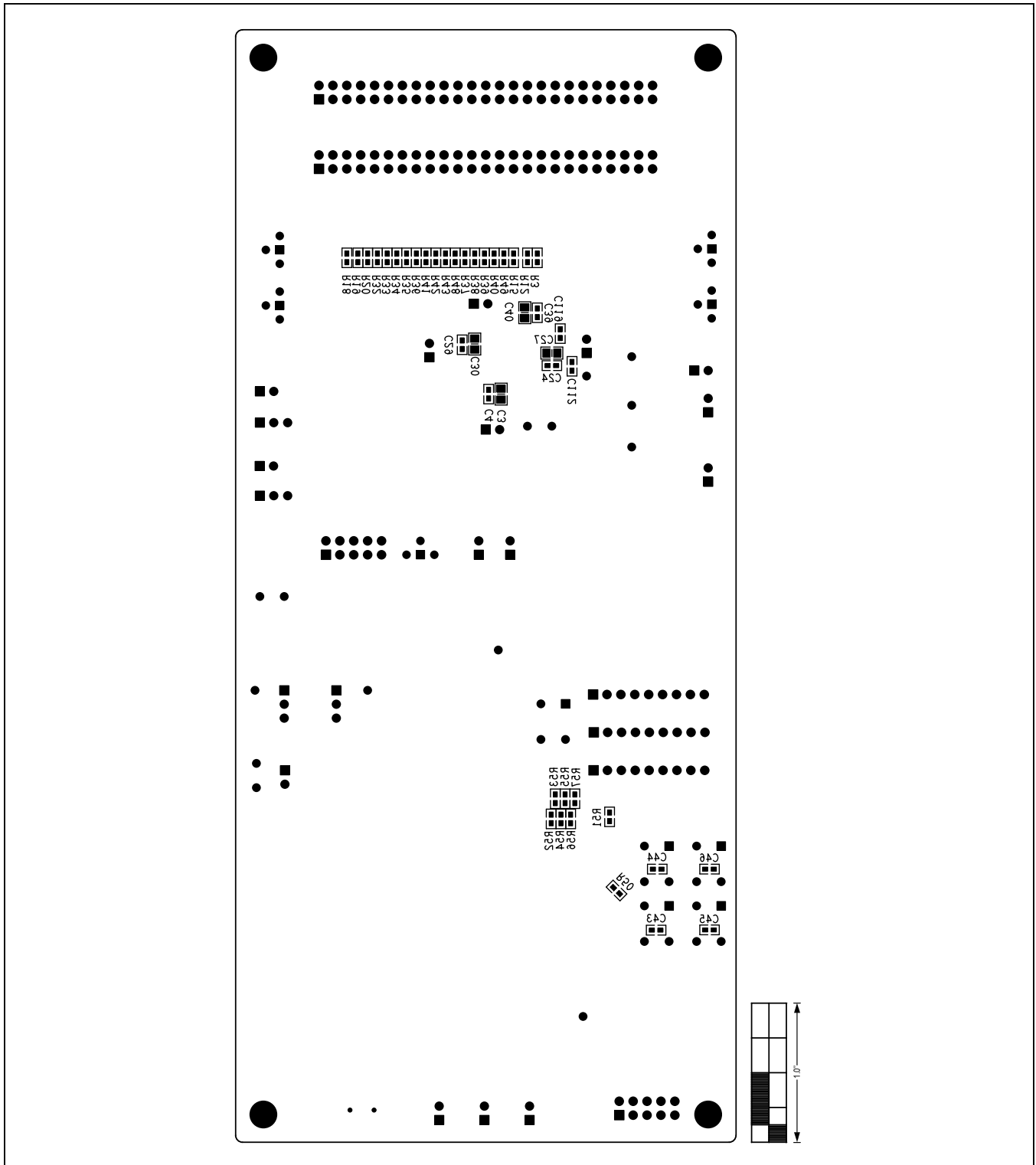

Figure 10. MAX11300 EV Kit Component Placement Guide—Solder Side

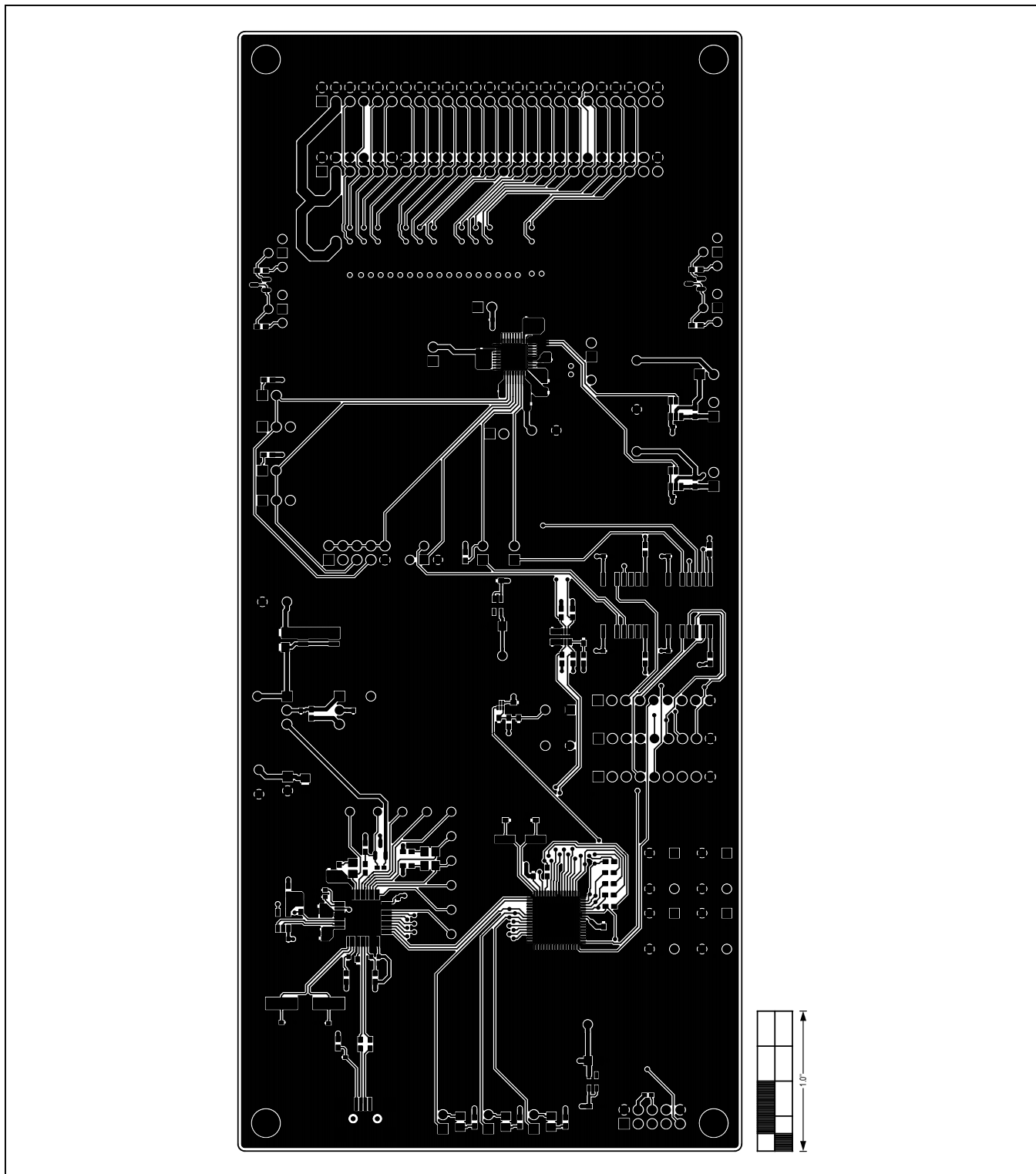

Figure 11. MAX11300 EV Kit PCB Layout—Component Side

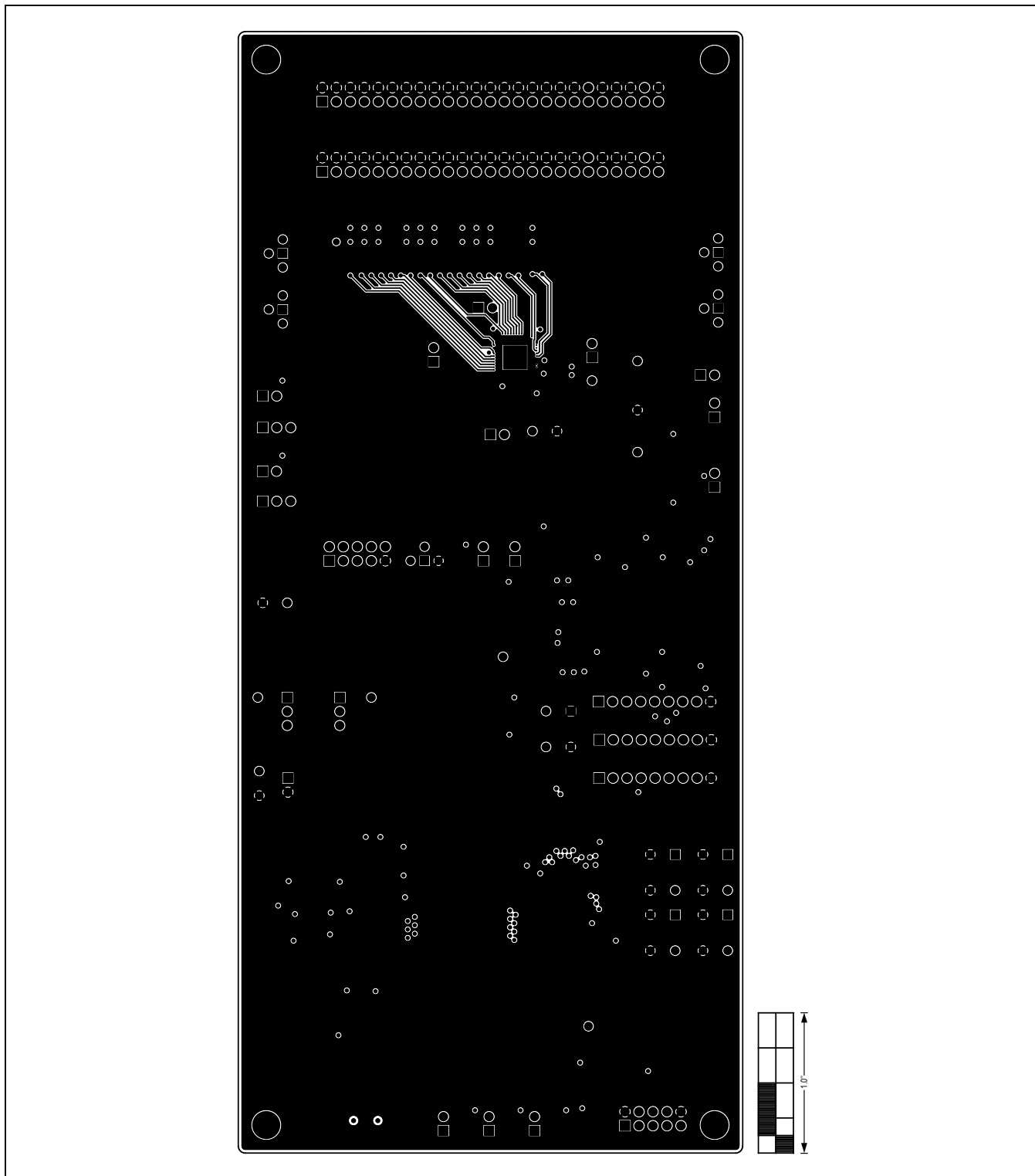

Figure 12. MAX11300 EV Kit PCB Layout—Ground Layer 2



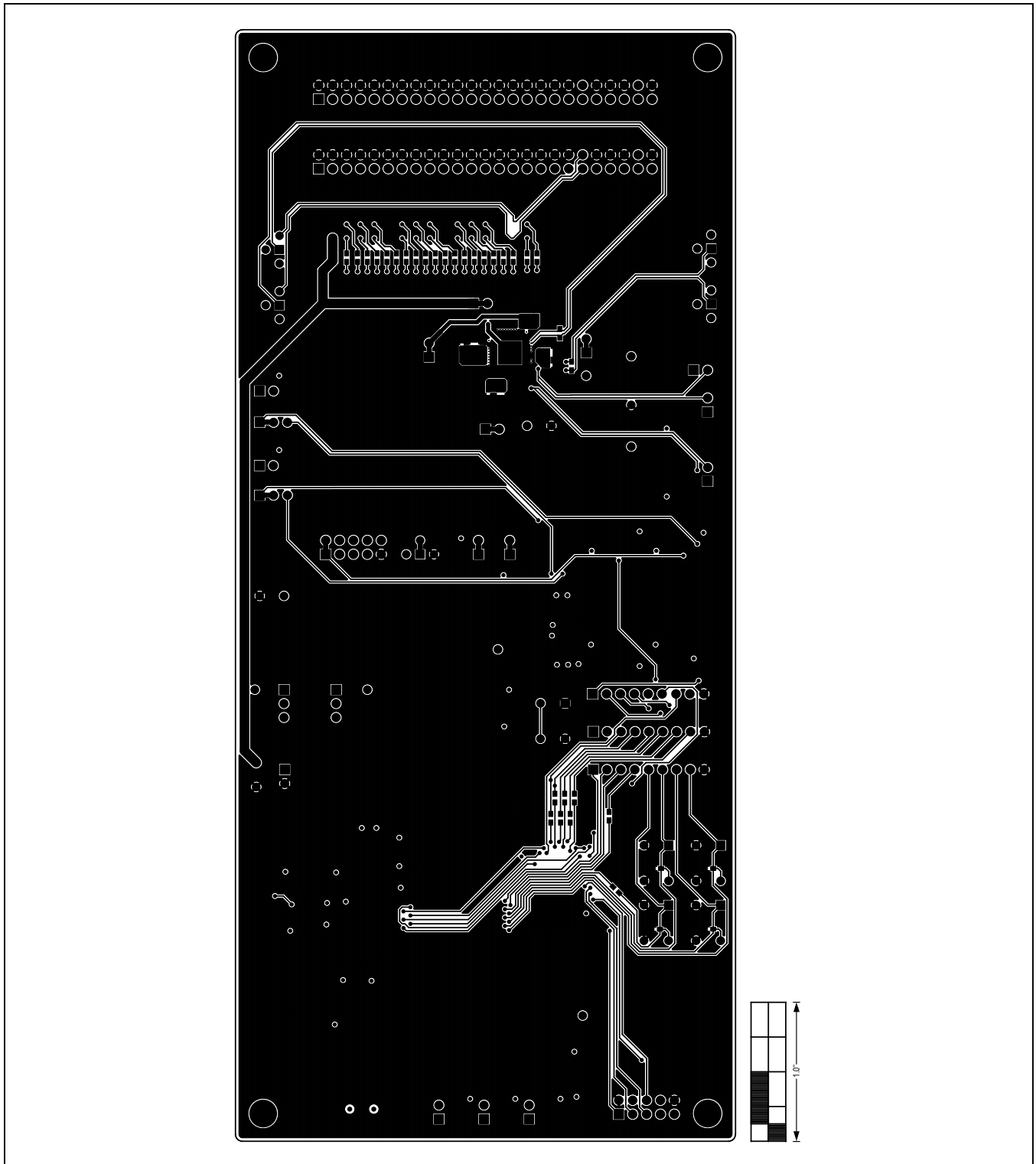

Figure 14. MAX11300 EV Kit PCB Layout—Solder Side



### Component List

Click on the link below for component information:

- [MAX11300 BOM](#)

### Ordering Information

PART	TYPE
MAX11300EVKIT#	EV Kit

*#Denotes RoHS compliant.*

## Revision History

REVISION NUMBER	REVISION DATE	DESCRIPTION	PAGES CHANGED
0	5/14	Initial release	—
1	1/15	Replaced Figure 1	2

For pricing, delivery, and ordering information, please contact Maxim Direct at 1-888-629-4642, or visit Maxim Integrated's website at [www.maximintegrated.com](http://www.maximintegrated.com).

*Maxim Integrated cannot assume responsibility for use of any circuitry other than circuitry entirely embodied in a Maxim Integrated product. No circuit patent licenses are implied. Maxim Integrated reserves the right to change the circuitry and specifications without notice at any time.*

TITLE: Bill of Materials

DATE: 03/20/2014

DESIGN: max11300\_evkit\_a

TEMPLATE: \\cavnds02a.maxim-ic.com\tp\_loc\hw\_cardcat\allegrolib\site\cdssetup\BOM\_Templates\evkit\_build\_template.bom

CALLOUT:

VARIANT: openvariant

Revision\_Type : PRODUCTION

ITEM	QTY	REF DES	Var Status	MAXINV	MFG PART #	MANUFACTURER	VALUE	DESCRIPTION	COMMENTS
1	3	+5V, AVDD, DVDD	Pref	02-TPMINI5000-00	5000	?	N/A	TEST POINT; PIN DIA=0.1IN; TOTAL LENGTH=0.3IN; BOARD HOLE=0.04IN; RED; PHOSPHOR BRONZE WIRE SILVER PLATE FINISH; RECOMMENDED FOR BOARD THICKNESS=0.062IN; NOT FOR COLD TEST	
2	10	ACB0-ACB9	Pref	N/A	N/A	?	N/A	TEST POINT; PAD DIA=0.06IN	
3	3	DAC_REF, ADC_EXT_REF, ADC_INT_REF	Pref	02-TPMINI5002-00	5002	?	N/A	TEST POINT; PIN DIA=0.1IN; TOTAL LENGTH=0.3IN; BOARD HOLE=0.04IN; WHITE; PHOSPHOR BRONZE WIRE SILVER; NOT FOR COLD TEST	
4	25	C1, C2, C5, C6, C9, C12-C15, C17-C20, C22, C23, C25, C26, C28, C31, C32, C114, C133, C141, CAVDD, CDVDD	Pref	20-000U1-B8	N/A	?	0.1UF	CAPACITOR; SMT (0402); CERAMIC CHIP; 0.1UF; 10V; TOL=10%; MODEL=GRM SERIES; TG=-55 DEGC TO +125 DEGC; TC=X7R; NOT RECOMMENDED FOR NEW DESIGN-USE 20-000u1-04A	
5	9	C3, C27, C30, C37, C38, C40, C41, CVDDIO, CVSSIO	Pref	20-0010U-S6	GRM21BR71A106KE51	?	10UF	CAPACITOR; SMT (0805); CERAMIC CHIP; 10UF; 10V; TOL=10%; MODEL=GRM SERIES; TG=-55 DEGC TO +125 DEGC; TC=X7R	

6	11	C4, C21, C24, C29, C34, C35, C39, C43-C46	Pref	20-0001U-63	N/A	?	1UF	CAPACITOR; SMT (0603); CERAMIC CHIP; 1UF; 16V; TOL=10%; MODEL=; TG=-55 DEGC TO +125 DEGC; TC=X7R
7	1	C7	Pref	20-00U01-B19	N/A	?	0.01UF	CAPACITOR; SMT (0402); CERAMIC CHIP; 0.01UF; 16V; TOL=10%; MODEL=; TG=-55 DEGC TO +125 DEGC; TC=X7R
8	5	C8, C16, C109-C111	Pref	20-004U7-X3	N/A	?	4.7UF	CAPACITOR; SMT (0603); CERAMIC; 4.7UF; 6.3V; TOL=20%; MODEL=C SERIES; TG=-55 DEGC TO +85 DEGC; TC=X5R
9	2	C10, C11	Pref	20-0027P-27	N/A	?	27PF	CAPACITOR; SMT; 0402; CERAMIC; 27pF; 50V; 5%; C0G; -55degC to +125degC; 0 +/-30PPM/degC
10	4	C33, C36, C121, C122	Pref	20-000U1-03	N/A	?	0.1UF	CAPACITOR; SMT; 0603; CERAMIC; 0.1uF; 25V; 10%; X7R; -55degC to +125degC; +/-15% from -55degC to +125degC; NOT RECOMMENDED FOR NEW DESIGN USE - 20-000u1-01
11	2	C112, C119	Pref	20-0390P-E4	N/A	?	390PF	CAPACITOR; SMT (0603); CERAMIC CHIP; 390PF; 100V; TOL=10%; MODEL=C0G; TG=-55 DEGC TO +125 DEGC; TC=+
12	2	C123, C124	Pref	20-0010P-25	N/A	?	10PF	CAPACITOR; SMT; 0603; CERAMIC; 10pF; 50V; 5%; C0G; -55degC to +125degC, USE 20-0010p-E4 FOR NEW DESIGN

13	2	D0, D1	Pref	90-MMBT3904-16	MMBT3904	N/A	MMBT3904	TRANSISTOR, NPN, SOT-23, PD=0.225W, IC=0.2A, VCEO=40V
14	4	D9, LED1-LED3	Pref	30-LTSTC171KSKT-00	LTST-C171KSKT	LITE-ON ELECTRONICS INC	LTST-C171KSKT	DIODE; LED; STANDARD; YELLOW; SMT (0805); PIV=5.0V; IF=0.08A
15	1	DS1	Pref	30-LTSTC171GKT-00	LTST-C171GKT	LITE-ON ELECTRONICS; INC.	LTST-C171GKT	DIODE; LED; STANDARD; GREEN; SMT (0805); PIV=5.0V; IF=0.12A; -55 DEGC TO +85 DEGC
16	1	DS2	Pref	30-LTSTC171KRKT-00	LTST-C171KRKT	LITE-ON ELECTRONICS; INC.	LTST-C171KRKT	DIODE; LED; STANDARD; RED; SMT (0805); PIV=5.0V; IF=0.08A; -55 DEGC TO +85 DEGC
17	3	FB1-FB3	Pref	50-00600-S8	MMZ1608B601C	TDK	600	INDUCTOR; SMT (0603); FERRITE- BEAD; 600; TOL=+/-25%; 0.5A; -55 DEGC TO +125 DEGC
18	4	GND_TP1-GND_TP4	Pref	02-TPMINI5001-00	5001	?	N/A	TEST POINT; PIN DIA=0.1IN; TOTAL LENGTH=0.3IN; BOARD HOLE=0.04IN; BLACK; PHOSPHOR BRONZE WIRE SILVER PLATE FINISH; RECOMMENDED FOR BOARD THICKNESS=0.062IN; NOT FOR COLD TEST
19	3	H120, H121, H124	Pref	01-PEC09SAAN9P-21	PEC09SAAN	SULLINS ELECTRONICS CORP	PEC09SAAN	CONNECTOR; MALE; THROUGH HOLE; BREAKAWAY; STRAIGHT; 9PINS; -65 DEGC TO +125 DEGC
20	5	INT0-INT3, RESET	Pref	11-B3F1000-00	B3F-1000	OMRON	B3F-1000	SWITCH; SPST; THROUGH HOLE; 24V; 0.05A; NORMALLY OPEN-HIGH FORCE TACTILE SWITCH; RCOIL= OHM; RINSULATION= OHM; OMRON

21	1	J1	Pref	01-PEC25DAAN50P-21	PEC25DAAN	SULLINS ELECTRONICS CORP.	PEC25DAAN	CONNECTOR; MALE; THROUGH HOLE; BREAKAWAY; STRAIGHT; 50PINS; -65 DEGC TO +125 DEGC
22	1	J2	Pref	01-SSW12502SDRA50P-17	SSW-125-02-S-D-RA	SAMTEC	SSW-125-02-S-D-RA	CONNECTOR; FEMALE; THROUGH HOLE; SQ POST SOCKET; RIGHT ANGLE; 50PINS
23	1	JTAG	Pref	01-PEC05DAAN10P-21	PEC05DAAN	SULLINS ELECTRONICS CORP.	PEC05DAAN	CONNECTOR; MALE; THROUGH HOLE; BREAKAWAY; STRAIGHT; 10PINS; -65 DEGC TO +125 DEGC
24	4	JUDON, JUD0P, JUD1N, JUD1P	Pref	01-222840434P-21	22-28-4043	MOLEX	22-28-4043	CONNECTOR; MALE; THROUGH HOLE; FLAT VERTICAL BREAKAWAY; STRAIGHT; 4PINS
25	7	JU_LED1-JU_LED3, JU_ADC_REF, JU_DAC_REF, JU_DAC_REFS, JU_VSSIO_GND	Pref	01-PEC02SAAN2P-21	PEC02SAAN	SULLINS	PEC02SAAN	CONNECTOR; MALE; THROUGH HOLE; BREAKAWAY; STRAIGHT; 2PINS; -65 DEGC TO +125 DEGC
26	2	JU_AVDD, JU_DVDD	Pref	01-PEC03SAAN3P-21	PEC03SAAN	SULLINS	PEC03SAAN	CONNECTOR; MALE; THROUGH HOLE; BREAKAWAY; STRAIGHT; 3PINS; -65 DEGC TO +125 DEGC
27	1	Q1	Pref	90-IRLML6402-16	IRLML6402	INTERNATIONAL RECTIFIER	IRLML6402	TRAN; HEXFET POWER MOSFET; PCH; SOT-23; PD-(1.3W); I-(-3.7A); V-(-20V)
28	3	R1, R2, R11	Pref	80-0100K-24	N/A	?	100K	RESISTOR; 0603; 100K; 1%; 100PPM; 0.10W; THICK FILM
29	28	R3, R12, R15, R18-R20, R32-R43, R48-R57	Pref	80-0000R-27A	N/A	?	0	RESISTOR; 0603; 0 OHM; 5%; JUMPER; 0.10W; THICK FILM
30	2	R4, R29	Pref	80-0010K-24	N/A	?	10K	RESISTOR; 0603; 10K; 1%; 100PPM; 0.10W; THICK FILM
31	11	R5, R6, R13, R14, R46, R47, RD0N, RD0P, RD1N, RD1P, RAVDD	Pref	80-0010R-24	N/A	?	10	RESISTOR; 0603; 10 OHM; 1%; 100PPM; 0.10W; THICK FILM



32	2	R7, R10	Pref	80-0002K-24	N/A	?	2K	RESISTOR, 0603, 2K OHM, 1%, 100PPM, 0.10W, THICK FILM
33	1	R8	Pref	80-0012K-24	N/A	?	12K	RESISTOR, 0603, 12K OHM, 1%, 100PPM, 0.10W, THICK FILM
34	3	R9, R44, R45	Pref	80-0470R-24	N/A	?	470	RESISTOR, 0603, 470 OHM, 1%, 100PPM, 0.10W, THICK FILM
35	2	R16, R17	Pref	80-001K6-53	N/A	?	1.6K	RESISTOR; 0603; 1.6K OHM; 5%; 200PPM; 0.10W; THICK FILM
36	1	R23	Pref	80-003K3-24	N/A	?	3.3K	RESISTOR, 0603, 3.3K OHM, 1%, 100PPM, 0.10W, THICK FILM
37	6	R24-R28, R58	Pref	80-0000R-27	N/A	?	0	RESISTOR; 0603; 0 OHM; 0%; JUMPER; 0.10W; THICK FILM
38	1	R30	Pref	80-0015K-24	N/A	?	15K	RESISTOR, 0603, 15K OHM, 1%, 100PPM, 0.10W, THICK FILM
39	1	R31	Pref	80-0020K-23	N/A	?	20K	RESISTOR; 0402; 20K OHM; 1%; 100PPM; 0.063W; THICK FILM
40	3	R103, R104, R107	Pref	80-004K7-19	N/A	?	4.7K	RESISTOR; 0603; 4.7K; 1%; 100PPM; 0.10W; THICK FILM
41	1	RUBBER_BUMPS	Pref	N/A	SJ-5007	3M	SJ-5007	EVKIT BUMPERS; SQUARE TAPERED; WHITE-SET TO OBSOLETE; PLEASE USE 02-SJ5007-09
42	12	SU1, SU2, SU7-SU13, SU15-SU17	Pref	02-JMPFS1100B-00	SX1100-B	KYCON	SX1100-B	TEST POINT; JUMPER; STR; TOTAL LENGTH=0.24IN; BLACK; INSULATION=PBT;PHOSPHOR BRONZE CONTACT=GOLD PLATED
43	1	U1	Pref	MAX11300GTL+	MAX11300GTL+	MAXIM	MAX11300GTL+	EVKIT PART - IC; MAX11300GTL+; PACKAGE CODE T4066-3

44	1	U2	Pref	MAX8511EXK33+	MAX8511EXK33+	MAXIM	MAX8511EXK33	IC; VREG; ULTRA-LOW-NOISE, HIGH PSRR, LOW-DROPOUT, LINEAR REGULATOR; SC70-5 ; -40 DEGC TO +85 DEGC	MAX8511EXK33+
45	2	U3, U6	Pref	MAX6071AAUT25+	MAX6071AAUT25+	MAXIM	MAX6071AAUT25+	IC; VREF; LOW NOISE; HIGH-PRECISION SERIES VOLTAGE REFERENCE; SOT23-6	MAX6071AAUT25+
46	1	U4	Pref	MAX6389LT31D3+	MAX6389LT31D3+	MAXIM	MAX6389LT31D3+	IC; UP; DUAL LOW-VOLTAGE; LOW-POWER UP RESET CIRCUIT; UDFN6	MAX6389LT31D3+
47	1	U7	Pref	MAX8511EXK25+	MAX8511EXK25+	MAXIM	MAX8511EXK25-T	IC; VREG; ULTRA-LOW-NOISE HIGH PSRR LOW-DROPOUT LINEAR REGULATOR; SC70-5 ; -40 DEGC TO +85 DEGC	MAX8511EXK25+
48	1	U8	Pref	MAX1659ESA	MAX1659ESA	MAXIM	MAX1659ESA	IC; VREG; LOW-DROPOUT LINEAR REGULATOR; NSOIC8	MAX1659ESA
49	2	U101, U102	Pref	10-ISO7640FMDW-W	ISO7640FMDW	TEXAS INSTRUMENTS	ISO7640FMDW	IC; DISO; LOW POWER QUAD CHANNELS DIGITAL ISOLATOR; WSOIC16 300MIL	
50	1	U105	Pref	MAX14591ETA+	MAX14591ETA+	MAXIM	MAX14591ETA+	IC; TRANS; HIGH-SPEED; OPEN-DRAIN CAPABLE LOGIC-LEVEL TRANSLATOR; TDFN8	MAX14591ETA+
51	1	U120	Pref	MAXQ2000-RAX+	MAXQ2000-RAX+	MAXIM	MAXQ2000-RAX	IC, CTRL, LOW-POWER LCD MICROCONTROLLER, QFN68	MAXQ2000-RAX+
52	1	U200	Pref	10-FT232HL-C	FT232HL	FUTURE TECHNOLOGY DEVICES INTL LTD.	FT232HL	IC; INFC; SINGLE CHANNEL HI-SPEED USB TO MULTIPURPOSE UART/FIFO; LQFP48	
53	1	USB1	Pref	01-10033526N3212MLF5P-26	10033526-N3212MLF	FCI CONNECT	10033526-N3212MLF	CONNECTOR; FEMALE; SMT; MINI USB B-TYPE SMT RECEPTACLE; RIGHT ANGLE; SPINS	

54	2	VDDIO, VSSIO	Pref	02-TPMINI5004-00	5004	?	N/A	TEST POINT; PIN DIA=0.1IN; TOTAL LENGTH=0.3IN; BOARD HOLE=0.04IN; YELLOW; PHOSPHOR BRONZE WIRE SILVER PLATE FINISH; RECOMMENDED FOR BOARD THICKNESS=0.062IN; NOT FOR COLD TEST	
55	1	Y1	Pref	60-0012M-12B	ATS12ASM-1E	CTS	12MHZ	CRYSTAL; SMT ; ATS SERIES; 12PF; 12MHZ; +/-30PPM; +/-50PPM; -40 DEGC TO +85 DEGC	
56	1	Y120	Pref	60-0020M-24A	ECS-200-20-3X	ECS INC.	20MHZ	CRYSTAL; SMT ; CSM-3X SERIES; 20PF; 20MHZ; +/-30PPM; +/-50PPM; -10 DEGC TO +70 DEGC	
57	1		Pref	EPCB11300	EPCB11300	MAXIM	PCB	PCB: EPCB11300	
TOTAL	212								
DO NOT PURCHASE									
ITEM	QTY	REF DES	Var Status	MAXINV	MFG PART #	MANUFACTURER	VALUE	DESCRIPTION	COMMENTS
1	1	JU_AD0_CSB	DNI	01-PEC05DAAN10P-21	PEC05DAAN	SULLINS ELECTRO	PEC05DAAN	CONNECTOR; MALE; THROUGH HOLE; BREAKAWAY; STRAIGHT; 10PINS; -65 DEGC TO +125 DEGC	
2	1	JU_AD1_DOUT	DNI	01-222840434P-21	22-28-4043	MOLEX	22-28-4043	CONNECTOR; MALE; THROUGH HOLE; FLAT VERTICAL BREAKAWAY; STRAIGHT; 4PINS	
3	6	JU_INTB, JU_CNVTB, JU_U1_AVDD,	DNI	01-PEC02SAAN2P-21	PEC02SAAN	SULLINS	PEC02SAAN	CONNECTOR; MALE; THROUGH HOLE; BREAKAWAY; STRAIGHT; 2PINS; -65 DEGC TO +125 DEGC	DNB
4	2	JU_SCL, JU_SDA	DNI	01-PEC02SAAN2P-21	PEC02SAAN	SULLINS	PEC02SAAN	CONNECTOR; MALE; THROUGH HOLE; BREAKAWAY; STRAIGHT; 2PINS; -65 DEGC TO +125 DEGC	

5	2	JU_SDA_DIN, JU_SCL_SCLK	DNI	01-PEC03SAAN3P-21	PEC03SAAN	SULLINS	PEC03SAAN	CONNECTOR; MALE; THROUGH HOLE; BREAKAWAY; STRAIGHT; 3PINS; -65 DEGC TO +125 DEGC	
6	3	R21, R22, R59	DNI	N/A	N/A	N/A	OPEN	PACKAGE OUTLINE 0603 RESISTOR - EVKIT	
7	3	RLED1-RLED3	DNI	N/A	N/A	N/A	OPEN	PACKAGE OUTLINE 0603 RESISTOR - EVKIT	DNB
8	2	TP132, TP142	DNI	02-TPMINI5000-00	5000 ?		N/A	TEST POINT; PIN DIA=0.1IN; TOTAL LENGTH=0.3IN; BOARD HOLE=0.04IN; RED; PHOSPHOR BRONZE WIRE SILVER PLATE FINISH; RECOMMENDED FOR BOARD THICKNESS=0.062IN; NOT FOR COLD TEST	DNB
9	1	U5	DNI	10-93LC56BTEOT-U	93LC56BT-E/OT	MICROCHIP	93LC56BT-E/OT	IC; EEPROM; 2K; 16-BIT MICROWIRE COMPATIBLE SERIAL EEPROM; SOT23-6	DNB
TOTAL	21								
PACKOUT									
ITEM	QTY	REF DES	MAXINV	MFG PART #	MANUFACTURER	VALUE	DESCRIPTION	STATUS	
1	1	PACKOUT	88-00711-SML	88-00711-SML	N/A	?	BOX;SMALL BROWN 9 3/16"x7"x1 1/4" - PACKOUT	ACTIVE	
2	1	PACKOUT	87-02163-000	87-02163-000	N/A	?	ESD BAG;+;BAG; STATIC SHIELD ZIP 8"x10"; W/ ESD LOGO	ACTIVE	
3	1	PACKOUT	85-MAXKIT-PNK	85-MAXKIT-PNK	N/A	?	PINK FOAM;FOAM;ANTI-STATIC PE 12inX12inX5MM - PACKOUT	ACTIVE	
4	1	PACKOUT	EVINSERT	EVINSERT	N/A	?	WEB INSTRUCTIONS FOR MAXIM DATA SHEET	ACTIVE	
5	1	PACKOUT	85-84003-006	85-84003-006	N/A	?	LABEL(EV KIT BOX) - PACKOUT	ACTIVE	
TOTAL	5								