



UPS340

3 A LOW Vf Schottky Barrier Rectifier

DESCRIPTION

In Microsemi's new Powermite3[®] SMT package, these high efficiency ultrafast rectifiers offer the power handing capabilities previously found only in much larger packages. They are ideal for SMD applications that operate at high frequencies.

In addition to its size advantages, Powermite3[®] package features include a full metallic bottom that eliminates the possibility of solder flux entrapment during assembly, and a unique locking tab acts as an integral heat sink. Its innovative design makes this device ideal for use with automatic insertion equipment.

IMPORTANT: For the most current data, consult MICROSEMI's website: <http://www.microsemi.com>

ABSOLUTE MAXIMUM RATINGS AT 25° C (UNLESS OTHERWISE SPECIFIED)

Rating	Symbol	Value	Unit
Peak Repetitive Reverse Voltage Working Peak Reverse Voltage DC Blocking Voltage	V_{RRM} V_{RWM} V_R	40	V
RMS Reverse Voltage	$V_{R(RMS)}$	28	V
Average Rectified Output Current	I_o	3	A
Non-Repetitive Peak Forward Surge Current 8.3ms Single half sine wave Superimposed on Rated Load @ $T_c = 100^\circ C$	I_{FSM}	50	A
Storage Temperature	T stg	-55 to +150	°C
Operating Temperature	T op	-55 to +125	°C

THERMAL CHARACTERISTICS (UNLESS OTHERWISE SPECIFIED)

Thermal Resistance			
Junction-to Bottom	Rja (1)	2.5	°C/Watt

(1) When Mounted on PC board with 2 ounce copper pattern.

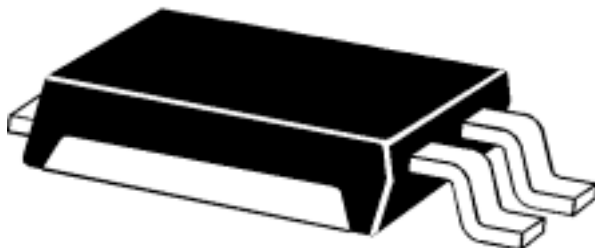

KEY FEATURES

- High power surface mount package.
- Guard Ring die construction for transient protection.
- Silicon Schottky rectifiers no reverse voltage recovery.
- Internal heat sink locking tabs
- Low forward voltage.
- Full metallic bottom eliminates flux entrapment
- Compatible with automatic insertion equipment
- Low profile-maximum height of 1mm supplied in 16 mm tape reel- 5000 units/ 13" reel.

APPLICATIONS/BENEFITS

- Switching and Regulating Power Supplies.
- Charge Pump Circuits.
- Reduces reverse recovery loss due to low I_{RM} .
- Small foot print  =
190 X 300 mils
1:1 Actual size

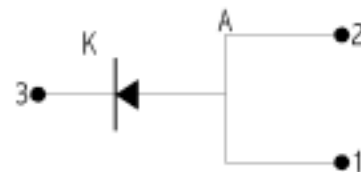

ELECTRICAL PARAMETERS @ 25°C (unless otherwise specified)

Parameter	Symbol	Conditions	Min	Typ.	Max	Units
Forward Voltage (Note 1)	V_{Fm}	$I_F = 3\text{ A}, T_j = 25\text{ °C}$ $I_F = 3\text{ A}, T_j = 125\text{ °C}$ $I_F = 6\text{ A}, T_j = 25\text{ °C}$ $I_F = 6\text{ A}, T_j = 125\text{ °C}$		0.46 0.40 0.57 0.54	0.50 0.44 0.61 0.58	V
Reverse Break Down Voltage (Note 1)	V_{BR}	$I_R = 0.5\text{ mA}$	40			V
Reverse Current (Note1)	I_{rm}	$V_R = 40\text{V}, T_j = 25\text{ °C}$ $V_R = 40\text{V}, T_j = 100\text{ °C}$		15 10	500 20	μA mA
Capacitance	C_T	$V_R = 4\text{ V}; F = 1\text{ MHz}$		180		pF

Note: 1 Short duration test pulse used to minimize self – heating effect.

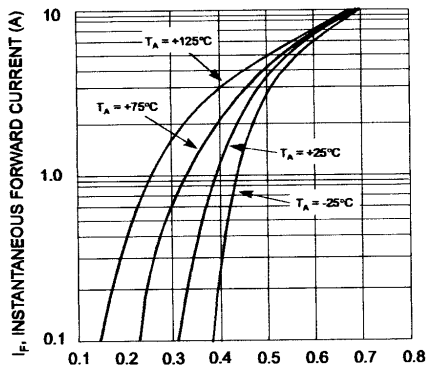

Fig. 1 Typical Forward Characteristics

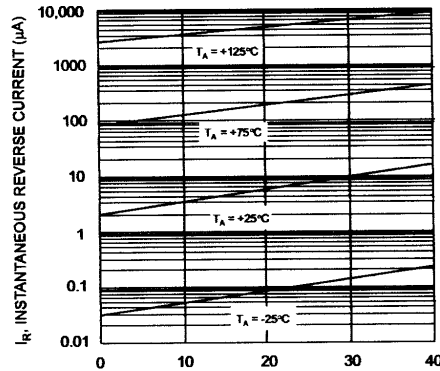

Fig. 2 Typical Reverse Characteristics

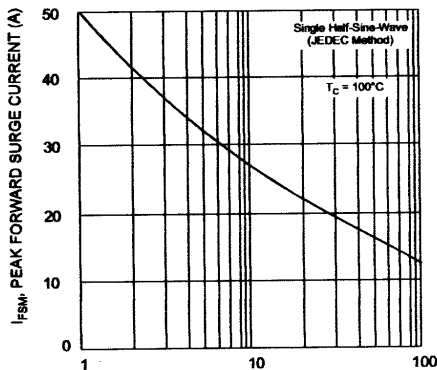

Fig. 3 Max Non-Repetitive Peak Fwd Surge Current

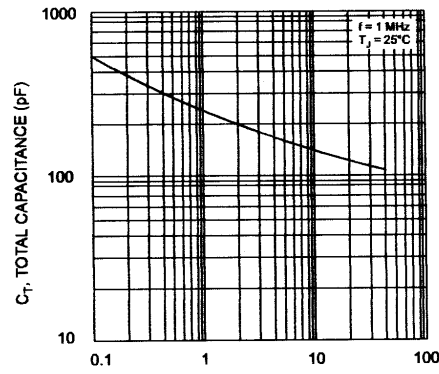
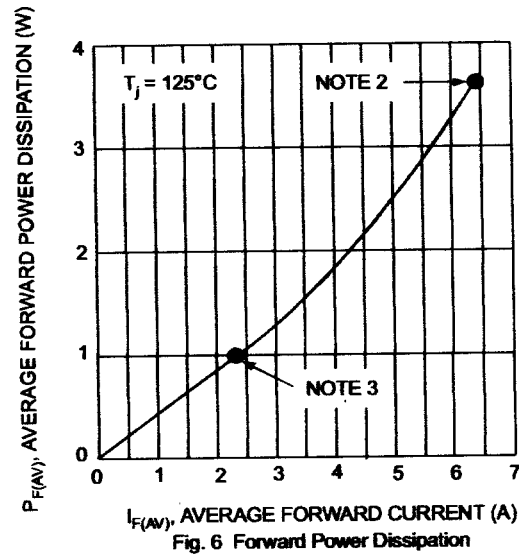
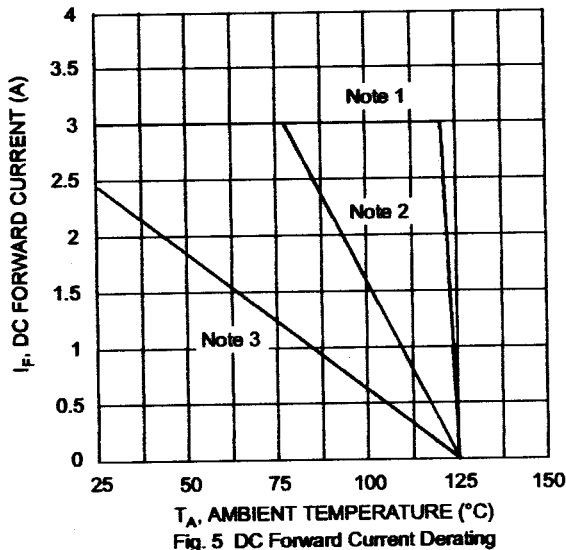
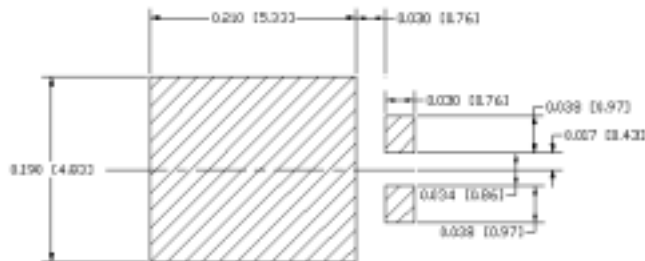

Fig. 4 Typical Capacitance vs. Reverse Voltage



- Notes:
1. $T_A = T_{\text{SOLDERING POINT}}$, $R_{\theta JS} = 3.4^\circ \text{C/W}$, $R_{\theta sa} = 0^\circ \text{C/W}$.
 2. Device mounted on GETEK substrate, 2" x 2", 2 oz. copper, double-sided, cathode pad dimensions .075" x 1.0", anode pad dimensions 0.25" x 1.0". $R_{\theta JA}$ in range of 20-40° C/W.
 3. Device mounted on FRA-4 substrate, 2" x 2", 2 oz. copper, single-sided, pad layout $R_{\theta JA}$ in range of 95 - 115° C/W.



16 mm TAPE

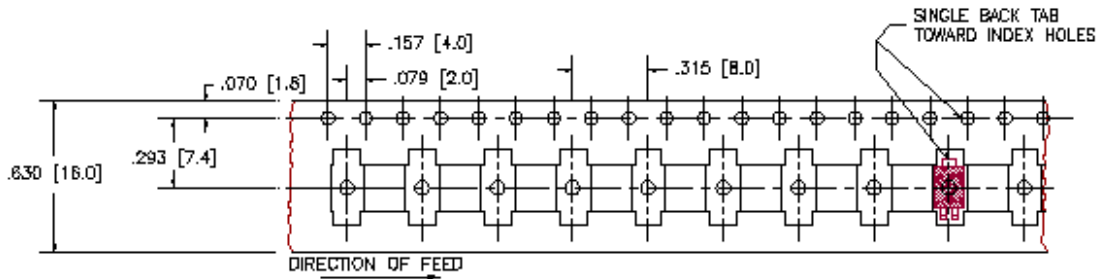

13 INCH REEL

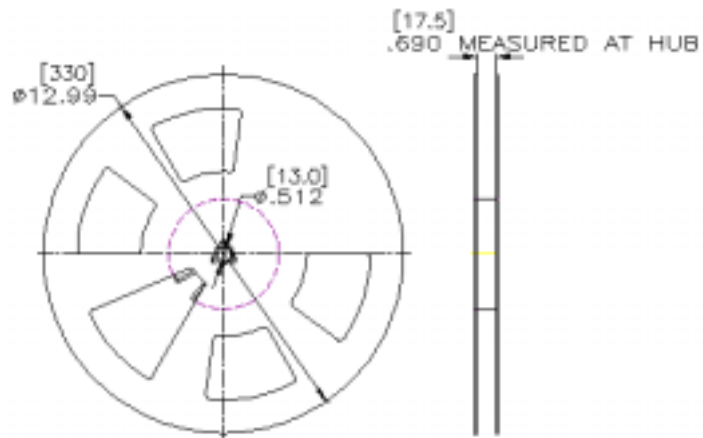

PRODUCT PRELIMINARY DATA – Information contained in this document is pre-production data, and is proprietary to Microsemi Corp. It may not be modified in any way without the express written consent of Microsemi Corp. Product referred to herein is not guaranteed to achieve preliminary or production status and product specifications, configurations, and availability may change at any time.

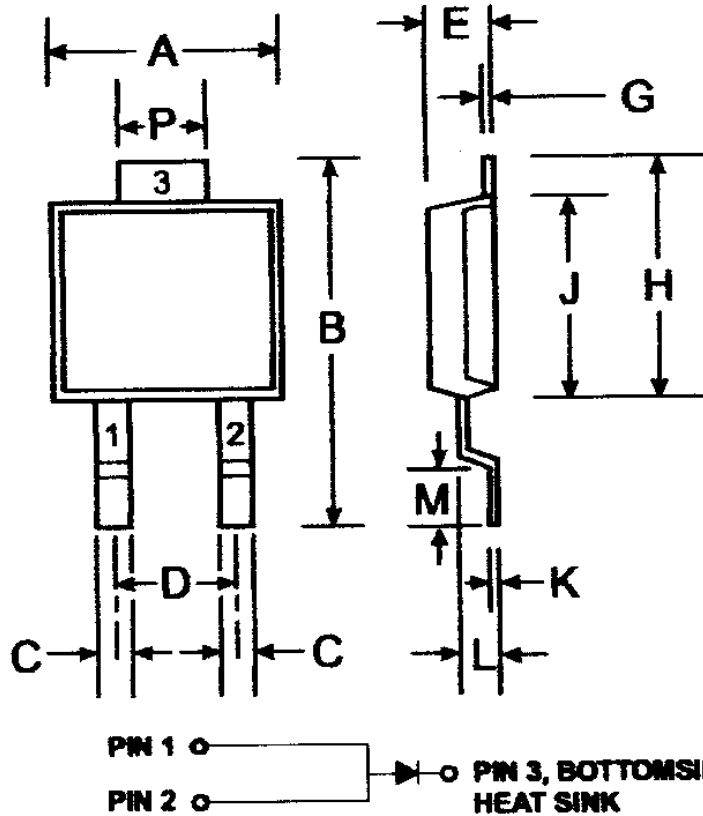

Note: Pins 1 & 2 must be electrically connected at the printed circuit board.

POWERMITE®3		
Dim	Min	Max
A	4.03	4.09
B	6.40	6.61
C	.889 NOM	
D	1.83 NOM	
E	1.10	1.14
G	.178 NOM	
H	5.01	5.17
J	4.37	4.43
K	.178 NOM	
L	.71	.77
M	.36	.46
P	1.73	1.83
All Dimensions in mm		



UPS340

3 A LOW Vf Schottky Barrier Rectifier

NOTES: