

CGA1A2C0G1E060D030BA

TDK Item Description : CGA1A2C0G1E060DT****



Equivalent C0603C0G1E060D for Automotive

Application & Main Feature

Automotive Grade (General (Up to 50V))

Series

CGA1(0603) [EIA CC0201]

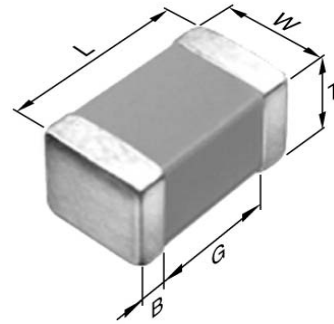

Dimensions

L 0.60mm +/-0.03mm
 W 0.30mm +/-0.03mm
 T 0.30mm +/-0.03mm
 B 0.10mm Min.
 G 0.20mm Min.

Temperature Characteristic

C0G (-55 to 125 degC 0+/-30ppm/degC)

Rated Voltage

1E (25Vdc)

Capacitance

6pF

Capacitance Tolerance

D (+/-0.5pF)

Q Factor

520 Min.

Insulation Resistance

10Gohm Min.

AEC-Q200

Yes

|Z|, ESR vs. Freq. Characteristics

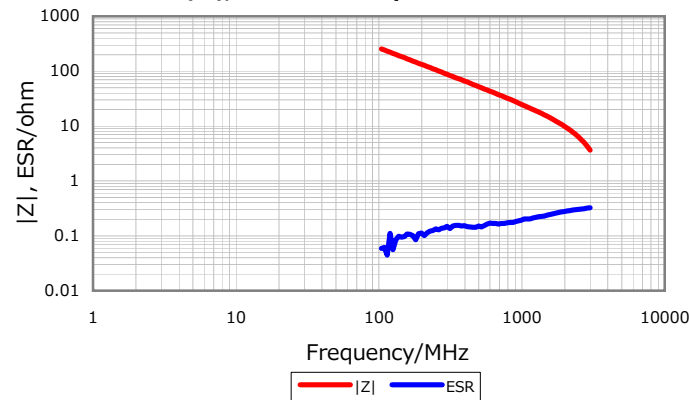

DC Bias Characteristic

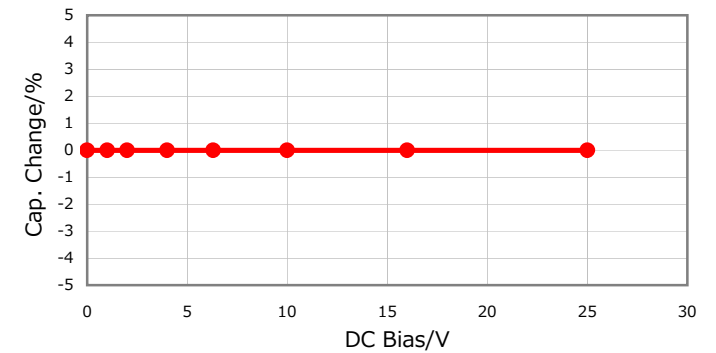

Cap. vs. Freq. Characteristic

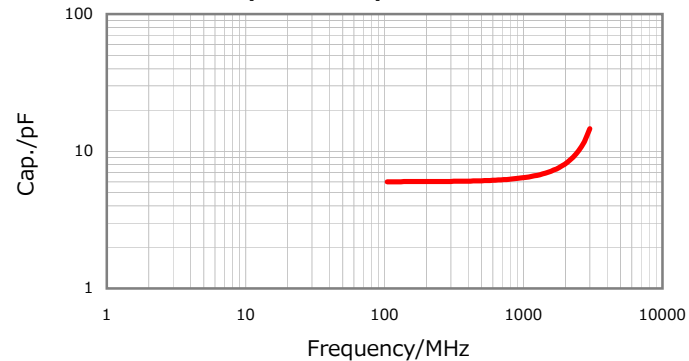

Temperature Characteristics

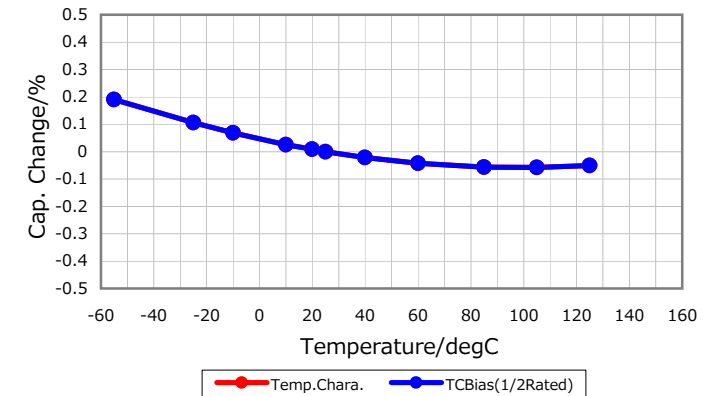

Characterization Sheet (Multilayer Ceramic Chip Capacitors)



All specifications are subject to change without notice.

January 4, 2016