

CMOS 32-BIT SINGLE CHIP MICROCONTROLLER
S5U1C31W74T1 Manual
(Software Evaluation Tool for S1C31W74)

Evaluation board/kit and Development tool important notice

1. This evaluation board/kit or development tool is designed for use for engineering evaluation, demonstration, or development purposes only. Do not use it for other purposes. It is not intended to meet the requirements of design for finished products.
2. This evaluation board/kit or development tool is intended for use by an electronics engineer and is not a consumer product. The user should use it properly and in a safe manner. Seiko Epson does not assume any responsibility or liability of any kind of damage and/or fire caused by the use of it. The user should cease to use it when any abnormal issue occurs even during proper and safe use.
3. The part used for this evaluation board/kit or development tool may be changed without any notice.

NOTICE

No part of this material may be reproduced or duplicated in any form or by any means without the written permission of Seiko Epson. Seiko Epson reserves the right to make changes to this material without notice. Seiko Epson does not assume any liability of any kind arising out of any inaccuracies contained in this material or due to its application or use in any product or circuit and, further, there is no representation that this material is applicable to products requiring high level reliability, such as, medical products. Moreover, no license to any intellectual property rights is granted by implication or otherwise, and there is no representation or warranty that anything made in accordance with this material will be free from any patent or copyright infringement of a third party. When exporting the products or technology described in this material, you should comply with the applicable export control laws and regulations and follow the procedures required by such laws and regulations. You are requested not to use, to resell, to export and/or to otherwise dispose of the products (and any technical information furnished, if any) for the development and/or manufacture of weapon of mass destruction or for other military purposes.

All brands or product names mentioned herein are trademarks and/or registered trademarks of their respective companies.

Table of Contents

1. Outline.....	1
2. How to Use SVT31W74.....	2
2.1 To Debug Software.....	2
2.2 To Perform Free-Run.....	3
Appendix A SVT31W74 Circuit Diagram	5
Appendix B Parts List.....	6
Appendix C LCD Panel Wiring Diagram	8
Revision History.....	9

1. Outline

S5U1C31W74T1 (SVT31W74: Software Evaluation Tool for S1C31W74) is an evaluation board for the Seiko Epson single-chip microcontroller S1C31W74. The parts shown below are mounted on this board.

- 1) S1C31W74 (MCU)
- 2) LCD panel
- 3) LED (one for remote-control output and three for indicators)
- 4) Piezoelectric buzzer
- 5) Five tact switches
- 6) Serial flash memory
- 7) Platform for R/F converter
- 8) Power supply regulator
- 9) Connector for debugging

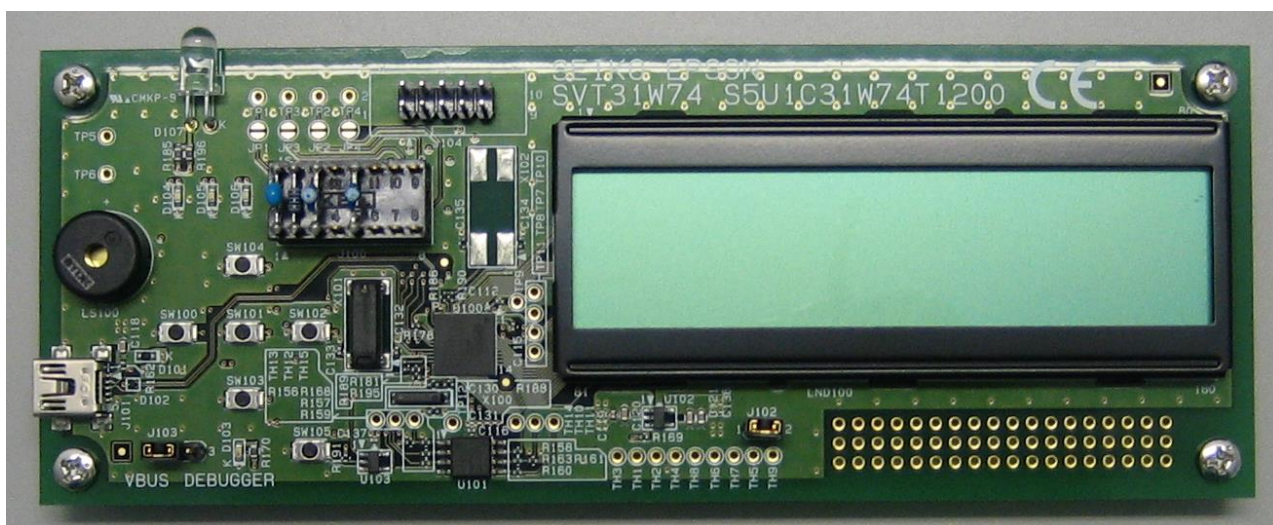

Figure 1.1 SVT31W74 External View

2. How to Use SVT31W74

2. How to Use SVT31W74

2.1 To Debug Software

- 1) Set the jumper switch (J103) on the SVT31W74 board to the DEBUGGER side.

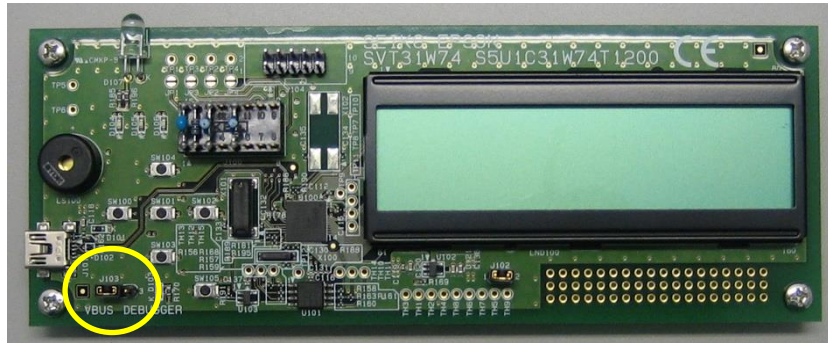

J103

Figure 2.1 SVT31W74 Jumper Switch (J103) Position

- 2) Connect the SVT31W74 board with a debug probe either IAR Systems I-jet or the SEGGER J-Link via the Seiko Epson Bridge Board Ver. 2 (S5U1C31001L1200) (*1).

(*1) The SVT31W74 boards with the following serial numbers do not support Bridge Board Ver. 2 (S5U1C3100L1200). If your SVT31W74 board has one of these serial numbers, use Bridge Board (S5U1C31001L1100) instead of Ver. 2.

<Serial No.> 1R01T5Z001 to 1R01T5Z030, 2R01T64001 to 2R01T64030, 3R01T6Z001 to 3R01T6Z010, and 1R01K68001

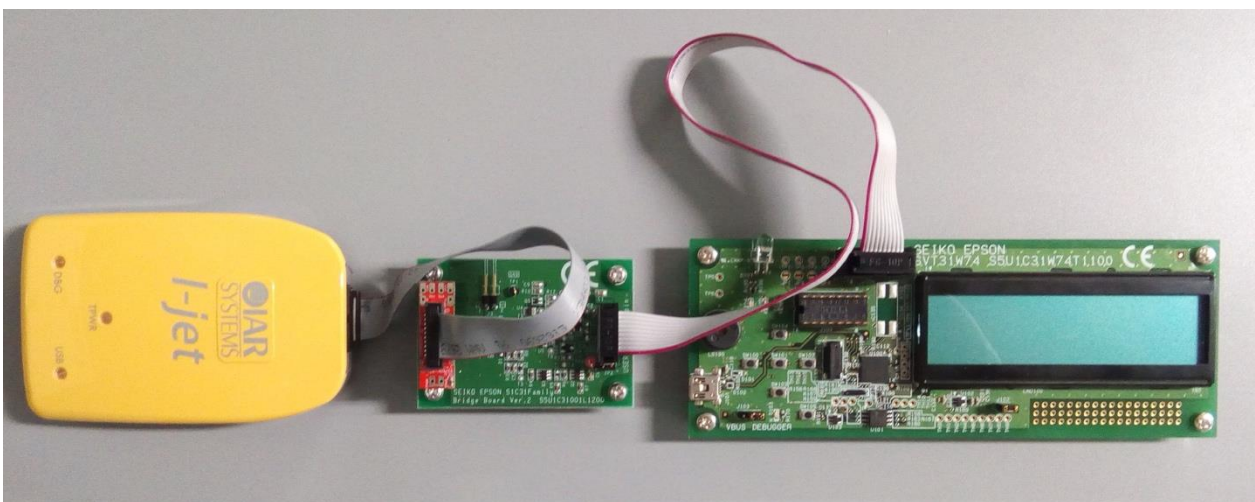

Figure 2.2 Connection Example: SVT31W74, Bridge Board Ver. 2, and Debug Probe (I-jet)

2. How to Use SVT31W74

The SVT31W74 board and the Bridge Board should be connected using the cable attached with the SVT31W74 board as shown below. The pins with a triangle mark of both the board connectors must be connected.

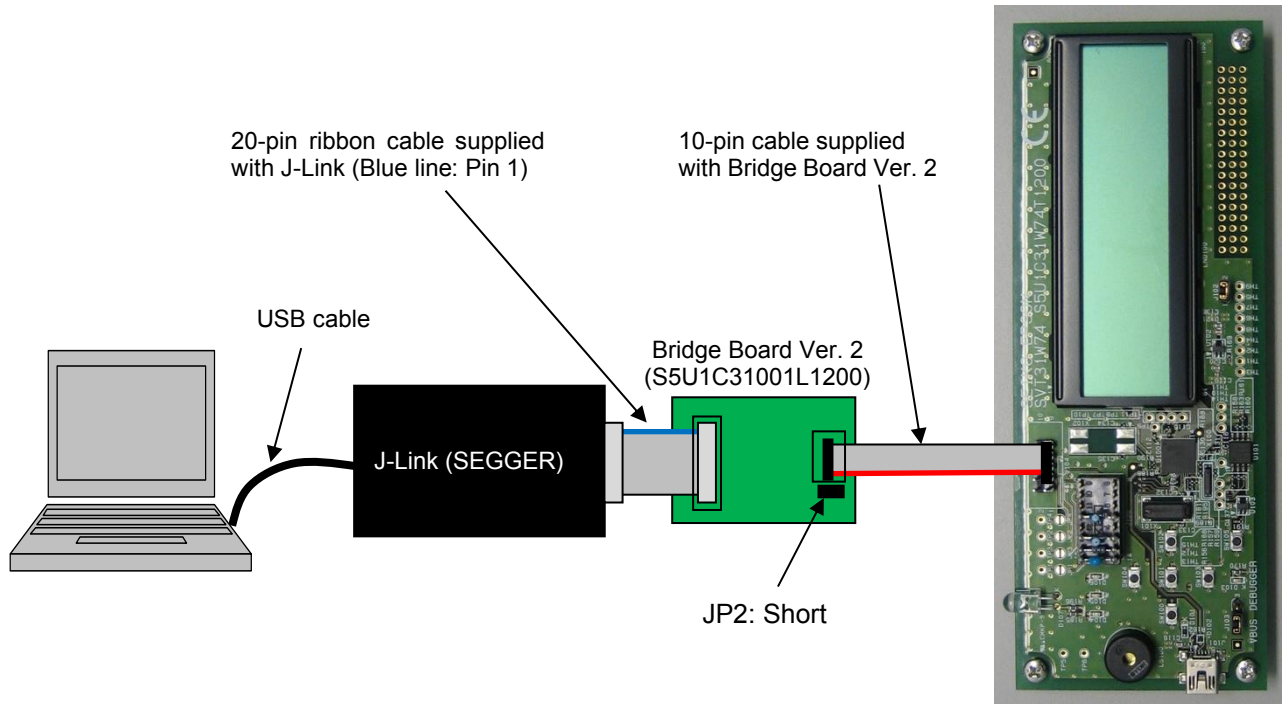

Figure 2.3 Connection Between SVT31W74 and Bridge Board

- 3) Connect the debug probe to the PC. The SVT31W74 board is controlled by the debugger on the PC via the debug probe. For installing the debugger, setting up, and using the debug system, refer to the respective manuals.

2.2 To Perform Free-Run

- 1) Set the jumper switch on the SVT31W74 board to the VBUS side.

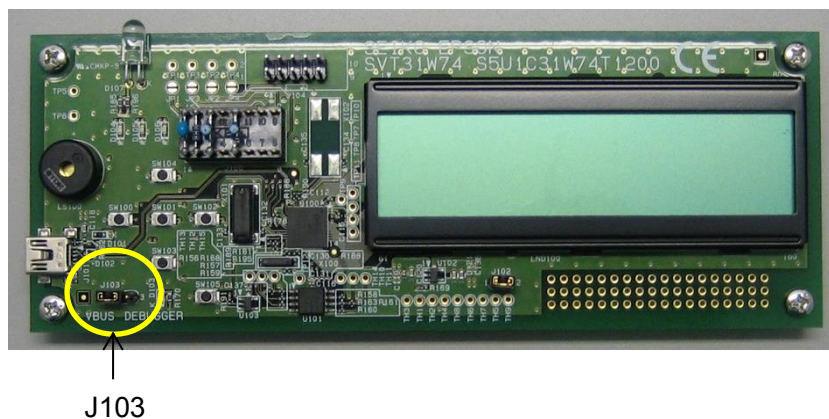

Figure 2.4 SVT31W74 Jumper Switch (J103) Position

2. How to Use SVT31W74

- 2) Connect the SVT31W74 board to the PC using a USB cable (SVT31W74 has a Mini-B connector). Please prepare a USB cable.

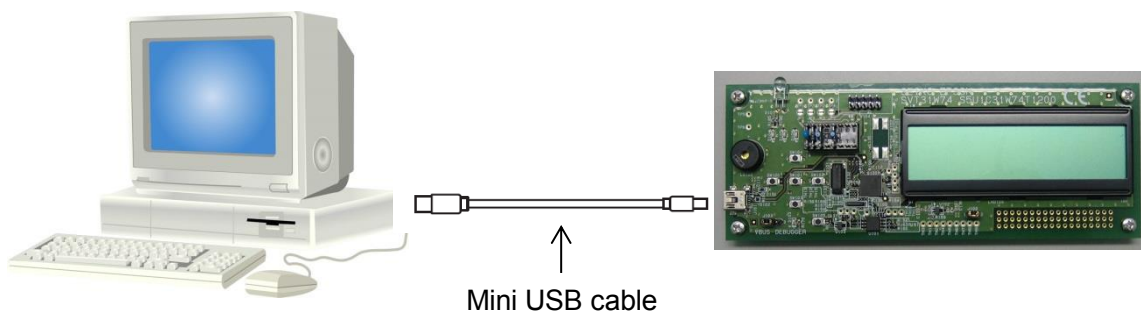
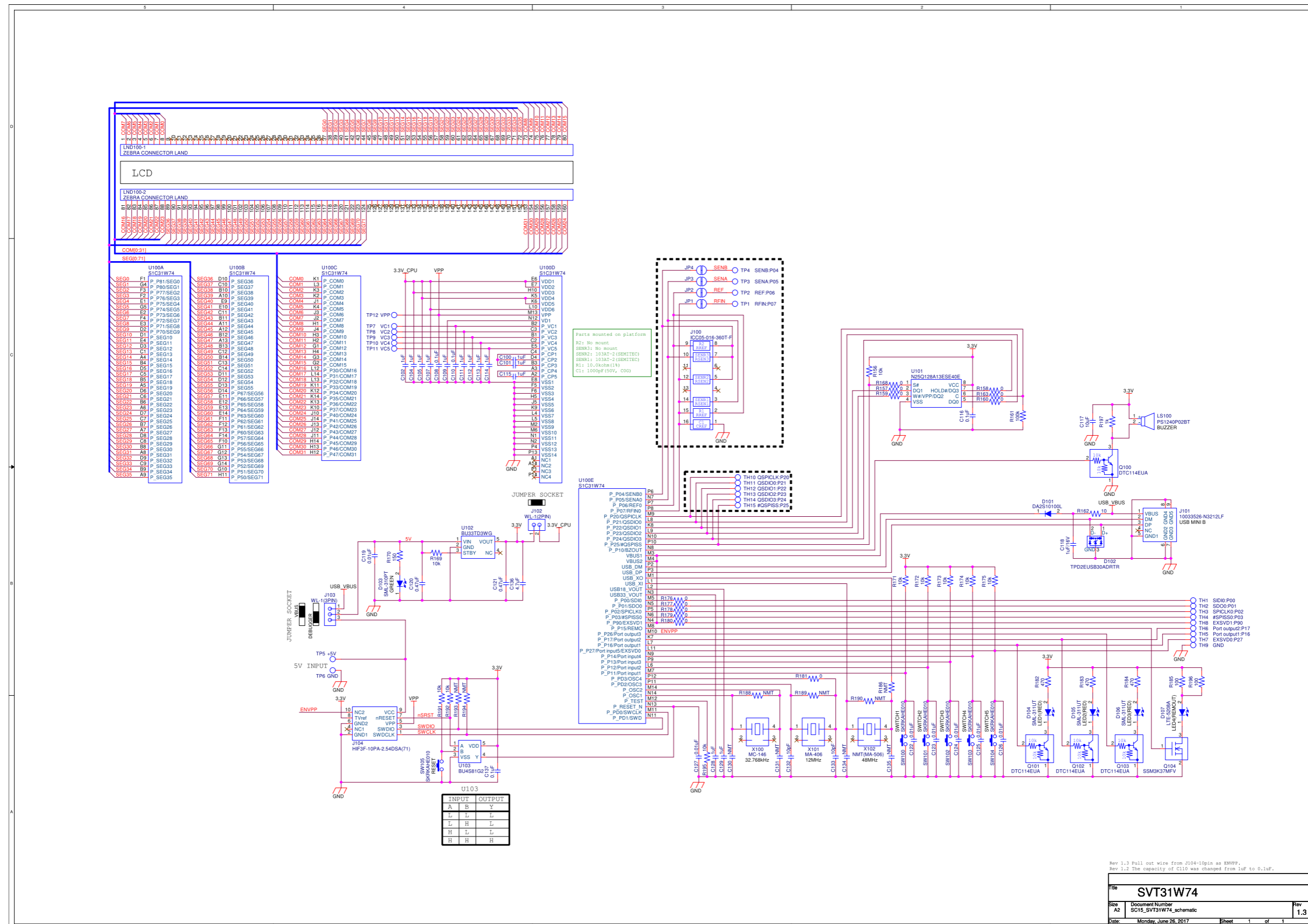

Figure 2.5 Connection Between SVT31W74 and PC

- 3) The PC supplies +5 V to the SVT31W74 board enabling the MCU on the board to start operating.

Appendix A SVT31W74 Circuit Diagram



Appendix B Parts List

Appendix B Parts List

(Mounted parts)

No.	Location	Name	Product number	Specification	Qty	Manufacture
1	C102, C104, C105, C107, C109, C111, C112, C113, C114, C128, C129	Chip capacitor	GRM155B30J105KE18D	1 μ F \pm 10%/6.3 V/B (1005)	11	muRata
2	C108, C110, C116, C137	Chip capacitor	GRM155B31E104KA87D	0.1 μ F \pm 10%/25 V/B (1005)	4	muRata
3	C117	Chip capacitor	GRM21BR61E106KA73L	10 μ F \pm 10%/25 V/X5R (2012)	1	muRata
4	C118	Chip capacitor	GRM188B31C105KA92D	1 μ F \pm 10%/16 V/B (1608)	1	muRata
5	C119, C122, C123, C124, C125, C126, C127	Chip capacitor	GRM155B11E103KA01D	0.01 μ F \pm 10%/25 V/B (1005)	7	muRata
6	C120, C121	Chip capacitor	GRM188B31E474KA75D	0.47 μ F \pm 10%/25 V/B (1608)	2	muRata
7	C130, C131, C134, C135	Chip capacitor	Unmounted	(1005)	0	
8	C132, C133	Chip capacitor	GRM1552C1H100JZ01D	10 pF \pm 5%/50 V/CH (1005)	2	muRata
9	C136	Chip capacitor	LMK107BJ475KA-T	4.7 μ F \pm 10%/10 V/X5R (1608)	1	TAIYO YUDEN
10	D101	Diode	DA2S10100L	Switching Diode	1	Panasonic
11	D102	Diode	TPD2EUSB30ADRTR	ESD protection Diode	1	TI
12	D103	Chip LED	SML-310PTT86	Green LED (1608)	1	ROHM
13	D104, D105, D106	Chip LED	SML-311UTT86	Red LED (1608)	3	ROHM
14	D107	LED	LTE-5208A	Infrared LED (ϕ 5.0/DIP)	1	Lite-On
15	J100	Socket	ICC05-016-360T-F	8-pin/2.54-mm pitch/dual row	1	KEL
16	J101	Connector	10033526-N3212LF	USB mini B	1	FCI
17	J102	Wrapping terminal	WL-1 (2 pins)	2-pin/2.54-mm pitch/single row	1	MAC8
18	J103	Wrapping terminal	WL-1 (3 pins)	3-pin/2.54-mm pitch/single row	1	MAC8
19	J104	Connector	251-8143 (W82110T3825RC)	5-pin/2.54-mm pitch/dual row, unshrouded header	1	RS components
20	LS100	Buzzer	PS1240P02BT	3 V ϕ 12.2	1	TDK
21	Q100, Q101, Q102, Q103	Transistor	DTC114EUAT106	Digital transistor (NPN)	4	ROHM
22	Q104	FET	SSM3K37MFV, L3F	MOS FET (Nch)	1	Toshiba
23	R156, R169, R171, R172, R173, R174, R175, R191, R192, R195	Chip resistor	RK73B1ETTP103J	10 k \pm 5%/0.063 W (1005)	10	KOA
24	R157, R158, R159, R160, R163, R168, R176, R177, R178, R179, R180, R181	Chip resistor	RK73Z1ETTP	0 (1005)	12	KOA
25	R161	Chip resistor	RK73B1ETTP104J	100 k \pm 5%/0.063 W (1005)	1	KOA
26	R162	Chip resistor	RK73B1ETTP100J	10 \pm 5%/0.063 W (1005)	1	KOA
27	R170	Chip resistor	RK73B1JTTP151J	150 \pm 5%/0.1 W (1608)	1	KOA
28	R182, R183, R184	Chip resistor	RK73B1ETTP471J	470 \pm 5%/0.063 W (1005)	3	KOA
29	R185, R196	Chip resistor	RK73B1JTTP101J	100 \pm 5%/0.1 W (1608)	2	KOA
30	R186, R188, R189, R190, R193, R194	Chip resistor	Unmounted	(1005)	0	
31	R197	Chip resistor	RK73B1ETTP102J	1 k \pm 5%/0.063 W (1005)	1	KOA
32	SW100, SW101, SW102, SW103, SW104, SW105	Tact switch	SKRKAHE010	Chip/momentary-on type	6	Alps
33	U100	IC	S1C31W74	MCU (VFPGA8H-181/0.5-mm pitch)	1	EPSON

Appendix B Parts List

No.	Location	Name	Product number	Specification	Qty	Manufacture
34	U101	IC	N25Q128A13ESE40E	SPI flash memory (128M bits/SOP8)	1	Micron
35	U102	IC	BU33TD3WG-TR	Regulator (LDO/3.3 V fixed/0.2 A/SSOP5)	1	ROHM
36	U103	IC	BU4S81G2-TR	CMOS logic IC (AND gate/SSOP5)	1	ROHM
37	X100	Crystal resonator	MC-146 32.768KA-AC3	32.768 kHz ±20 ppm	1	EPSON
38	X101	Crystal resonator	MA-406 12.0000M-C3	12 MHz ±50 ppm	1	EPSON
39	X102	Crystal resonator	Unmounted (MA-506 48.0000M-C0)	(48 MHz ±50 ppm)	0	EPSON
40	C100, C101, C115	Chip capacitor	GRM155B31C105KA12D	1 µF ±10%/16 V/B (1005)	3	muRata
41	R1RREF	Metal oxide film resistor	MFS1/4CC□□□□1002F	10 kΩ 1% 0.25 W	1	KOA
42	C1CREF	Ceramic capacitor	RDE5C1H102J0K1H03B	1000 pF 50 V C0G	1	muRata
43	SENR1/RSEN1, SENR2/RSEN2	Thermistor resistor	103AT-2	10.0 kΩ ±1%@25°C	2	SEMITEC

Note ! Parts are subject to change without notice.

(Installed parts)

No.	Location	Name	Product number	Specification	Qty	Manufacture
1	---	LCD	OPTO0569NG	32 com x 128 seg	1	
2	---	Platform	DIS12-016-403	8-pin/2.54-mm pitch/dual row	1	KEL
3	---	Jumper pin	JS-1	2-pin/2.54-mm pitch/single row	2	MAC8
4	---	Screw	FB-0305N	M = 3.0 mm, L = 5.0 mm	4	Wilco
5	---	Spacer	ASB-309.5E	M = 3.0 mm, L = 9.5 mm	4	Hirosugi-Keiki

Note ! Parts are subject to change without notice.

Appendix C LCD Panel Wiring Diagram

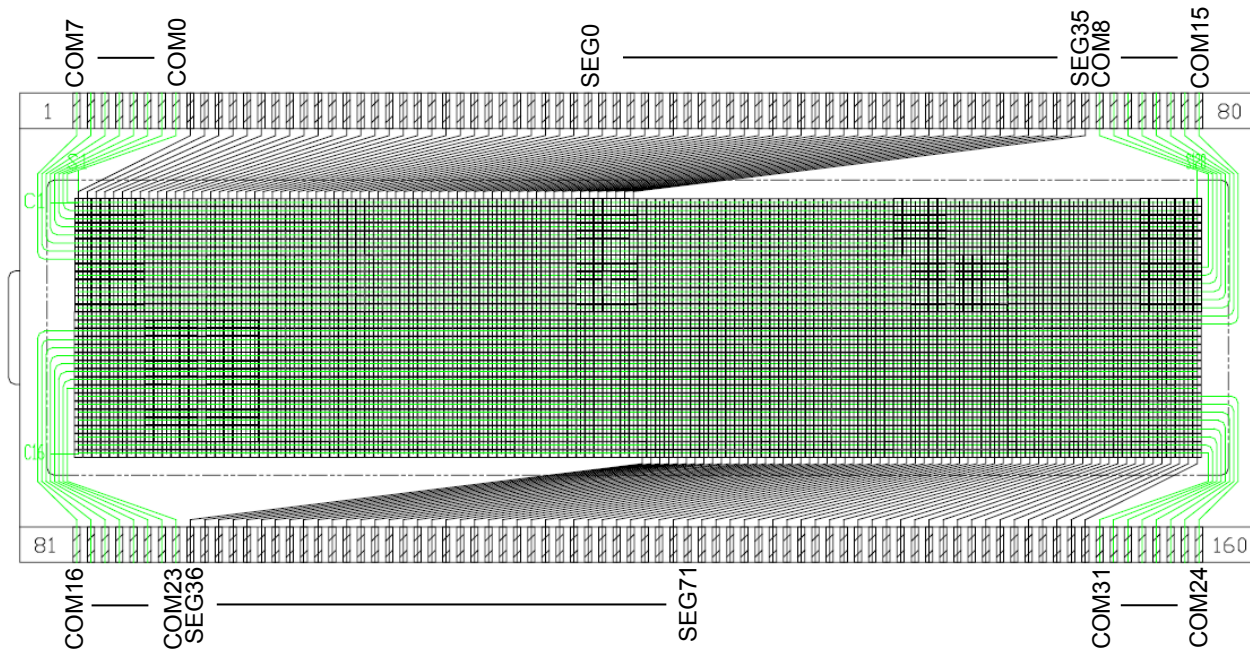

Revision History

Attachment-1

Rev. No.	Date	Page	Category	Contents
Rev 1.0	2016/05/27	All	New	New establishment
Rev. 1.1	2017/06/27	P2, P3, P5, P11	Revision	Modified to support ENVPP signal and Bridge Board Ver. 2
		P6	Revision	Modified the table (C110 was changed from 1 μF to 0.1 μF).

AMERICA

EPSON ELECTRONICS AMERICA, INC.

214 Devcon Drive,
San Jose, CA 95112, USA
Phone: +1-800-228-3964 FAX: +1-408-922-0238

EUROPE

EPSON EUROPE ELECTRONICS GmbH

Riesstrasse 15, 80992 Munich,
GERMANY
Phone: +49-89-14005-0 FAX: +49-89-14005-110

ASIA

EPSON (CHINA) CO., LTD.

4th Floor, Tower 1 of China Central Place, 81 Jianguo Road, Chaoyang
District, Beijing 100025 China
Phone: +86-10-8522-1199 FAX: +86-10-8522-1120

SHANGHAI BRANCH

Room 1701 & 1704, 17 Floor, Greenland Center II,
562 Dong An Road, Xu Hui District, Shanghai, CHINA
Phone: +86-21-5330-4888 FAX: +86-21-5423-4677

SHENZHEN BRANCH

Room 804-805, 8 Floor, Tower 2, Ali Center, No.3331
Keyuan South RD (Shenzhen bay), Nanshan District, Shenzhen
518054, CHINA
Phone: +86-10-3299-0588 FAX: +86-10-3299-0560

EPSON TAIWAN TECHNOLOGY & TRADING LTD.

14F, No. 7, Song Ren Road,
Taipei 110, TAIWAN
Phone: +886-2-8786-6688 FAX: +886-2-8786-6660

EPSON SINGAPORE PTE., LTD.

1 HarbourFront Place,
#03-02 HarbourFront Tower One, Singapore 098633
Phone: +65-6586-5500 FAX: +65-6271-3182

SEIKO EPSON CORP.**KOREA OFFICE**

19F, KLI 63 Bldg., 60 Yoido-dong,
Youngdeungpo-Ku, Seoul 150-763, KOREA
Phone: +82-2-784-6027 FAX: +82-2-767-3677

SEIKO EPSON CORP.**SALES & MARKETING DIVISION****Device Sales & Marketing Department**

421-8, Hino, Hino-shi, Tokyo 191-8501, JAPAN
Phone: +81-42-587-5816 FAX: +81-42-587-5116