

## 74ALVC16601

### Low Voltage 18-Bit Universal Bus Transceivers with 3.6V Tolerant Inputs and Outputs

#### General Description

The ALVC16601 is an 18-bit universal bus transceiver which combines D-type latches and D-type flip-flops to allow data flow in transparent, latched, and clocked modes.

Data flow in each direction is controlled by output-enable ( $\overline{OEAB}$  and  $\overline{OEBA}$ ), latch-enable (LEAB and LEBA), and clock (CLKAB and CLKBA) inputs. The clock can be controlled by the clock-enable (CLKENAB and CLKENBA) inputs. For A-to-B data flow, the device operates in the transparent mode when LEAB is HIGH. When LEAB is LOW, the A data is latched if CLKAB is held at a HIGH-to-LOW logic level. If LEAB is LOW, the A bus data is stored in the latch/flip-flop on the LOW-to-HIGH transition of CLKAB. When  $\overline{OEAB}$  is LOW, the outputs are active. When  $\overline{OEAB}$  is HIGH, the outputs are in the high-impedance state.

Data flow for B to A is similar to that of A to B but uses  $\overline{OEBA}$ , LEBA, CLKBA and CLKENBA.

The ALVC16601 is designed for low voltage (1.65V to 3.6V)  $V_{CC}$  applications with I/O capability up to 3.6V.

The ALVC16601 is fabricated with an advanced CMOS technology to achieve high speed operation while maintaining low CMOS power dissipation.

#### Features

- 1.65V–3.6V  $V_{CC}$  supply operation
- 3.6V tolerant inputs and outputs
- $t_{PD}$  (A to B, B to A)
  - 3.4 ns max for 3.0V to 3.6V  $V_{CC}$
  - 4.0 ns max for 2.3V to 2.7V  $V_{CC}$
  - 7.0 ns max for 1.65V 1.95V  $V_{CC}$
- Power-down high impedance inputs and outputs
- Supports live insertion/withdrawal (Note 1)
- Uses patented noise/EMI reduction circuitry
- Latchup conforms to JEDEC JED78
- ESD performance:
  - Human body model > 2000V
  - Machine model >200V
- Also packaged in plastic Fine-Pitch Ball Grid Array (FBGA) (Preliminary)

**Note 1:** To ensure the high-impedance state during power up or power down,  $\overline{OE}$  should be tied to  $V_{CC}$  through a pull-up resistor; the minimum value of the resistor is determined by the current-sourcing capability of the driver.

#### Ordering Code:

Order Number	Package Number	Package Description
74ALVC16601GX (Note 2)	BGA54A (Preliminary)	54-Ball Fine-Pitch Ball Grid Array (FBGA), JEDEC MO-205, 5.5mm Wide [TAPE and REEL]
74ALVC16601MTD (Note 3)	MTD56	56-Lead Thin Shrink Small Outline Package (TSSOP), JEDEC MO-153, 6.1mm Wide

**Note 2:** BGA package available in Tape and Reel only.

**Note 3:** Devices also available in Tape and Reel. Specify by appending the suffix letter "X" to the ordering code.

### Connection Diagrams

Pin Assignment for TSSOP

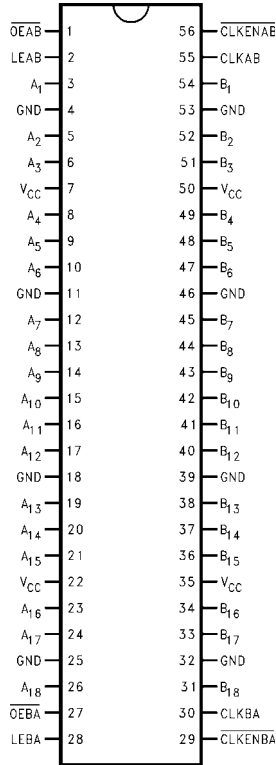

Pin Assignment for FBGA

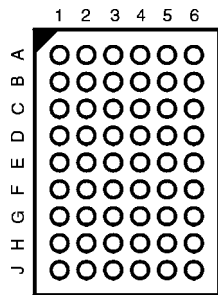

(Top Thru View)

### Pin Descriptions

Pin Names	Description
OEAB, OEBA	Output Enable Inputs (Active LOW)
LEAB, LEBA	Latch Enable Inputs
CLKAB, CLKBA	Clock Inputs
CLKENAB, CLKENBA	Clock Enable Inputs
A <sub>1</sub> -A <sub>18</sub>	Side A Inputs or 3-STATE Outputs
B <sub>1</sub> -B <sub>18</sub>	Side B Inputs or 3-STATE Outputs

### FBGA Pin Assignments

	1	2	3	4	5	6
<b>A</b>	A <sub>2</sub>	A <sub>1</sub>	OEAB	CLKENAB	B <sub>1</sub>	B <sub>2</sub>
<b>B</b>	A <sub>4</sub>	A <sub>3</sub>	LEAB	CLKAB	B <sub>3</sub>	B <sub>4</sub>
<b>C</b>	A <sub>6</sub>	A <sub>5</sub>	V <sub>CC</sub>	V <sub>CC</sub>	B <sub>5</sub>	B <sub>6</sub>
<b>D</b>	A <sub>8</sub>	A <sub>7</sub>	GND	GND	B <sub>7</sub>	B <sub>8</sub>
<b>E</b>	A <sub>10</sub>	A <sub>9</sub>	GND	GND	B <sub>9</sub>	B <sub>10</sub>
<b>F</b>	A <sub>12</sub>	A <sub>11</sub>	GND	GND	B <sub>11</sub>	B <sub>12</sub>
<b>G</b>	A <sub>14</sub>	A <sub>13</sub>	V <sub>CC</sub>	V <sub>CC</sub>	B <sub>13</sub>	B <sub>14</sub>
<b>H</b>	A <sub>16</sub>	A <sub>15</sub>	OEBA	CLKBA	B <sub>15</sub>	B <sub>16</sub>
<b>J</b>	A <sub>17</sub>	A <sub>18</sub>	LEBA	CLKENBA	B <sub>18</sub>	B <sub>17</sub>

### Truth Table

(Note 4)

Inputs					Outputs
CLKENAB	OEAB	LEAB	CLKAB	A <sub>n</sub>	B <sub>n</sub>
X	H	X	X	X	Z
X	L	H	X	L	L
X	L	H	X	H	H
H	L	L	X	X	B <sub>0</sub> (Note 5)
H	L	L	X	X	B <sub>0</sub> (Note 5)
L	L	L	↑	L	L
L	L	L	↑	H	H
L	L	L	L	X	B <sub>0</sub> (Note 5)
L	L	L	H	X	B <sub>0</sub> (Note 6)

H = HIGH Voltage Level  
 L = LOW Voltage Level  
 X = Immaterial (HIGH or LOW, inputs may not float)  
 Z = High Impedance

**Note 4:** A-to-B data flow is shown; B-to-A flow is similar but uses OEBA, LEBA, CLKBA, and CLKENBA.

**Note 5:** Output level before the indicated steady-state input conditions were established.

**Note 6:** Output level before the indicated steady-state input conditions were established, provided that CLKAB was HIGH before LEAB went LOW.

### Logic Diagram

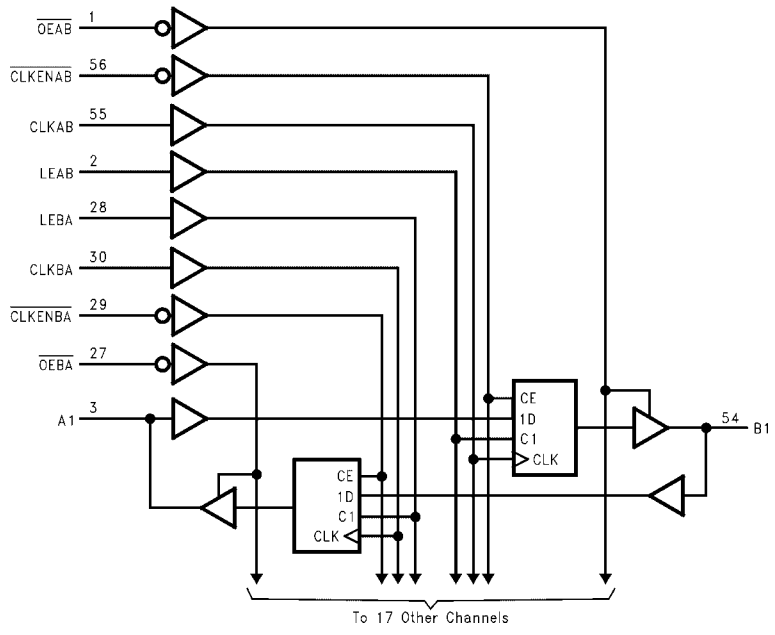

**Absolute Maximum Ratings** (Note 7)

Supply Voltage ( $V_{CC}$ )	-0.5V to +4.6V
DC Input Voltage ( $V_I$ )	-0.5V to 4.6V
Output Voltage ( $V_O$ ) (Note 8)	-0.5V to $V_{CC}$ + 0.5V
DC Input Diode Current ( $I_{IK}$ )	
$V_I < 0V$	-50 mA
DC Output Diode Current ( $I_{OK}$ )	
$V_O < 0V$	-50 mA
DC Output Source/Sink Current ( $I_{OH}/I_{OL}$ )	$\pm 50$ mA
DC $V_{CC}$ or GND Current per Supply Pin ( $I_{CC}$ or GND)	$\pm 100$ mA
Storage Temperature Range ( $T_{STG}$ )	-65°C to +150°C

**Recommended Operating Conditions** (Note 9)

Power Supply	
Operating	1.65V to 3.6V
Input Voltage ( $V_I$ )	0V to $V_{CC}$
Output Voltage ( $V_O$ )	0V to $V_{CC}$
Free Air Operating Temperature ( $T_A$ )	-40°C to +85°C
Minimum Input Edge Rate ( $\Delta t/\Delta V$ )	
$V_{IN} = 0.8V$ to 2.0V, $V_{CC} = 3.0V$	10 ns/V

**Note 7:** The Absolute Maximum Ratings are those values beyond which the safety of the device cannot be guaranteed. The device should not be operated at these limits. The parametric values defined in the Electrical Characteristics tables are not guaranteed at the Absolute Maximum Ratings. The "Recommended Operating Conditions" table will define the conditions for actual device operation.

**Note 8:**  $I_O$  Absolute Maximum Rating must be observed.

**Note 9:** Floating or unused inputs must be held HIGH or LOW.

**DC Electrical Characteristics**

Symbol	Parameter	Conditions	$V_{CC}$ (V)	Min	Max	Units
$V_{IH}$	HIGH Level Input Voltage		1.65 - 1.95 2.3 - 2.7 2.7 - 3.6	$0.65 \times V_{CC}$ 1.7 2.0		V
$V_{IL}$	LOW Level Input Voltage		1.65 - 1.95 2.3 - 2.7 2.7 - 3.6		$0.35 \times V_{CC}$ 0.7 0.8	V
$V_{OH}$	HIGH Level Output Voltage	$I_{OH} = -100 \mu A$ $I_{OH} = -4 \text{ mA}$ $I_{OH} = -6 \text{ mA}$ $I_{OH} = -12 \text{ mA}$  $I_{OH} = -24 \text{ mA}$	1.65 - 3.6 1.65 2.3 2.7 3.0 3.0	$V_{CC} - 0.2$ 1.2 2 1.7 2.2 2.4		V
$V_{OL}$	LOW Level Output Voltage	$I_{OL} = 100 \mu A$ $I_{OL} = 4 \text{ mA}$ $I_{OL} = 6 \text{ mA}$ $I_{OL} = 12 \text{ mA}$  $I_{OL} = 24 \text{ mA}$	1.65 - 3.6 1.65 2.3 2.3 2.7 3		0.2 0.45 0.4 0.7 0.4 0.55	V
$I_I$	Input Leakage Current	$0 \leq V_I \leq 3.6V$	3.6		$\pm 5.0$	$\mu A$
$I_{OZ}$	3-STATE Output Leakage	$0 \leq V_O \leq 3.6V$	3.6		$\pm 10$	$\mu A$
$I_{CC}$	Quiescent Supply Current	$V_I = V_{CC}$ or GND, $I_O = 0$	3.6		40	$\mu A$
$\Delta I_{CC}$	Increase in $I_{CC}$ per Input	$V_{IH} = V_{CC} - 0.6V$	3 - 3.6		750	$\mu A$

AC Electrical Characteristics										
Symbol	Parameter	$T_A = -40^{\circ}\text{C}$ to $+85^{\circ}\text{C}$ , $R_L = 500\Omega$								Units
		$C_L = 50\text{ pF}$				$C_L = 30\text{ pF}$				
		$V_{CC} = 3.3\text{V} \pm 0.3\text{V}$		$V_{CC} = 2.7\text{V}$		$V_{CC} = 2.5\text{V} \pm 0.2\text{V}$		$V_{CC} = 1.8\text{V} \pm 0.15\text{V}$		
		Min	Max	Min	Max	Min	Max	Min	Max	
$f_{\text{MAX}}$	Maximum Clock Frequency	250		200		200		100		ns
$t_{\text{PHL}}$ , $t_{\text{PLH}}$	Propagation Delay Bus to Bus	1.3	3.4	1.5	4.0	1.0	3.5	1.5	7.0	ns
$t_{\text{PHL}}$ , $t_{\text{PLH}}$	Propagation Delay CLK to Bus	1.3	4.0	1.5	4.9	1.0	4.4	1.5	8.8	ns
$t_{\text{PHL}}$ , $t_{\text{PLH}}$	Propagation Delay LE to Bus	1.3	4.0	1.5	4.9	1.0	4.4	1.5	8.8	ns
$t_{\text{PZL}}$ , $t_{\text{PZH}}$	Output Enable Time	1.3	4.3	1.5	5.4	1.0	4.9	1.5	9.8	ns
$t_{\text{PLZ}}$ , $t_{\text{PHZ}}$	Output Disable Time	1.3	4.2	1.5	4.7	1.0	4.2	1.5	7.6	ns
$t_W$	Pulse Width	1.5		1.5		1.5		4.0		ns
$t_S$	Setup Time	1.5		1.5		1.5		2.5		ns
$t_H$	Hold Time	1.0		1.0		1.0		1.0		ns
Capacitance										
Symbol	Parameter		Conditions		$T_A = +25^{\circ}\text{C}$		Units			
					$V_{CC}$	Typical				
$C_{\text{IN}}$	Input Capacitance		$V_I = 0\text{V}$ or $V_{CC}$		3.3	6	pF			
$C_{\text{OUT}}$	Output Capacitance		$V_I = 0\text{V}$ or $V_{CC}$		3.3	7	pF			
$C_{\text{PD}}$	Power Dissipation Capacitance	Outputs Enabled	$f = 10\text{ MHz}$ , $C_L = 50\text{ pF}$		3.3	20	pF			
					2.5	20				

AC Loading and Waveforms

TABLE 1. Values for Figure 1

TEST	SWITCH
$t_{PLH}$ , $t_{PHL}$	Open
$t_{PZL}$ , $t_{PLZ}$	$V_L$
$t_{PZH}$ , $t_{PHZ}$	GND

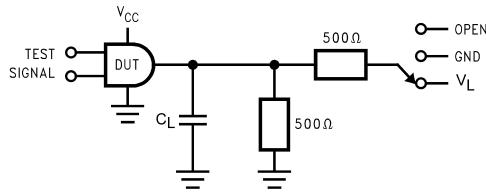

FIGURE 1. AC Test Circuit

TABLE 2. Variable Matrix  
(Input Characteristics:  $f = 1\text{MHz}$ ;  $t_r = t_f = 2\text{ns}$ ;  $Z_0 = 50\Omega$ )

Symbol	$V_{CC}$			
	$3.3\text{V} \pm 0.3\text{V}$	$2.7\text{V}$	$2.5\text{V} \pm 0.2\text{V}$	$1.8\text{V} \pm 0.15\text{V}$
$V_{mi}$	1.5V	1.5V	$V_{CC}/2$	$V_{CC}/2$
$V_{mo}$	1.5V	1.5V	$V_{CC}/2$	$V_{CC}/2$
$V_X$	$V_{OL} + 0.3\text{V}$	$V_{OL} + 0.3\text{V}$	$V_{OL} + 0.15\text{V}$	$V_{OL} + 0.15\text{V}$
$V_Y$	$V_{OH} - 0.3\text{V}$	$V_{OH} - 0.3\text{V}$	$V_{OH} - 0.15\text{V}$	$V_{OH} - 0.15\text{V}$
$V_L$	6V	6V	$V_{CC} \times 2$	$V_{CC} \times 2$

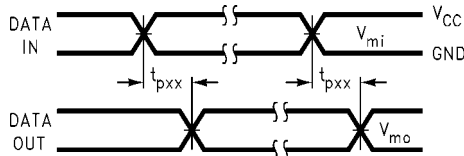

FIGURE 2. Waveform for Inverting and Non-inverting Functions

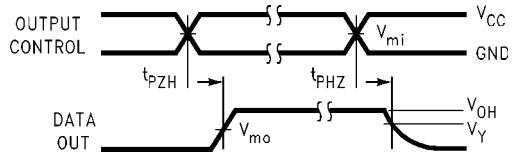

FIGURE 3. 3-STATE Output High Enable and Disable Times for Low Voltage Logic

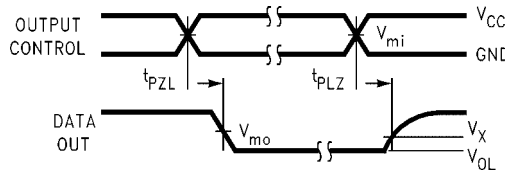

FIGURE 4. 3-STATE Output Low Enable and Disable Times for Low Voltage Logic

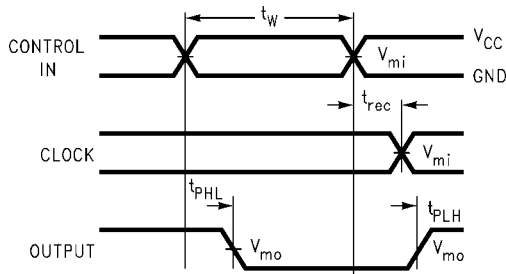

FIGURE 5. Propagation Delay, Pulse Width and  $t_{rec}$  Waveforms

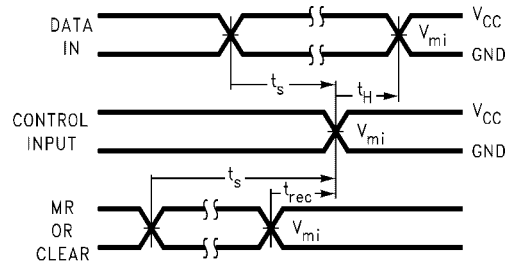
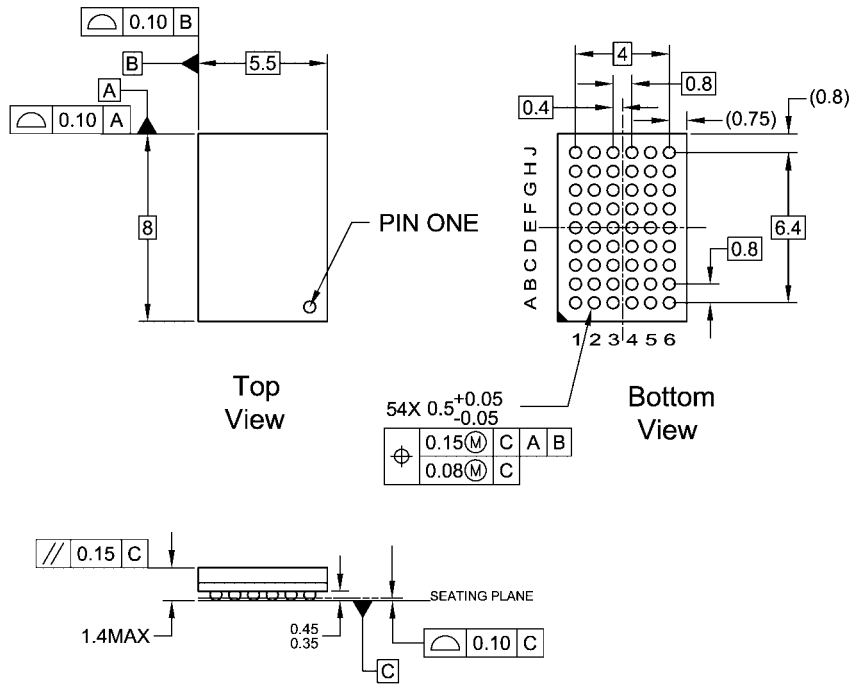

FIGURE 6. Setup Time, Hold Time and Recovery Time for Low Voltage Logic

**Physical Dimensions** inches (millimeters) unless otherwise noted



NOTES:

- A. THIS PACKAGE CONFORMS TO JEDEC M0-205
- B. ALL DIMENSIONS IN MILLIMETERS
- C. LAND PATTERN RECOMMENDATION: NSMD (Non Solder Mask Defined)  
.35MM DIA PADS WITH A SOLDERMASK OPENING OF .45MM CONCENTRIC TO PADS
- D. DRAWING CONFORMS TO ASME Y14.5M-1994

BGA54ArevD

**54-Ball Fine-Pitch Ball Grid Array (FBGA), JEDEC M0-205, 5.5mm Wide  
Package Number BGA54A  
(Preliminary)**

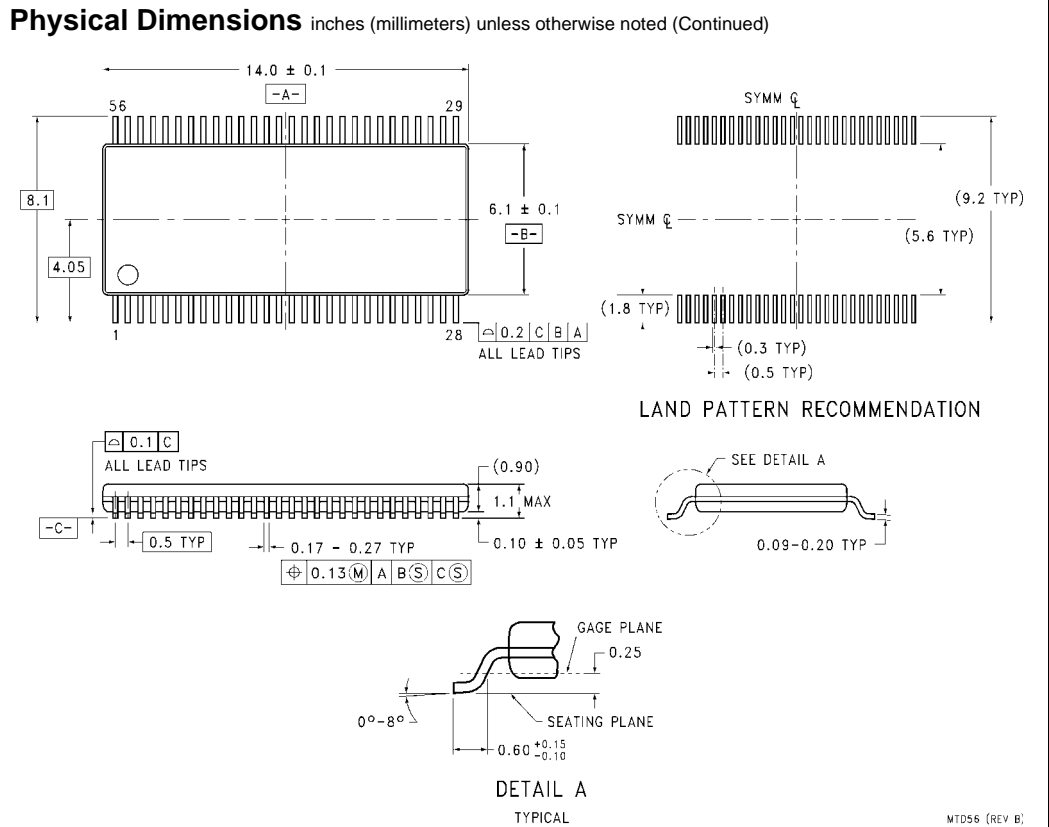

56-Lead Thin Shrink Small Outline Package (TSSOP), JEDEC MO-153, 6.1mm Wide Package Number MTD56

Fairchild does not assume any responsibility for use of any circuitry described, no circuit patent licenses are implied and Fairchild reserves the right at any time without notice to change said circuitry and specifications.

**LIFE SUPPORT POLICY**

FAIRCHILD'S PRODUCTS ARE NOT AUTHORIZED FOR USE AS CRITICAL COMPONENTS IN LIFE SUPPORT DEVICES OR SYSTEMS WITHOUT THE EXPRESS WRITTEN APPROVAL OF THE PRESIDENT OF FAIRCHILD SEMICONDUCTOR CORPORATION. As used herein:

1. Life support devices or systems are devices or systems which, (a) are intended for surgical implant into the body, or (b) support or sustain life, and (c) whose failure to perform when properly used in accordance with instructions for use provided in the labeling, can be reasonably expected to result in a significant injury to the user.
2. A critical component in any component of a life support device or system whose failure to perform can be reasonably expected to cause the failure of the life support device or system, or to affect its safety or effectiveness.

[www.fairchildsemi.com](http://www.fairchildsemi.com)