

SPECIFICATION

Part No.	:	FXP40.07.0085A
Product Name	:	Quad-Band GSM850/GSM900/DCS/PCS Flexible PCB Antenna
Features	:	824-960/1710-1990MHz Application bands 1.37 dBi Peak Gain 42.6*12.1*0.15mm Tiny Dimension IPEX MHFI (U.FL Compatible) 85mm 1.13mm cable RoHS Compliant



1. Introduction

The FXP40 is a super small monopole ultra low profile antenna for GSM850/GSM900/DCS/PCS quad bands. The FXP40 has a peak gain of 1.3dBi and efficiencies of 56%.

It is made from poly-flexible material, has a tiny form factor (42.6mm*12.1mm*0.15mm) and has double-sided 3M tape for easy “peel and stick” mounting.

Across the bands and is designed to be mounted directly onto a plastic. It is an ideal choice for any device maker that needs to keep manufacturing costs down over the lifetime of a product.

The cables length can be customizable for customers.

2. Specification

ELECTRICAL				
	GSM850	GSM900	DCS	PCS
Frequency (MHz)	824~896	880~960	1710~1880	1850~1990
Max Return Loss (dB)	<-5	<-5	<-5	<-3
Peak Gain (dBi)	-3.83	-3.25	1.37	1.03
Efficiency (%)	24	26	51	56
Average Gain (dB)	-6.22	-6.57	-2.87	-2.49
Radiation Properties	Omni-directional			
Max Input Power (Watts)	5			
Polarization	Linear			
Impedance (Ohms)	50 Ohms			
MECHANICAL				
Dimensions (mm)	46.2*12.1*0.15 mm			
Material	Flexible Polymer			
Connector and Cable	IPEX MHFI (U.FL Compatible) and 1.13 mm mini coax			
Weight	88g			
ENVIRONMENTAL RATINGS				
Operation Temperature	-40°C to 85°C			
Storage Temperature	-40°C to 85°C			
Relative Humidity	40% to 95%			
RoHs Compliant	Yes			

*All results were measured with 85mm length 1.13mm coaxial cable and on 2mm thickness ABS base.

3. Antenna Characteristics

3.1. Return Loss

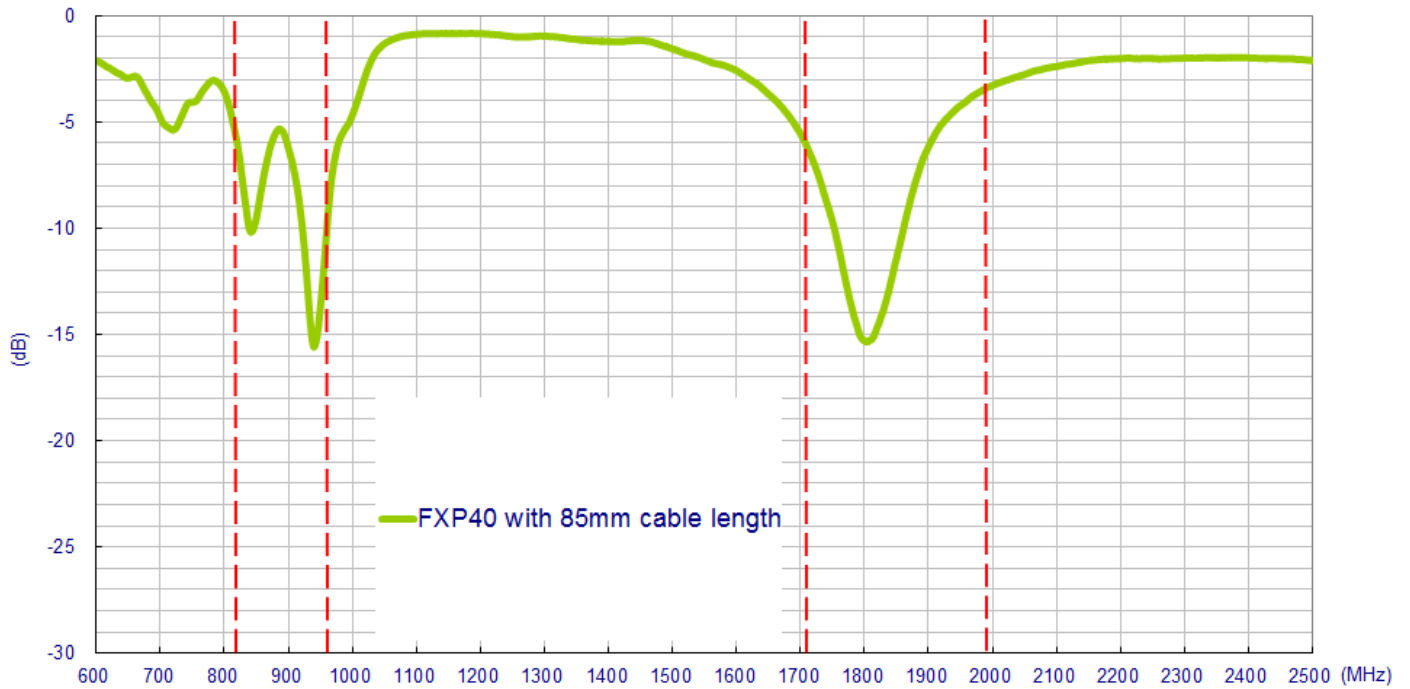

3.2. Peak Gain

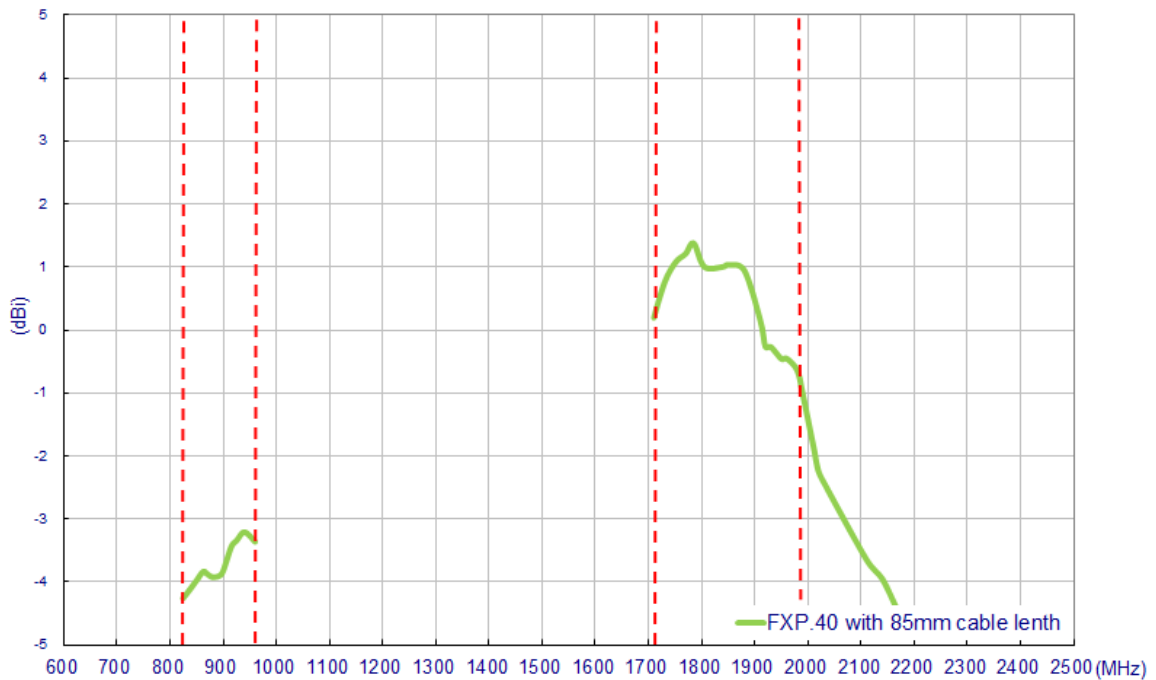

3.3. Efficiency

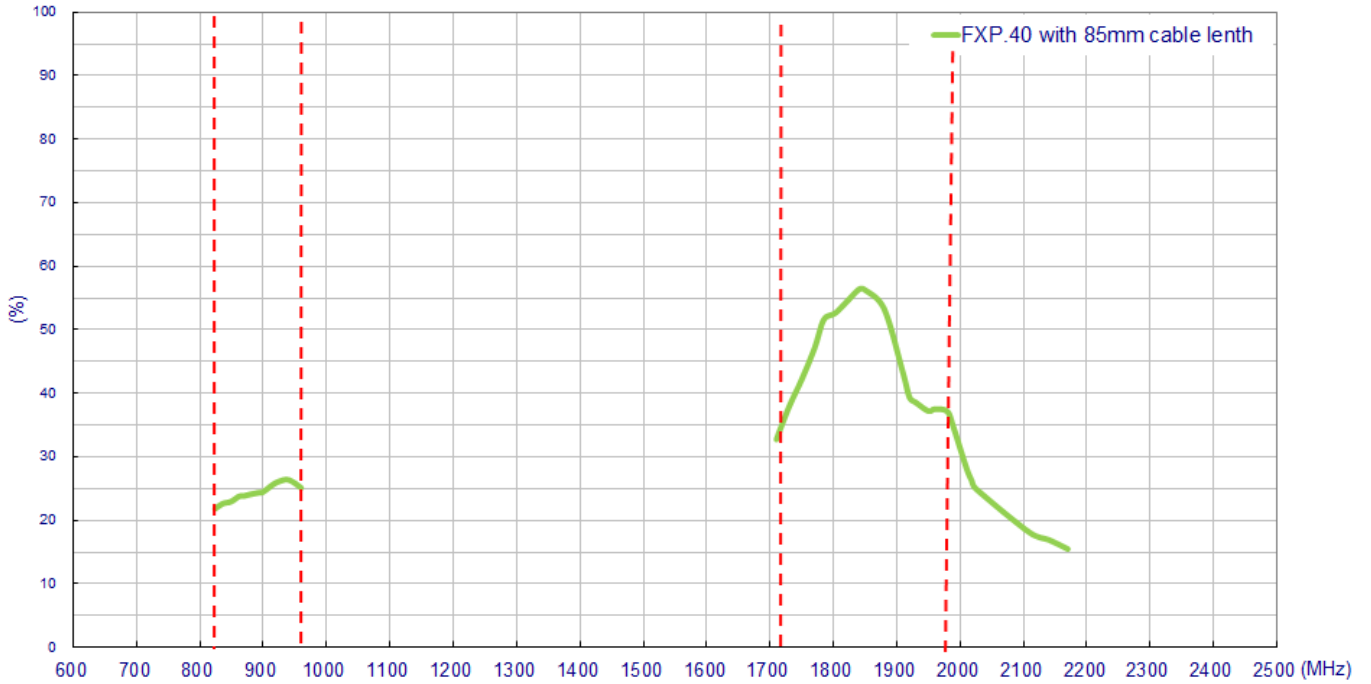

3.4. Average Gain

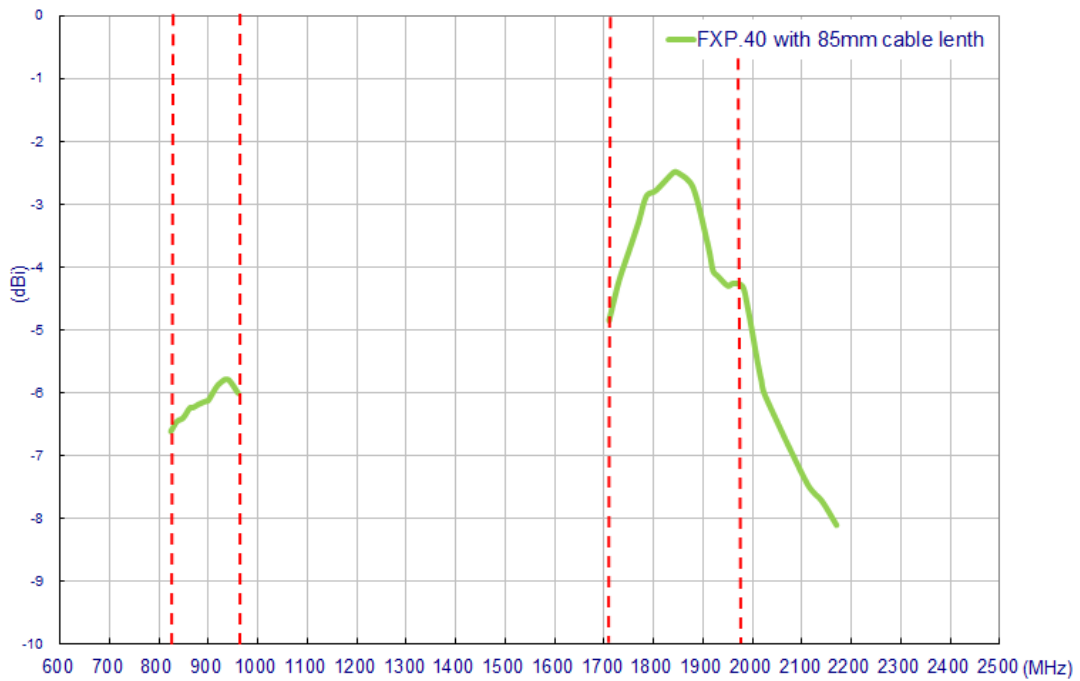

4. Antenna Radiation Patterns

4.1. Antenna setup

The antenna radiation pattern measured setup as shown the below,



4.2. Antenna radiation patterns

XY Plane

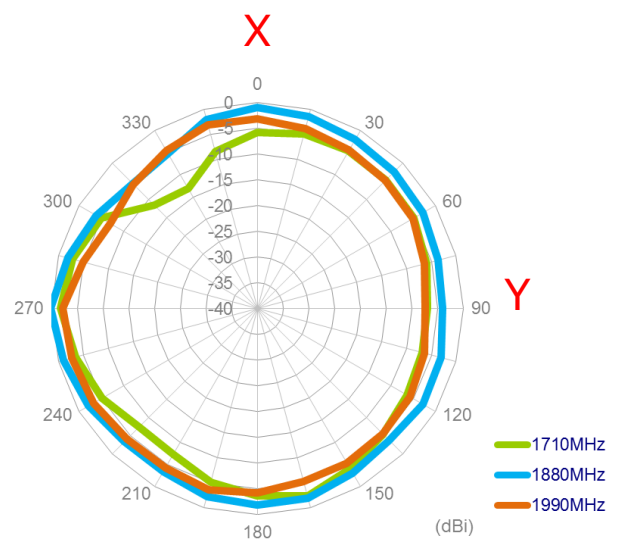
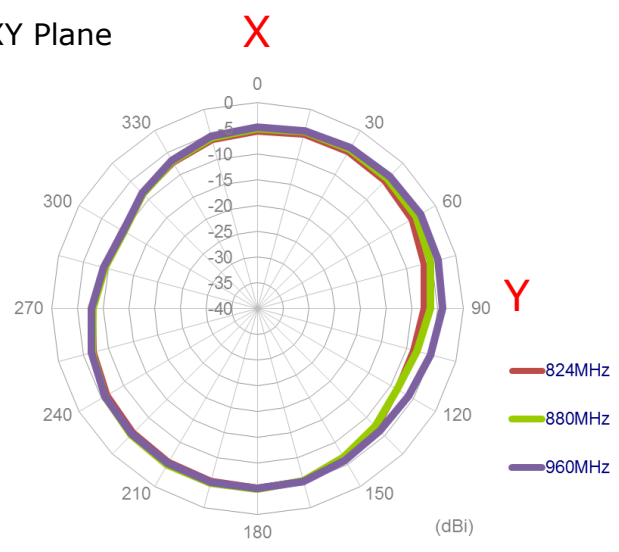

XZ Plane

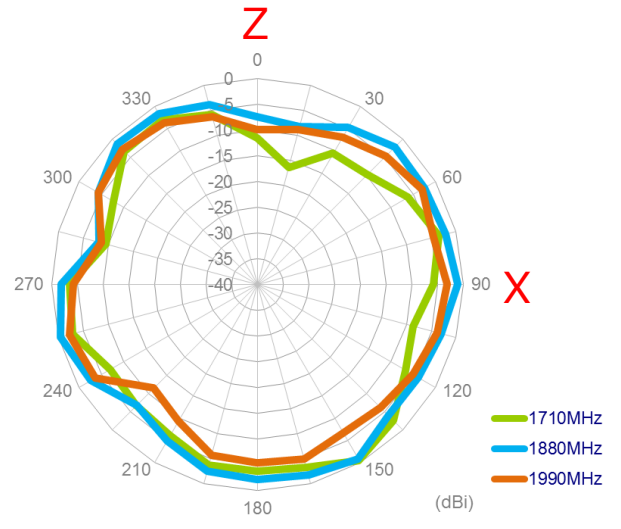
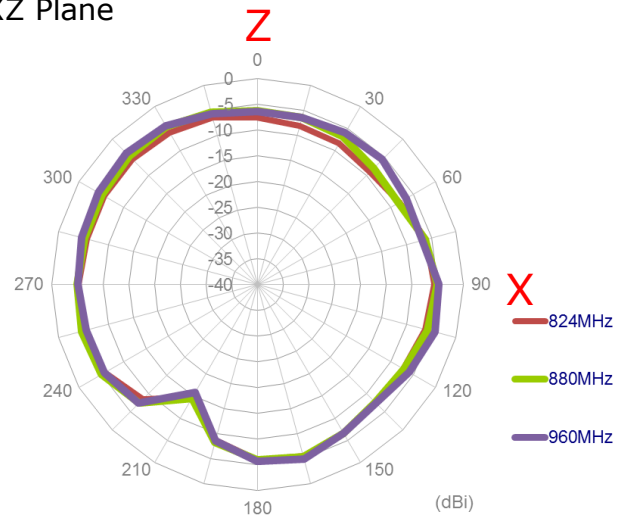

YZ Plane

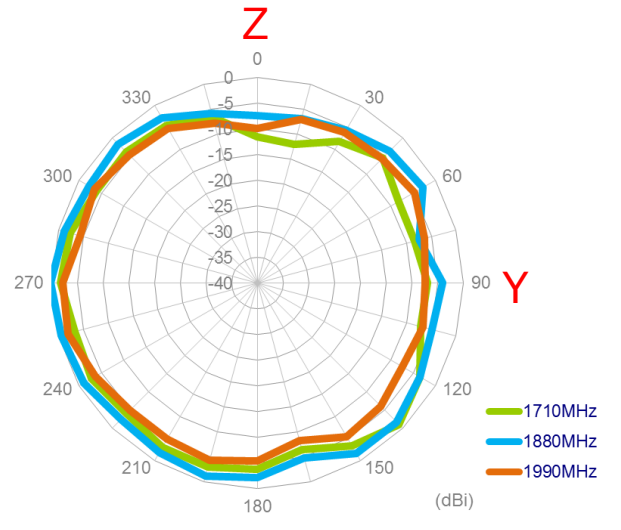
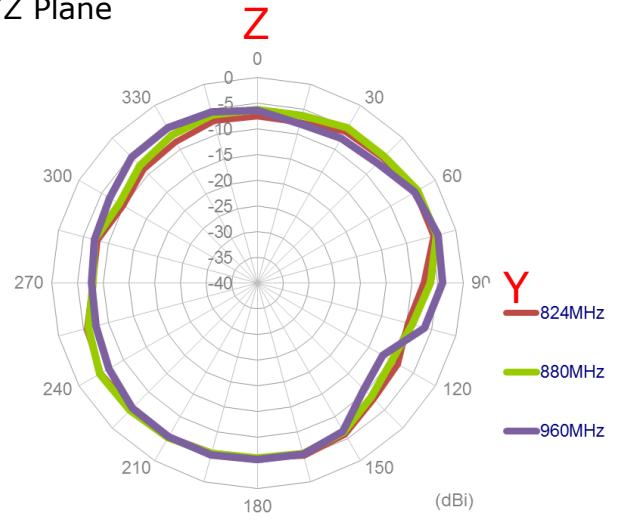

5. Mechanical Drawings (Unit: mm)

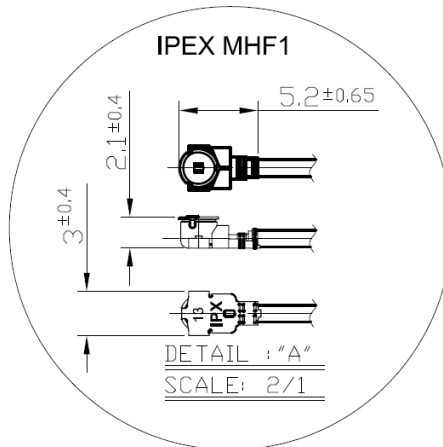
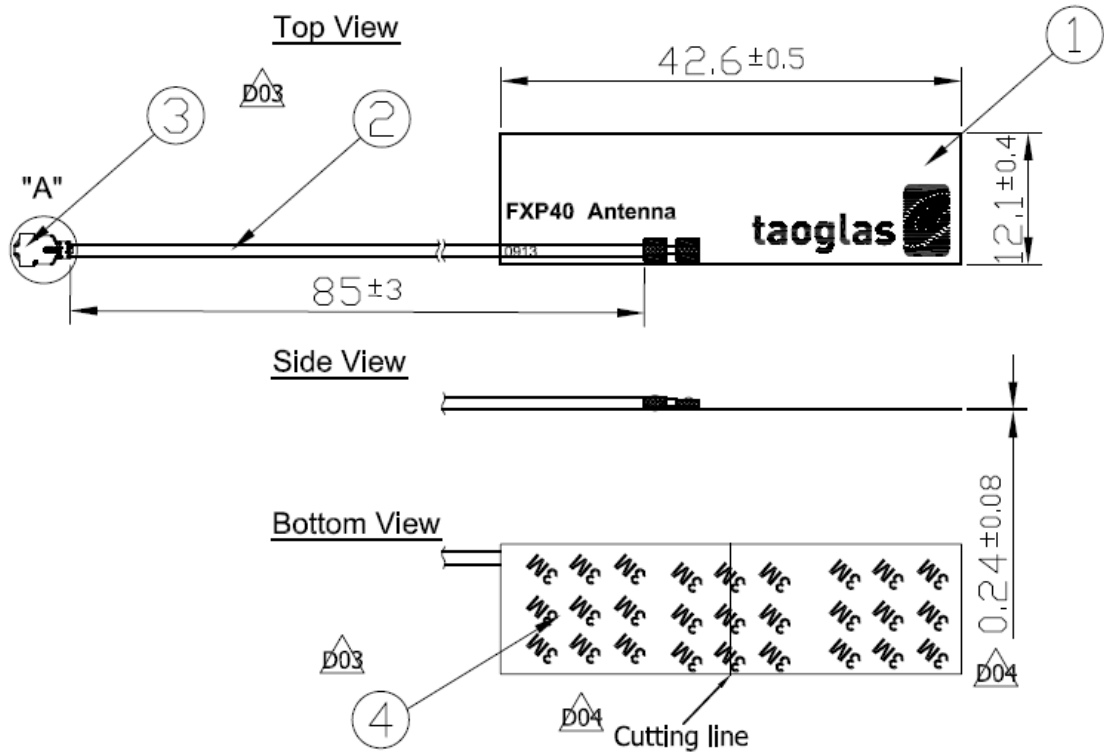

	Name	P/N	Material	Finish	QTY
①	FXP40 PCB	100113I010011A	FPCB 0.1t	Black	1
②	1.13 Coaxial Cable	300213A000013A	FEP	Black	1
③	IPEX MHF1	204111D000013A	Brass	Gold	1
④	Double-Sided Adhesive	100113I010011A	3M 467	Brown Liner	1

6. Application Note

The FXP40 antenna measurement with difference cable length on plastic plate of 2 mm thickness, the performance is shown as below,

6.1. Return loss

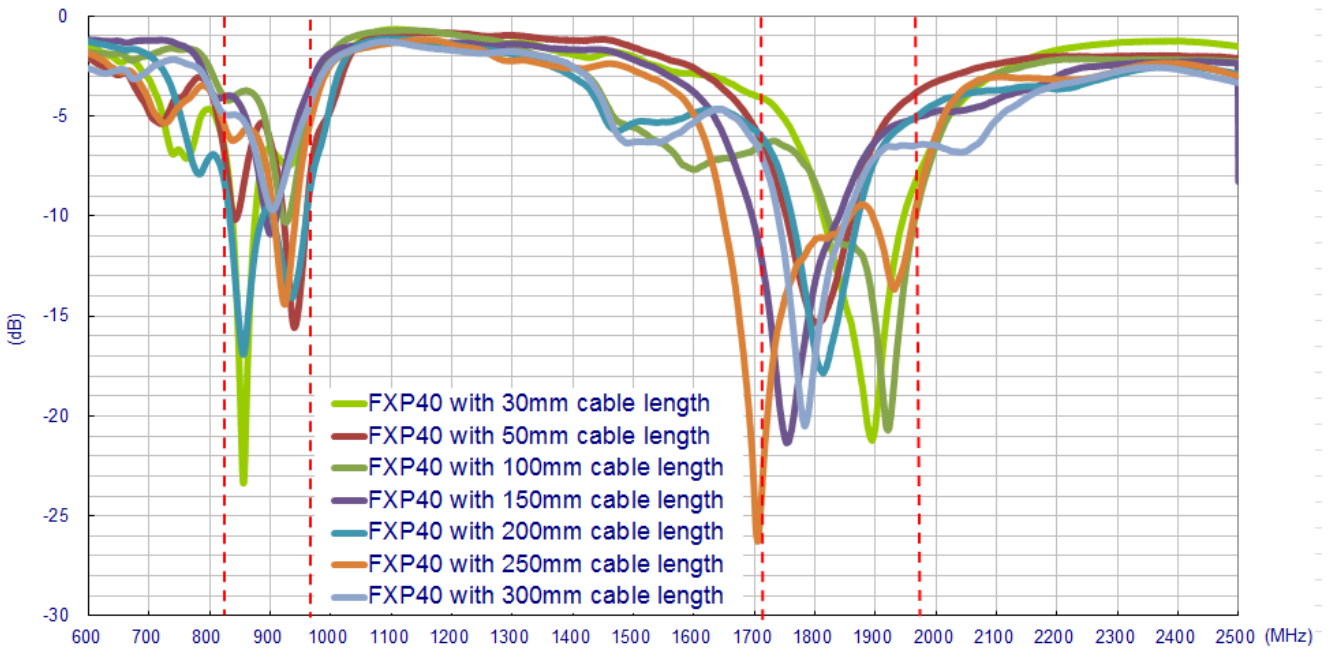

6.2. Efficiency

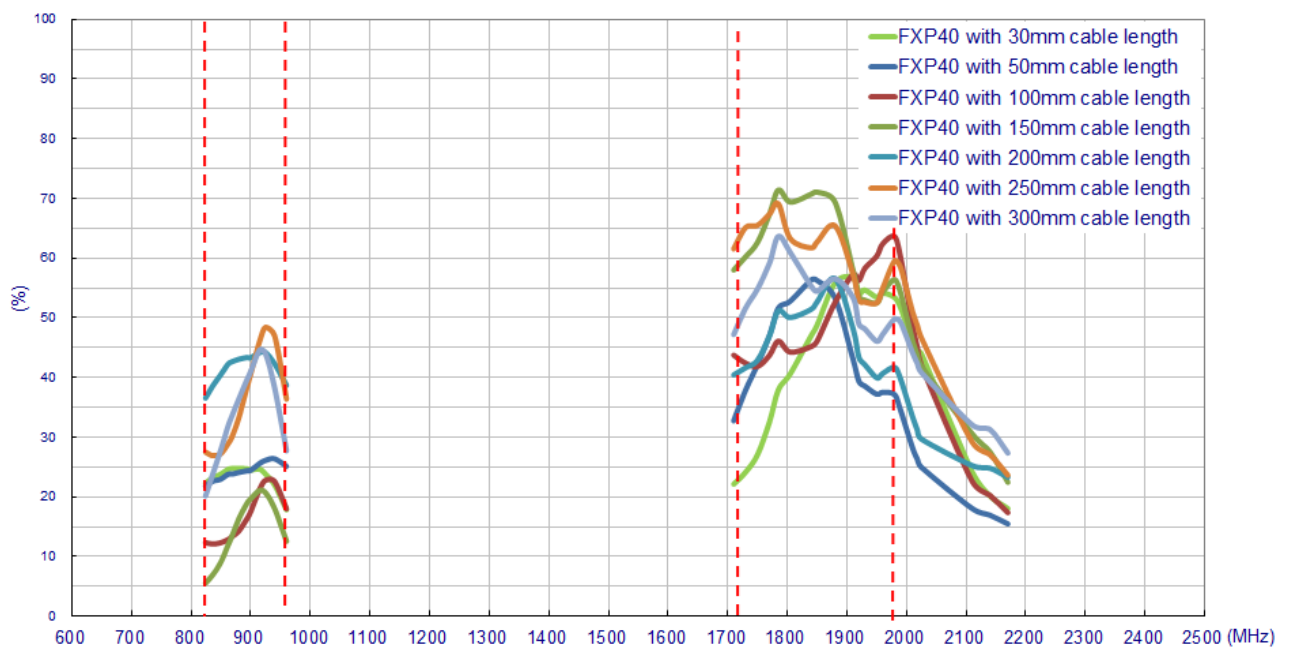

6.3. Average Gain

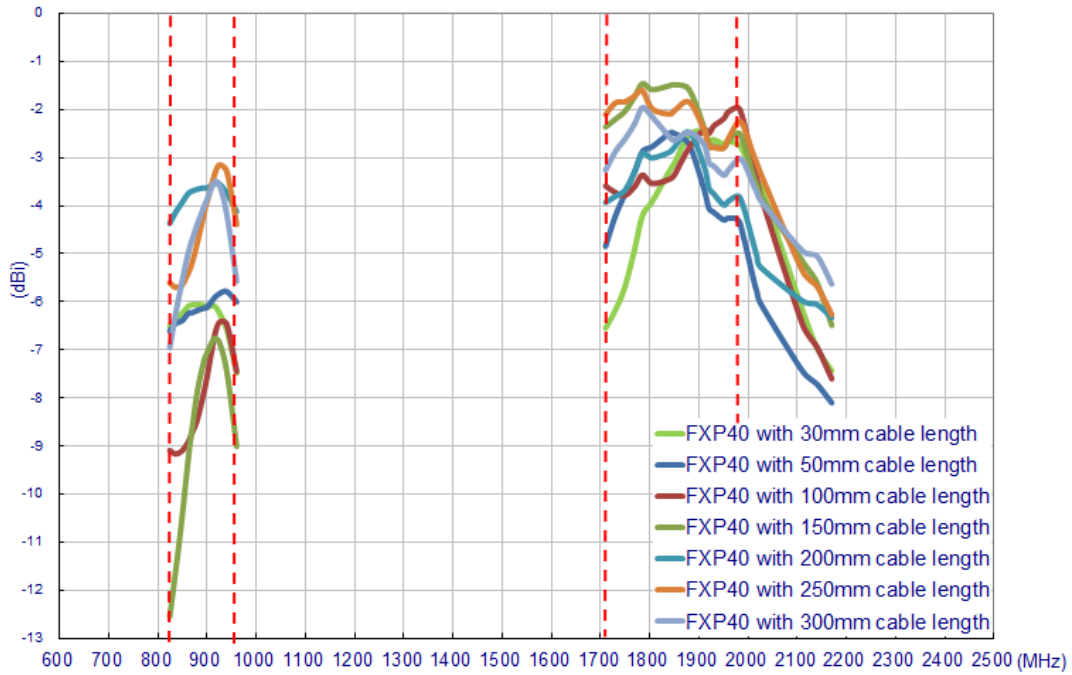

6.4. Peak Gain

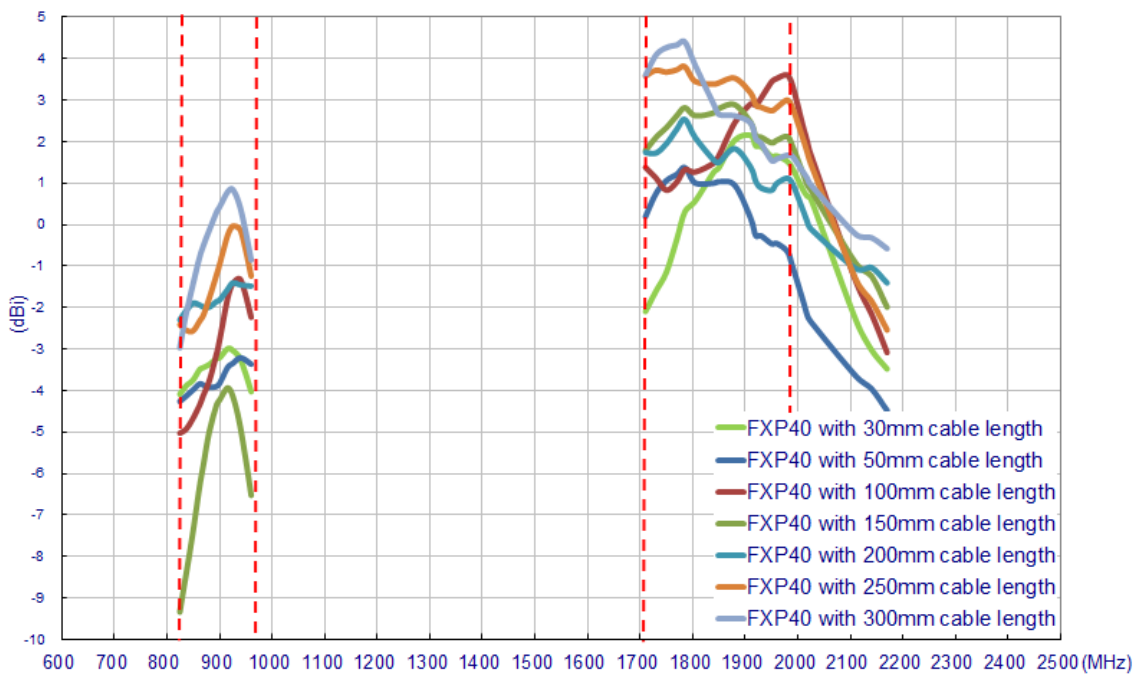

7. Packaging

Package:

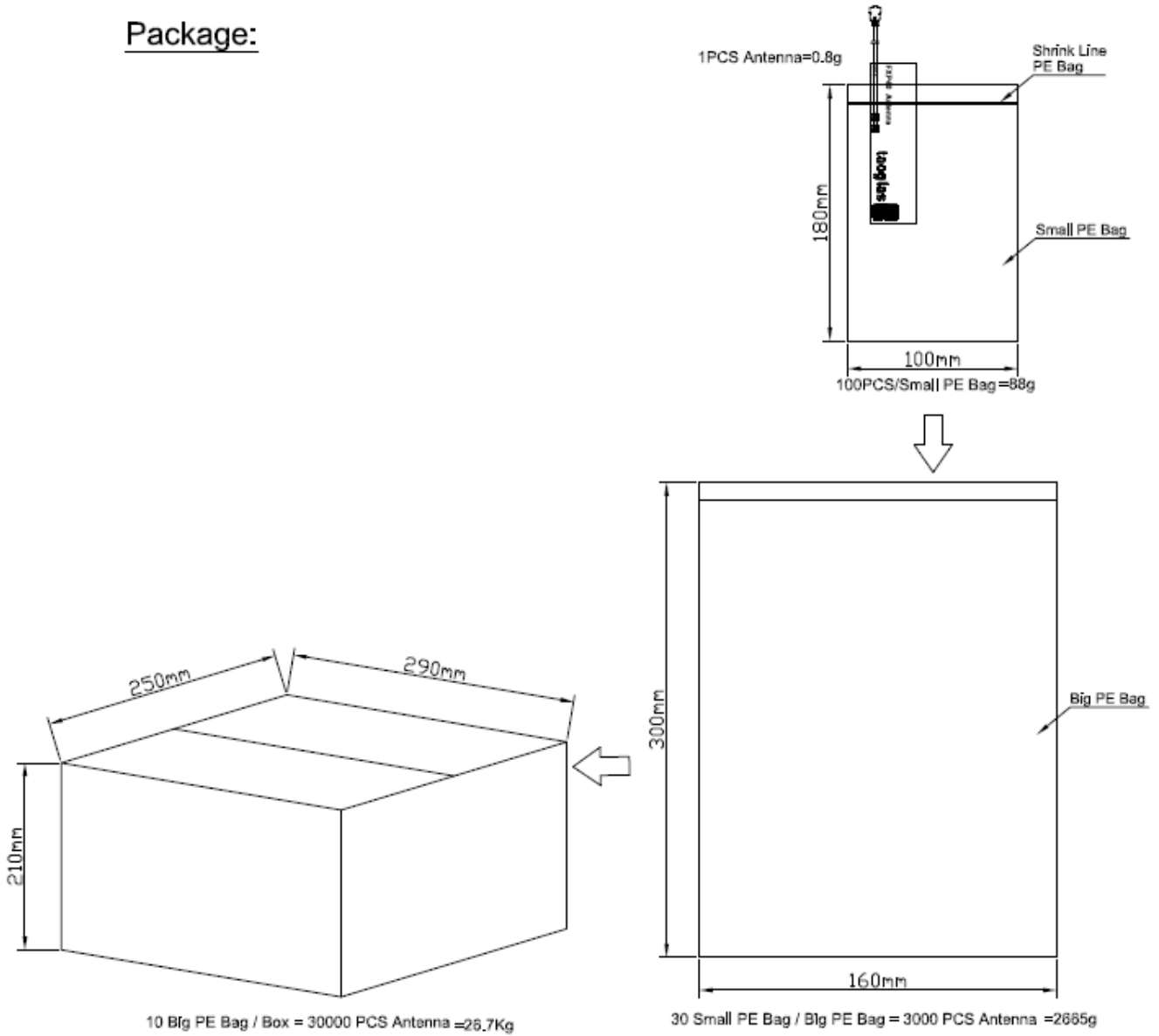

Taoglas makes no warranties based on the accuracy or completeness of the contents of this document and reserves the right to make changes to specifications and product descriptions at any time without notice. Taoglas reserves all rights to this document and the information contained herein.

Reproduction, use or disclosure to third parties without express permission is strictly prohibited.

Copyright © Taoglas Ltd.