

ER2A-ER2J SURFACE MOUNT SUPER FAST RECTIFIER

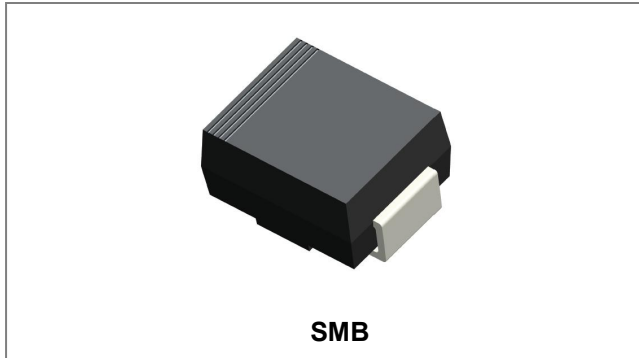

Features

- Glass Passivated Die Construction
- Ideally Suited for Automatic Assembly
- Low Forward Overload Drop, High Efficiency
- Low Power Loss
- Super-Fast Recovery Time
- Plastic Case Material has UL Flammability Classification Rating 94V-O
- This is a Pb – Free Device
- All SMC parts are traceable to the wafer lot
- Additional testing can be offered upon request

Circuit Diagram



Mechanical Data

- Case: Low Profile Molded Plastic
- Terminals: Solder Plated, Solderable per MIL-STD-750, Method 2026
- Polarity: Cathode Band or Cathode Notch
- Marking: Type Number
- Weight: 0.09grams(approx)

Maximum Ratings and Electrical Characteristics @ $T_A=25^\circ\text{C}$ unless otherwise specified

Characteristic	Symbol	ER2A	ER2B	ER2C	ER2D	ER2E	ER2G	ER2J	Units	
Peak Repetitive Reverse Voltage	V_{RRM}	50	100	150	200	300	400	600	V	
Working Peak Reverse Voltage	V_{RWM}									
DC Blocking Voltage	V_R									
RMS Reverse Voltage	$V_{R(RMS)}$	35	70	105	140	210	280	420		
Average Rectified Output Current @ $T_L = 110^\circ\text{C}$	I_o	2.0							A	
Peak Forward Surge Current 8.3ms Single half sine-wave superimposed on rated load (JEDEC Method)	I_{FSM}	50							A	
Forward Voltage @ $I_F = 2.0\text{A}, T_J = 25^\circ\text{C}$	V_F	0.95			1.25		1.7		V	
Maximum DC reverse current at rated DC blocking voltage $T_A = 25^\circ\text{C}$ $T_A = 125^\circ\text{C}$	I_R	5.0				100			μA	
Typical junction capacitance (Note 1)	C_J	25								pF
Maximum Reverse Recovery Time (Note 2)	T_{rr}	35								ns
Typical thermal resistance (Note 3)	$R_{\theta JL}$	20								$^\circ\text{C/W}$
Operating junction and storage temperature range	T_J, T_{STG}	-65 to +150							$^\circ\text{C}$	

Note: 1. Measured at 1.0 MHz and applied reverse voltage of 4.0 V_{DC}
 2. Measured with $I_F=0.5\text{A}$, $I_R=1.0\text{A}$, $I_{rr}=0.25\text{A}$,
 3. Mounted on P.C. Board with 8.0mm² lead area

Ratings and Characteristics Curves

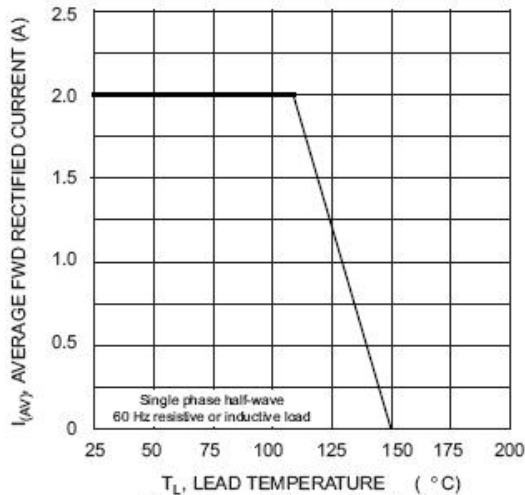

Fig. 1 Forward Current Derating Curve

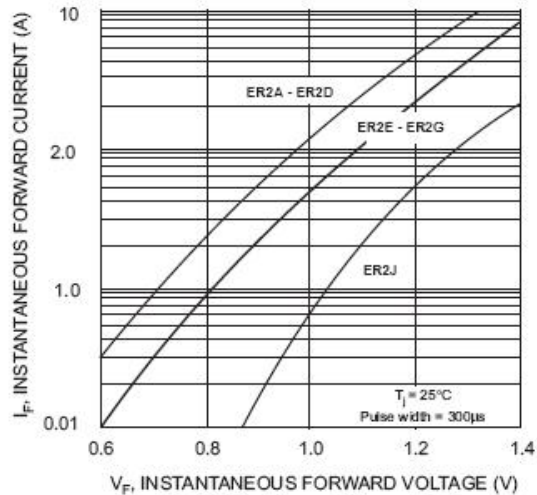

Fig. 2 Typical Forward Characteristics

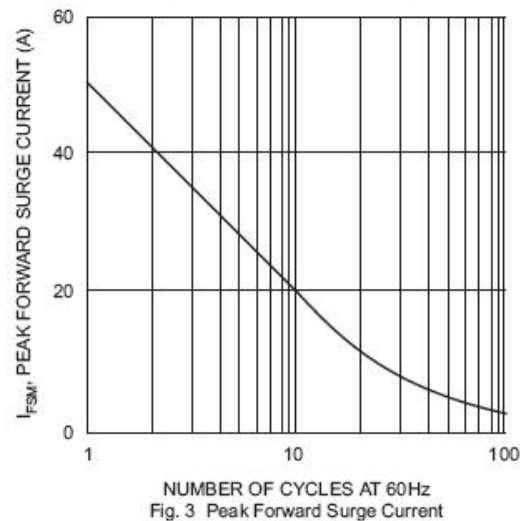

Fig. 3 Peak Forward Surge Current

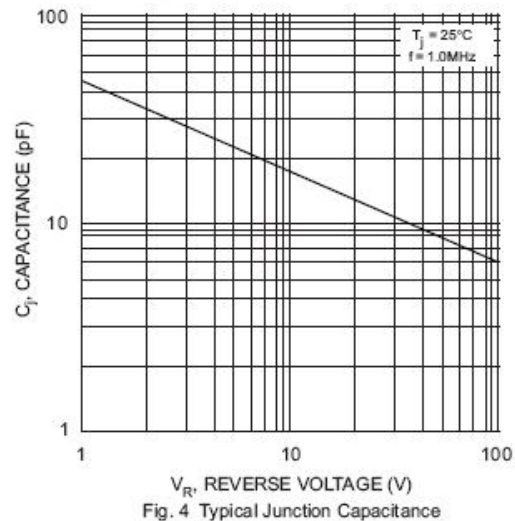
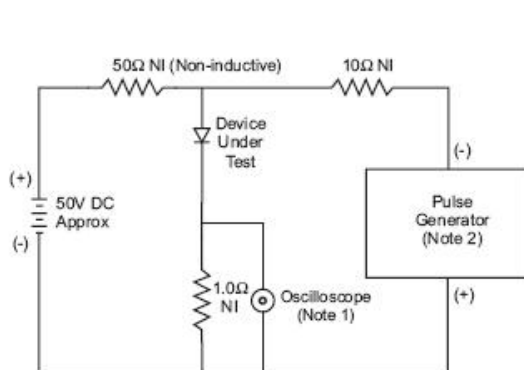

Fig. 4 Typical Junction Capacitance



Notes:
1. Rise Time = 7.0ns max. Input Impedance = 1.0MΩ, 22pF.
2. Rise Time = 10ns max. Input Impedance = 50Ω.

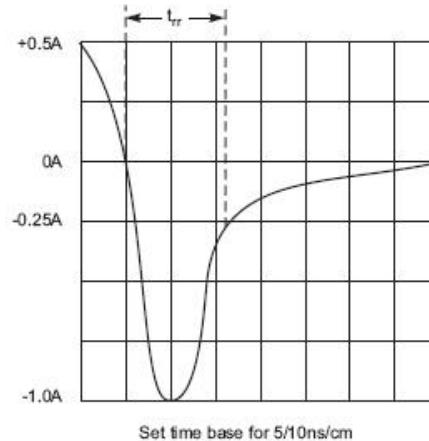
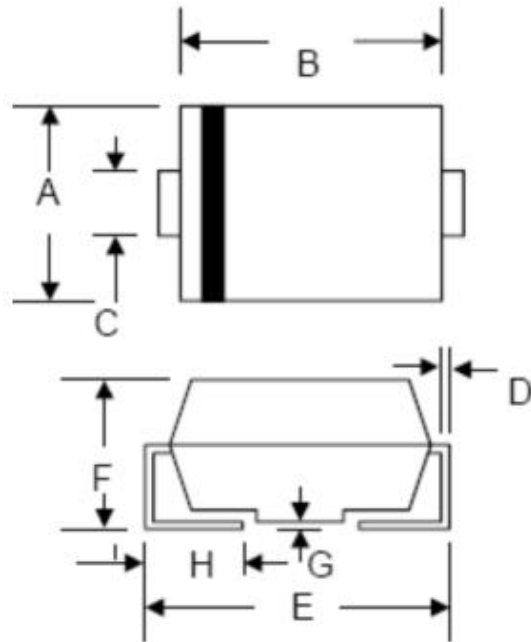

Fig. 5 Reverse Recovery Time Characteristic and Test Circuit

Mechanical Dimensions SMB



SYMBOL	Millimeters		Inches	
	Min.	Max.	Min.	Max.
A	3.30	3.94	0.130	0.155
B	4.06	4.70	0.160	0.185
C	1.80	2.20	0.071	0.087
D	0.152	0.305	0.006	0.012
E	4.80	5.59	0.189	0.220
F	2.10	2.60	0.083	0.102
G	0.051	0.203	0.002	0.008
H	0.76	1.52	0.030	0.060

Suggested Solder Pad Layout (Millimeters/Inches)

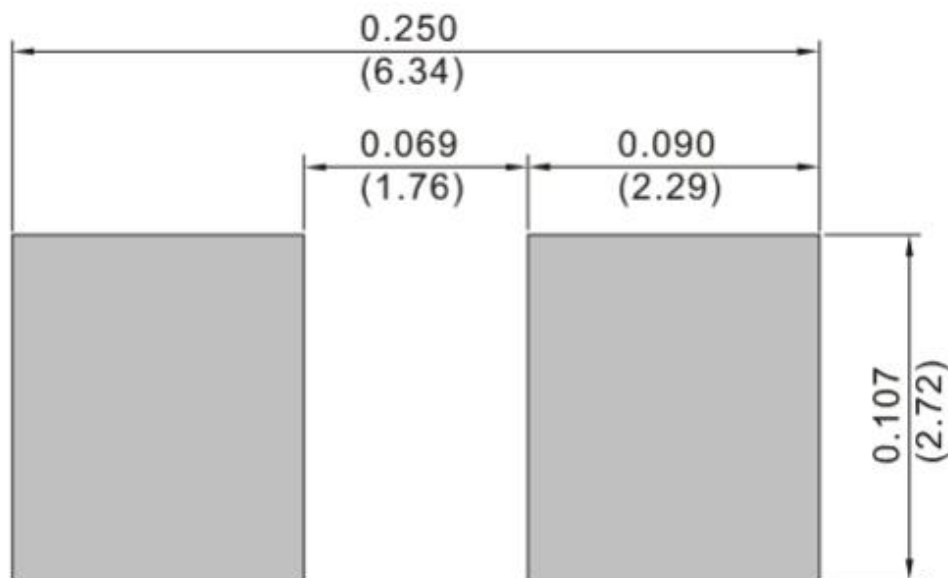

Ordering Information

Device	Package	Shipping
ER2A-ER2J	SMB (Pb-Free)	3000pcs / reel

For information on tape and reel specifications, including part orientation and tape sizes, please refer to our tape and reel packaging specification.

Marking Diagram

Where XXXXX is YYWWL

ER = Device Type
 2 = Forward Current (2A)
 A = Reverse Voltage (50V)
 YY = Year
 WW = Week
 L = Lot Number

Cautions: Molding resin
 Epoxy resin UL:94V-0

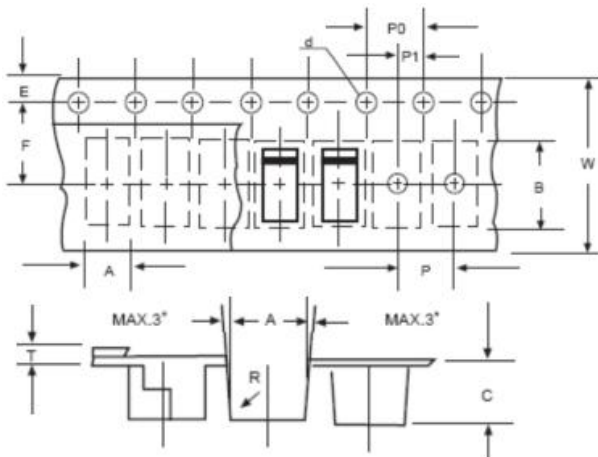
Carrier Tape Specification SMB

SYMBOL	Millimeters	
	Min.	Max.
A	2.97	3.17
B	5.70	5.90
C	2.32	2.52
d	1.40	1.60
E	1.40	1.60
F	5.60	5.70
P	3.90	4.10
P0	3.90	4.10
P1	1.90	2.10
T	0.25	0.35
W	11.80	12.20

DISCLAIMER:

1- The information given herein, including the specifications and dimensions, is subject to change without prior notice to improve product characteristics. Before ordering, purchasers are advised to contact the SMC Diode Solutions sales department for the latest version of the datasheet(s).

2- In cases where extremely high reliability is required (such as use in nuclear power control, aerospace and aviation, traffic equipment, medical equipment, and safety equipment), safety should be ensured by using semiconductor devices that feature assured safety or by means of users' fail-safe precautions or other arrangement.

3- In no event shall SMC Diode Solutions be liable for any damages that may result from an accident or any other cause during operation of the user's units according to the datasheet(s). SMC Diode Solution assumes no responsibility for any intellectual property claims or any other problems that may result from applications of information, products or circuits described in the datasheets.

4- In no event shall SMC Diode Solutions be liable for any failure in a semiconductor device or any secondary damage resulting from use at a value exceeding the absolute maximum rating.

5- No license is granted by the datasheet(s) under any patents or other rights of any third party or SMC Diode Solutions.

6- The datasheet(s) may not be reproduced or duplicated, in any form, in whole or part, without the expressed written permission of SMC Diode Solutions.

7- The products (technologies) described in the datasheet(s) are not to be provided to any party whose purpose in their application will hinder maintenance of international peace and safety nor are they to be applied to that purpose by their direct purchasers or any third party. When exporting these products (technologies), the necessary procedures are to be taken in accordance with related laws and regulations.