

IDC 0,3/10-3,81

Order No.: 1706251

The figure shows a 10-position version of the product

<http://eshop.phoenixcontact.de/phoenix/treeViewClick.do?UID=1706251>

PC terminal block, Nominal current: 5 A, Nom. voltage: 160 V, Pitch: 3.81 mm, Number of positions: 10, Type of connection: Insulation displacement connection QUICKON, Assembly: Soldering, Conductor/PCB connection direction: 0 °, Color: green

Commercial data

EAN	4017918116750
Pack	50 pcs.
Customs tariff	85369010
Weight/Piece	0.00579 KG
Catalog page information	Page 121 (CC-2009)

Product notes

WEEE/RoHS-compliant since:
01/01/2003



<http://www.download.phoenixcontact.com>
Please note that the data given here has been taken from the online catalog. For comprehensive information and data, please refer to the user documentation. The General Terms and Conditions of Use apply to Internet downloads.

Technical data

Dimensions / positions

Length	10 mm
Pitch	3.81 mm
Dimension a	34.29 mm

Number of positions	10
Pin dimensions	1 x 0,4 mm
Hole diameter	1.3 mm

Technical data

Insulating material group	I
Rated surge voltage (III/3)	2.5 kV
Rated surge voltage (III/2)	2.5 kV
Rated surge voltage (II/2)	2.5 kV
Rated voltage (III/2)	160 V
Rated voltage (II/2)	320 V
Connection in acc. with standard	EN-VDE
Nominal current I_N	5 A
Nominal voltage U_N	160 V
Nominal cross section	0.34 mm ²
Maximum load current	5 A (with 0.34 mm ² conductor cross section)
Insulating material	PA
Inflammability class acc. to UL 94	V0

Connection data

Conductor cross section solid min.	0.13 mm ²
Conductor cross section solid max.	0.34 mm ²
Conductor cross section stranded min.	0.22 mm ²
Conductor cross section stranded max.	0.34 mm ²
Conductor cross section AWG/kcmil min.	26
Conductor cross section AWG/kcmil max	22

Certificates / Approvals



Certification CSA, CUL, GOST, UL

CSA

Nominal voltage U_N	300 V
Nominal current I_N	5 A
AWG/kcmil	28-22

CUL

Nominal voltage U_N	300 V
Nominal current I_N	5 A
AWG/kcmil	28-22

UL

Nominal voltage U_N	300 V
Nominal current I_N	5 A
AWG/kcmil	28-22

Accessories

Item	Designation	Description
0804109	SK 3,81/2,8:FORTL.ZAHLEN	Marker card, printed horizontally, self-adhesive, 10-section marker strip, 14 identical decades marked 1-10, 11-20 etc. up to 91-(99)100, sufficient for 140 terminal blocks

Diagrams/Drawings

Drilling plan/solder pad geometry

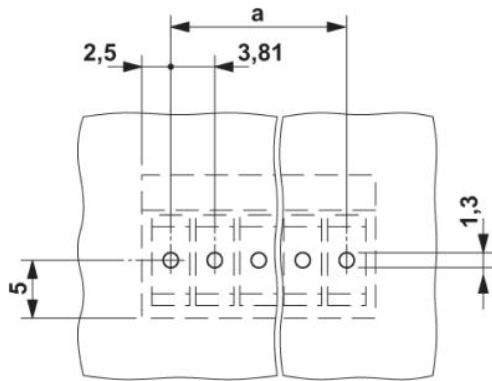

Diagram



- 1 = Limit values acc. to EN 50173 for connection technology
- 2 = NEXT 12-36 on the soldering tag
- 3 = NEXT 12-36 on the contact terminal block

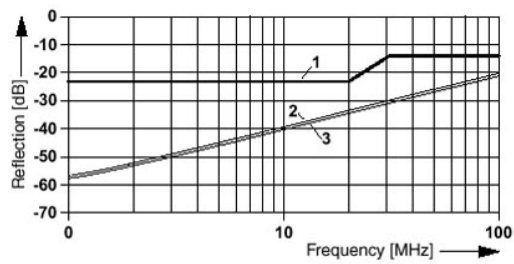

- 1 = Limit values acc. to EN 50173 for connection technology
- 2 = NEXT 12 on the soldering tag
- 3 = NEXT 36 on the soldering tag

Dimensioned drawing

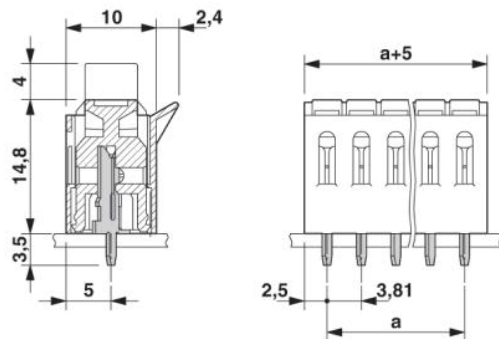

Address

PHOENIX CONTACT Deutschland GmbH
Flachmarktstr. 8
32825 Blomberg, Germany
Phone +49 5235 3 12000
Fax +49 5235 3 41200
<http://www.phoenixcontact.de>



© 2010 Phoenix Contact
Technical modifications reserved;