

ULS 30-Watt Series

Sixteenth-brick DOSA-Compatible,
Isolated DC/DC Converters

FEATURES

- Small footprint DC/DC converter, ideal for embedded applications
- 1.30" x 0.90" x 0.36" open frame package
- Industry standard DOSA "brick" format and pinout with surface mount option
- 2:1 Input Voltage Range (36V-75V, D48)
- 2250 Volt Basic input/output isolation (48V models)
- Up to 30 Watts total output power with overtemperature shutdown
- High efficiency synchronous rectifier forward topology
- Stable no-load operation with no required external components
- Operating temperature range -40 to +85°C with derating
- Certified to UL/EN/IEC 60950-1, CAN/CSA C22.2 No. 60950-1, EN60950-1 safety approvals, 2nd Edition
- Extensive self-protection shut down features

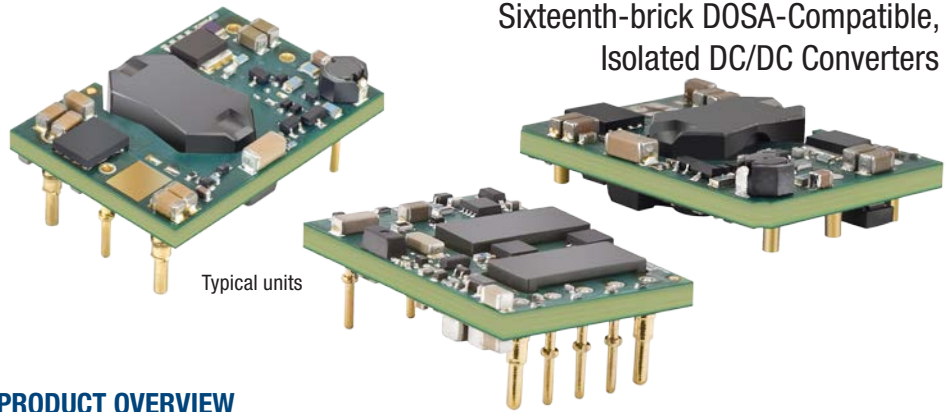

PRODUCT OVERVIEW

The world of "brick" DC/DC converters has seen a steady size reduction. The ULS series makes another dramatic size shrink down to a "sixteenth-brick" width (0.91 inches) while still retaining up to 30 Watt output and full 2250 Volt DC isolation. The PC-board mount converter family accepts 36 to 75 Volts DC inputs and delivers fixed outputs regulated to within $\pm 0.125\%$. The ULS converters are ideal for datacom and telecom applications, cell phone towers, data centers, server farms and network repeaters.

ULS outputs may be trimmed within -20% to +10% of nominal output while delivering fast settling to current step loads and no adverse effects from higher capacitive loads. Excellent ripple and noise specifications assure compatibility to circuits

using CPU's, ASIC's, programmable logic and FPGA's. No minimum load is required. For systems requiring controlled startup/shutdown, an external remote On/Off control may use a switch, transistor or digital logic.

Many self-protection features on the ULS series avoid both converter and external circuit hazards. These include input undervoltage lockout and overtemperature shutdown. The outputs current limit using the "hiccup" autorestart technique and the outputs may be short-circuited indefinitely. Additional features include output overvoltage and reverse conduction elimination.

The synchronous rectifier forward topology yields high efficiency for minimal heat buildup and "no fan" operation.

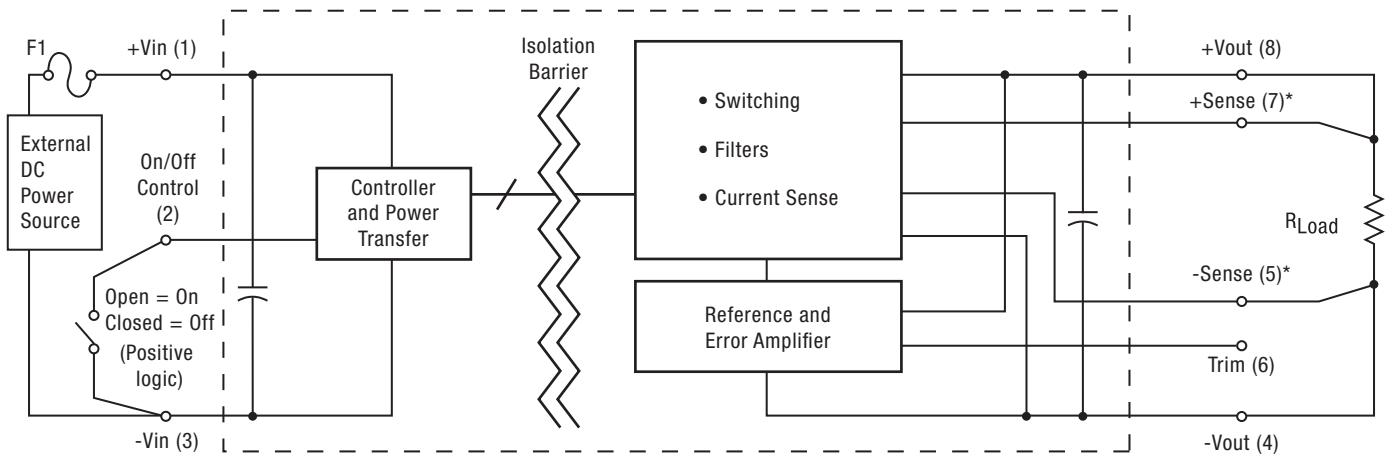

*Sense is included on the ULS-3.3/8-D48 and ULS-5/6-D48 only.

Figure 1. Simplified Block Diagram

Typical topology is shown



PERFORMANCE SPECIFICATIONS SUMMARY AND ORDERING GUIDE ①														
Root Model ①	Output						Input				Efficiency		Case (inches)	
	V _{OUT} (V)	I _{OUT} (A, max.)	Power (W)	R/N (mV pk-pk)		Regulation (max.) ③		V _{IN} Nom. (V)	Range (V)	I _{IN} , no load (mA)	I _{IN} , full load (A)	Min.		Typ.
				Typ.	Max.	Line	Load							
ULS-3.3/8-D48	3.3	8	26.5	90	130	±0.1%	±0.1%	48	36-75	75	0.58	89%	90%	1.30x0.90x0.36
ULS-5/6-D48	5	6	30	75	100	±0.125%	±0.1%	48	36-75	20	0.69	89%	91%	1.30x0.90x0.36
ULS-12/2.5-D48	12	2.5	30	130	150	±0.125%	±0.125%	48	36-75	25	0.71	86%	87.7%	1.30x0.90x0.36
ULS-15/2-D48	15	2	30	115	125	±0.125%	±0.125%	48	36-75	25	0.70	87.5%	89%	1.30x0.90x0.36

① Please refer to the Part Number Structure when ordering.
 ② All specifications are typical at nominal line voltage and full load, +25°C unless otherwise noted. See detailed specifications. Output capacitors are 1 µF ceramic multilayer in parallel with 10 µF electrolytic. I/O caps are necessary for our test equipment and may not be needed for your application.
 ③ Regulation specifications describe output voltage deviations from a nominal/midpoint value to either extreme (50% load step).

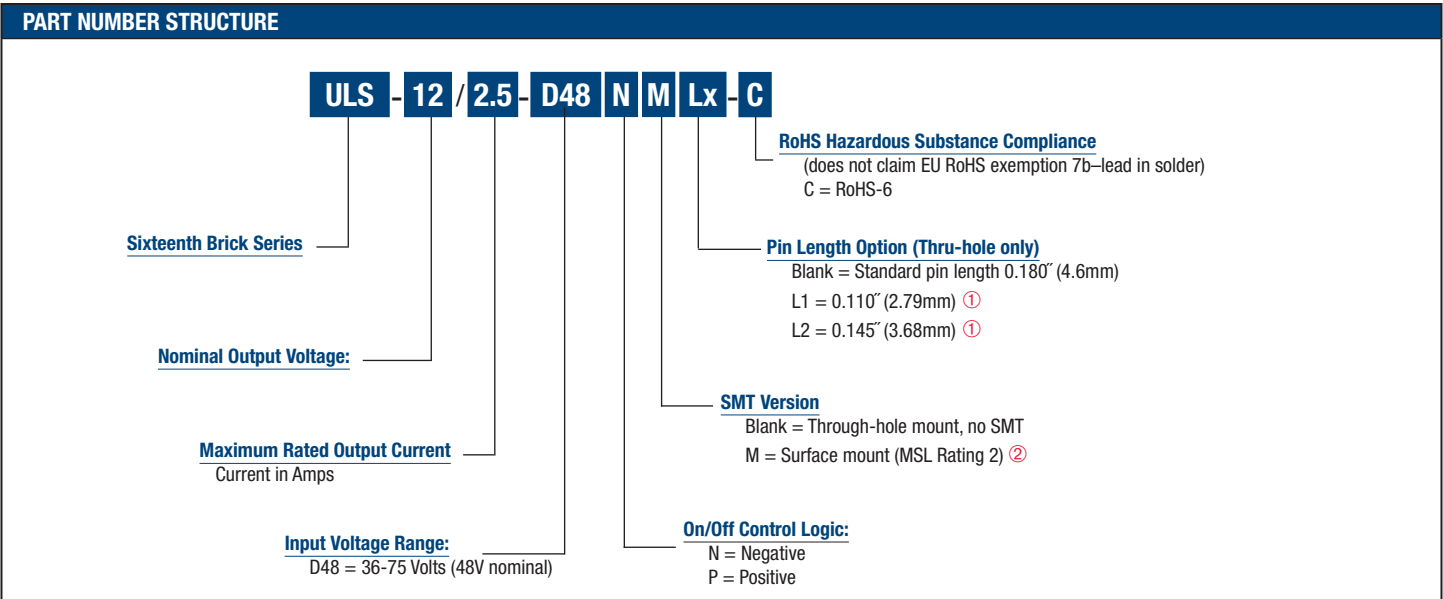

- ① Special quantity order is required; samples available with standard pin length only.
- ② SMT (M) versions not available in sample quantities.
- ③ Some model number combinations may not be available. See website or contact your local Murata sales representative.

FUNCTIONAL SPECIFICATIONS, ULS-3.3/8-D48

ABSOLUTE MAXIMUM RATINGS	Conditions ①	Minimum	Typical/Nominal	Maximum	Units
Input Voltage, Continuous		0		80	Vdc
Input Voltage, Transient	100 mS max. duration			100	Vdc
Isolation Voltage	Input to output, continuous			2250	Vdc
Input Reverse Polarity	None, install external fuse		None		Vdc
On/Off Remote Control	Power on, referred to -Vin	0		15	Vdc
Output Power		0		26.66	W
Output Current	Current-limited, no damage, short-circuit protected	0		8	A
Storage Temperature Range	Vin = Zero (no power)	-55		125	°C
Absolute maximums are stress ratings. Exposure of devices to greater than any of these conditions may adversely affect long-term reliability. Proper operation under conditions other than those listed in the Performance/Functional Specifications Table is not implied or recommended.					
INPUT	Conditions ① ③				
Operating voltage range		36	48	75	Vdc
Recommended External Fuse	Fast blow			1.5	A
Start-up threshold	Rising input voltage	34	35.2	36	Vdc
Undervoltage shutdown	Falling input voltage	32	34	35.2	Vdc
Turn-On/Turn-Off Hysteresis			1.5		Vdc
Overvoltage shutdown			None		Vdc
Reverse Polarity Protection	None, install external fuse		None		Vdc
Internal Filter Type			LC		
Input current					
Full Load Conditions	Vin = nominal		0.58	0.63	A
Low Line	Vin = minimum		0.77	0.83	A
Inrush Transient			0.05		A ² -Sec.
Output in Short Circuit			50	100	mA
No Load	Iout = minimum, unit = ON		75	100	mA
Shut-Down Input Current (Off, UV, OT)			1	2	mA
Reflected (back) ripple current ②	Measured at input with specified filter		30		mA, p-p
GENERAL and SAFETY					
Efficiency	Vin = 48V, full load	89	90		%
	Vin = min., full load	89.5	90.5		%
Isolation					
Isolation Voltage	Input to output, continuous	2250			Vdc
Insulation Safety Rating			basic		
Isolation Resistance		10			MΩ
Isolation Capacitance			1000		pF
Safety	Certified to UL-60950-1, CSA-C22.2 No. 60950-1, IEC/EN60950-1, 2nd edition		Yes		
Calculated MTBF	Per Telcordia SR332, issue 1, class 3, ground fixed, Tambient = +25°C		2		Hours x 10 ⁶
DYNAMIC CHARACTERISTICS					
Fixed Switching Frequency		320	350	380	KHz
Startup Time	Power on to Vout regulated			50	mS
Startup Time	Remote ON to Vout regulated			50	mS
Dynamic Load Response	50-75-50% load step, settling time to within 2% of Vout		100	150	μSec
Dynamic Load Peak Deviation	same as above		±30	±100	mV
FEATURES and OPTIONS					
Remote On/Off Control ⑤					
"N" suffix:					
Negative Logic, ON state	ON = Ground pin or external voltage	-0.7		1.2	V
Negative Logic, OFF state	OFF = Pin open or external voltage	10		15	V
Control Current	Open collector/drain		1		mA
"P" suffix:					
Positive Logic, ON state	ON = Pin open or external voltage	10		15	V
Positive Logic, OFF state	OFF = Ground pin or external voltage	-0.7		1.2	V
Control Current	Open collector/drain		1		mA
SMT Mounting	"M" suffix				

FUNCTIONAL SPECIFICATIONS, ULS-3.3/8-D48 (CONT.)

OUTPUT	Conditions ①	Minimum	Typical/Nominal	Maximum	Units
Total Output Power	See Derating	2.61	25	26.66	W
Voltage					
Nominal Output Voltage	No trim	3.2674	3.3	3.333	Vdc
Setting Accuracy	At 50% load, no trim	-1		1	% of Vnom
Output Voltage Range	User-adjustable	-10		10	% of Vnom.
Overvoltage Protection	Via magnetic feedback	4.2	5	5.7	Vdc
Current					
Output Current Range		0.8	8	8	A
Minimum Load					
Current Limit Inception	98% of Vnom., after warmup	8.5	10	11.3	A
Short Circuit					
Short Circuit Current	Hiccup technique, autorecovery within $\pm 1.25\%$ of Vout			0.3	mA
Short Circuit Duration (remove short for recovery)	Output shorted to ground, no damage		Continuous		
Short circuit protection method	Current limiting				
Regulation ⑥					
Line Regulation	Vin = min. to max., Vout = nom., Iout = nom.			± 0.1	% of Vout
Load Regulation	Iout = min. to max., Vin = 48V			± 0.1	% of Vout
Ripple and Noise	5 Hz- 20 MHz BW		90	130	mV pk-pk
Temperature Coefficient	At all outputs		± 0.02		% of Vout./°C
Maximum Capacitive Loading	Low ESR, resistive load only			2000	μ F
MECHANICAL (Through Hole Models)					
Conditions ① ③					
Outline Dimensions			1.30x0.90x0.36		Inches
(Please refer to outline drawing)	LxWxH		33.02x22.86x9.144		mm
Weight			0.58		Ounces
			16.4		Grams
Through Hole Pin Diameter			0.04 & 0.062		Inches
			1.016 & 1.575		mm
Through Hole Pin Material			Copper alloy		
TH Pin Plating Metal and Thickness	Nickel subplate		50		μ -inches
	Gold overplate		5		μ -inches
ENVIRONMENTAL					
Operating Ambient Temperature Range	With Derating	-40		85	°C
Operating Case Temperature Range	No derating, full power, 200lfm, Vertical mount	-40		70	°C
Storage Temperature	Vin = Zero (no power)	-55		125	°C
Thermal Protection/Shutdown	Measured in center	110	115	120	°C
Electromagnetic Interference	External filter is required				
Conducted, EN55022/CISPR22			B		Class
Radiated, EN55022/CISPR22			B		Class
Relative humidity, non-condensing	To +85°C	10		90	%RH
Altitude	must derate -1%/1000 feet	-500		10,000	feet
		-152		3048	meters
RoHS rating ④			RoHS-6		

Performance Specification Notes

- ① Unless otherwise noted, all specifications are typical at nominal input voltage, nominal output voltage and full load. General conditions are +25° Celsius ambient temperature, near sea level altitude, natural convection airflow. All models are tested and specified with external parallel 1 μ F and 10 μ F multi-layer ceramic output capacitors. The external input capacitor is 22 μ F ceramic. All capacitors are low-ESR types wired close to the converter. These capacitors are necessary for our test equipment and may not be needed in the user's application.
- ② Input (back) ripple current is tested and specified over 5 Hz to 20 MHz bandwidth. Input filtering is Cbus = 220 μ F/100V, Cin = 33 μ F/100V and Lbus = 12 μ H.

- ③ All models are stable and regulate to specification under no load.
- ④ Reduction of Hazardous Substances (RoHS) compliance is to RoHS-6 (six substances restricted including lead). See specifications.
- ⑤ The Remote On/Off Control is referred to -Vin.
- ⑥ Regulation specifications describe the output voltage changes as the line voltage or load current is varied from its nominal or midpoint value to either extreme.

TYPICAL PERFORMANCE CURVES, ULS-3.3/8-D48

Efficiency vs. Line Voltage and Load Current @ 25°C

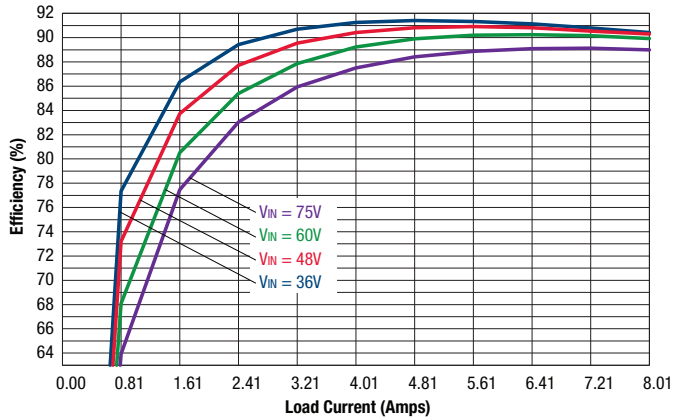

Maximum Current Temperature Derating at Sea Level
(VIN = 36-75V, airflow is from pin 1 to pin 3)

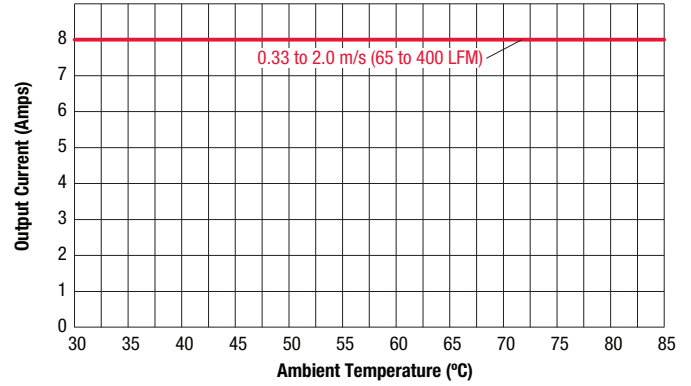

INFRARED THERMAL IMAGE, ULS-3.3/8-D48

Thermal image with hot spot at full load current with 25°C ambient temperature. Natural convection is used with no forced airflow. Identifiable and recommended maximum value to be verified in application. Vin=48V, Q7 max temp=120°C/IPC9592 guidelines.

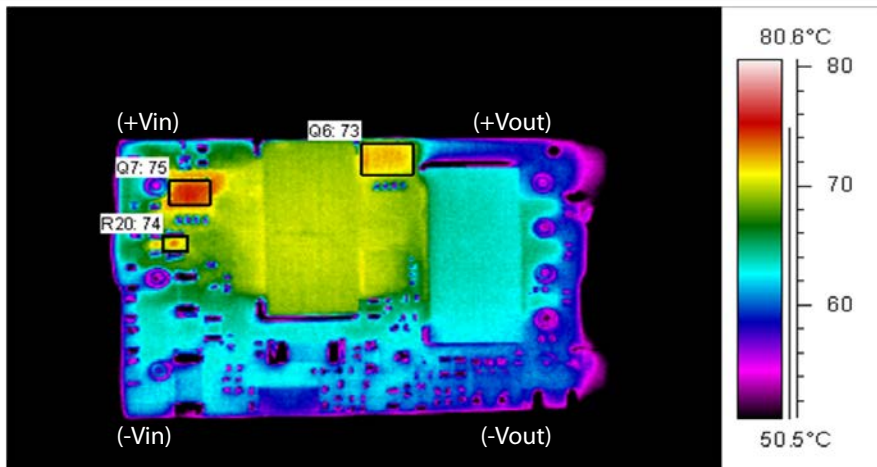

OSCILLOGRAMS, ULS-3.3/8-D48

On/Off Enable Delay (Vin=36V, vout=nom, Iout=8A, Cload =1uF || 10uF, Ta=+25°C, ScopeBW=20Mhz) Trace 1= Enable, Trace 3= Vout.

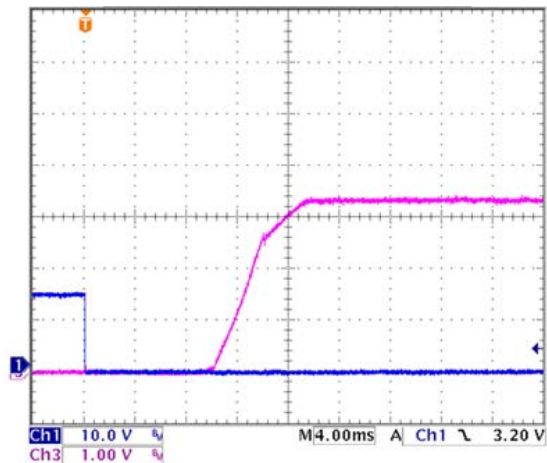

On/Off Enable Delay (Vin=75V, vout=nom, Iout=8A, Cload =1uF || 10uF, Ta=+25°C, ScopeBW=20Mhz) Trace 1= Enable, Trace 3= Vout.

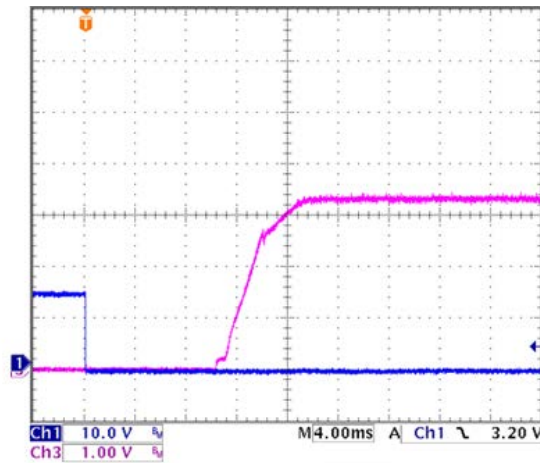

Startup Delay (Vin=48V, Vout=nom, Iout=8A, Cload= 1uF || 10 uF, Ta=+25°C, ScopeBW=20Mhz) Trace 1= Vin, Trace3, Vout.

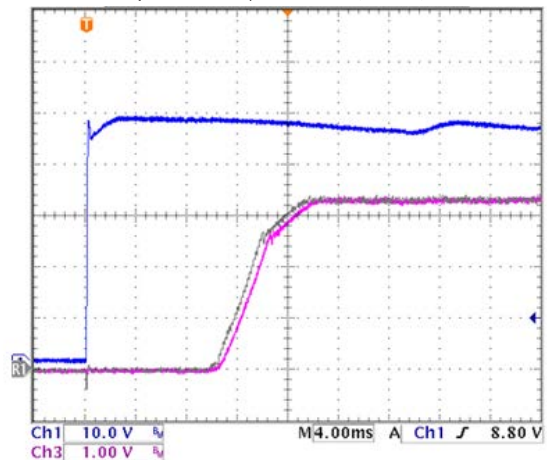

Startup Delay (Vin=48V, Vout=nom, Iout=8A, Cload= 1uF || 10 uF & 2000uF, Ta=+25°C, ScopeBW=20Mhz) Trace 1= Vin, Trace3, Vout.

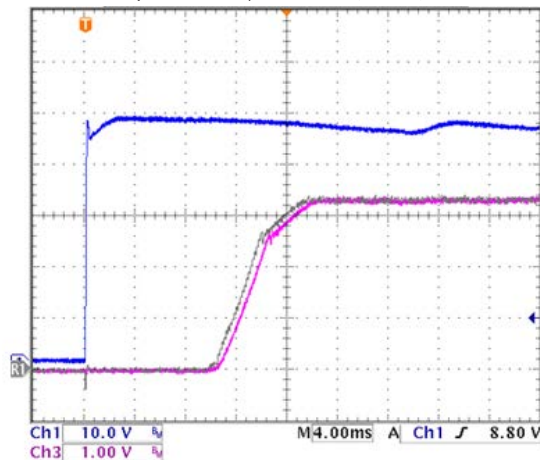

OSCILLOGRAMS, ULS-3.3/8-D48

Step Load Transient Response ($V_{in}=48V$, $V_{out}=nom$, $I_{out}=50-100-50\%$ of full load, $C_{load}=1\mu F \parallel 10\mu F$, $T_a=+25^\circ C$, $ScopeBW=20Mhz$)

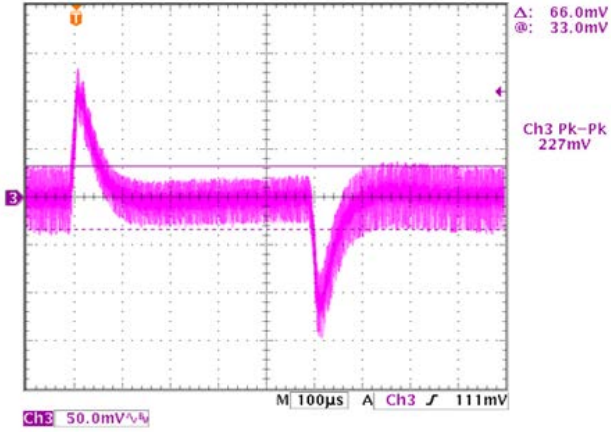

Step Load Transient Response ($V_{in}=48V$, $V_{out}=nom$, $I_{out}=50-75-50\%$ of full load, $C_{load}=1\mu F \parallel 10\mu F$, $T_a=+25^\circ C$, $ScopeBW=20Mhz$)

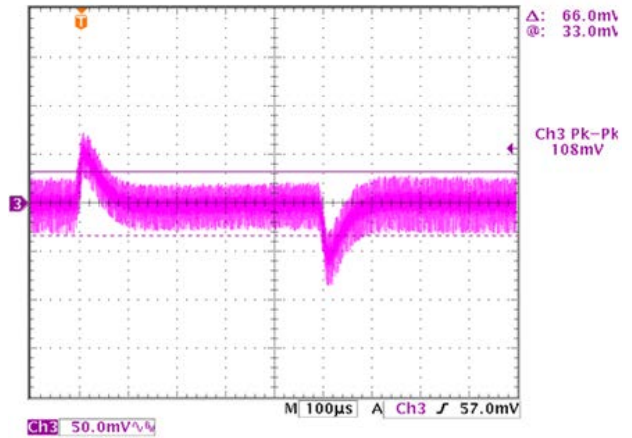

Output Ripple and Noise ($V_{in}=48V$, $V_{out}=nom$, $I_{out}=8A$, $C_{load}=1\mu F \parallel 10\mu F$, $T_a=+25^\circ C$, $ScopeBW=20Mhz$)

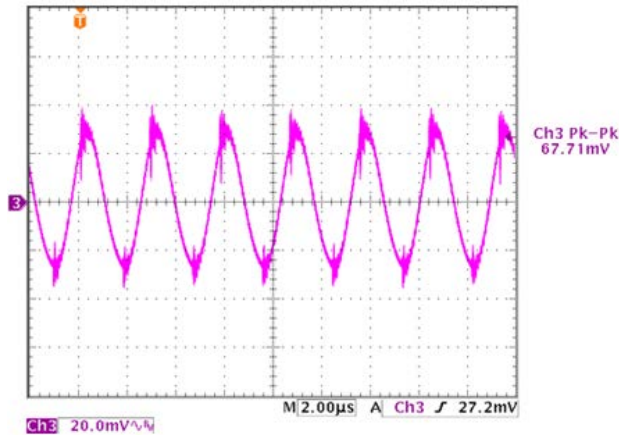

FUNCTIONAL SPECIFICATIONS, ULS-5/6-D48

ABSOLUTE MAXIMUM RATINGS	Conditions ①	Minimum	Typical/Nominal	Maximum	Units
Input Voltage, Continuous		0		80	Vdc
Input Voltage, Transient	100 mS max. duration			100	Vdc
Isolation Voltage	Input to output, continuous			2250	Vdc
Input Reverse Polarity	None, install external fuse		None		Vdc
On/Off Remote Control	Power on, referred to -Vin	0		15	Vdc
Output Power		0		30.3	W
Output Current	Current-limited, no damage, short-circuit protected	0		6	A
Storage Temperature Range	Vin = Zero (no power)	-55		125	°C
Absolute maximums are stress ratings. Exposure of devices to greater than any of these conditions may adversely affect long-term reliability. Proper operation under conditions other than those listed in the Performance/Functional Specifications Table is not implied or recommended.					
INPUT					
Conditions ① ③					
Operating voltage range		36	48	75	Vdc
Recommended External Fuse	Fast blow			2	A
Start-up threshold	Rising input voltage	32.5	35	35.9	Vdc
Undervoltage shutdown	Falling input voltage	31	33.5	34	Vdc
Turn-On/Turn-Off Hysteresis		1.62	1.67	1.72	Vdc
Overvoltage shutdown			None		Vdc
Reverse Polarity Protection	None, install external fuse		None		Vdc
Internal Filter Type			LC		
Input current					
Full Load Conditions	Vin = nominal		0.69	0.71	A
Low Line	Vin = minimum		0.92	0.95	A
Inrush Transient			0.05		A ² -Sec.
Output in Short Circuit			10	100	mA
No Load	Iout = minimum, unit = ON		20	60	mA
Shut-Down Input Current (Off, UV, OT)			1	3	mA
Reflected (back) ripple current ②	Measured at input with specified filter		30		mA, p-p
GENERAL and SAFETY					
Efficiency	Vin = 48V, full load	89	91		%
	Vin = min., full load	89	91		%
Isolation					
Isolation Voltage	Input to output, continuous	2250			Vdc
Insulation Safety Rating			basic		
Isolation Resistance			10		MΩ
Isolation Capacitance			3300		pF
Safety	Certified to UL-60950-1, CSA-C22.2 No. 60950-1, IEC/EN60950-1, 2nd edition		Yes		
Calculated MTBF	Per Telcordia SR332, issue 1, class 3, ground fixed, Tambient = +25°C		TBD		Hours x 10 ⁶
DYNAMIC CHARACTERISTICS					
Fixed Switching Frequency		325	355	385	KHz
Startup Time	Power on to Vout regulated		10	40	mS
Startup Time	Remote ON to Vout regulated		10	40	mS
Dynamic Load Response	50-75-50% load step, settling time to within 1% of Vout		75	100	μSec
Dynamic Load Peak Deviation	same as above		±150		mV
FEATURES and OPTIONS					
Remote On/Off Control ⑤					
"N" suffix:					
Negative Logic, ON state	ON = Ground pin or external voltage	-0.1		0.8	V
Negative Logic, OFF state	OFF = Pin open or external voltage	2.5		15	V
Control Current	Open collector/drain		1		mA
"P" suffix:					
Positive Logic, ON state	ON = Pin open or external voltage	10		15	V
Positive Logic, OFF state	OFF = Ground pin or external voltage	0		0.7	V
Control Current	Open collector/drain		1		mA
SMT Mounting	"M" suffix				

FUNCTIONAL SPECIFICATIONS, ULS-5/6-D48 (CONT.)

OUTPUT	Conditions ①	Minimum	Typical/Nominal	Maximum	Units
Total Output Power		0	30	30.3	W
Voltage					
Nominal Output Voltage	No trim	4.95	5	5.05	Vdc
Setting Accuracy	At 50% load, no trim	-1		1	% of Vnom
Output Voltage Range	User-adjustable	-10		10	% of Vnom.
Overvoltage Protection	Via magnetic feedback	6	6.5	7.2	Vdc
Current					
Output Current Range		0	6	6	A
Minimum Load					
Current Limit Inception	98% of Vnom., after warmup	6.5	7.5	8.25	A
Short Circuit					
Short Circuit Current	Hiccup technique, autorecovery within $\pm 1.25\%$ of Vout			0.3	A
Short Circuit Duration (remove short for recovery)	Output shorted to ground, no damage		Continuous		
Short circuit protection method	Current limiting				
Regulation ⑥					
Line Regulation	Vin = min. to max., Vout = nom., Iout = nom.			± 0.125	% of Vout
Load Regulation	Iout = min. to max., Vin = 48V			± 0.1	% of Vout
Ripple and Noise	5 Hz- 20 MHz BW		75	100	mV pk-pk
Temperature Coefficient	At all outputs		± 0.02		% of Vout./°C
Maximum Capacitive Loading	Low ESR, resistive load only			2000	μ F
MECHANICAL (Through Hole Models)					
Conditions ① ③					
Outline Dimensions			1.30x0.90x0.36		Inches
(Please refer to outline drawing)	LxWxH		33.02x22.86x9.144		mm
Weight			0.58		Ounces
			16.4		Grams
Through Hole Pin Diameter			0.04 & 0.062		Inches
			1.016 & 1.575		mm
Through Hole Pin Material			Copper alloy		
TH Pin Plating Metal and Thickness	Nickel subplate		50		μ -inches
	Gold overplate		5		μ -inches
ENVIRONMENTAL					
Operating Ambient Temperature Range	With Derating	-40		85	°C
Operating Case Temperature Range	No derating, full power, 200lfm, Vertical mount	-40		70	°C
Storage Temperature	Vin = Zero (no power)	-55		125	°C
Thermal Protection/Shutdown	Measured in center	110	115	120	°C
Electromagnetic Interference	External filter is required				
Conducted, EN55022/CISPR22			B		Class
Radiated, EN55022/CISPR22			B		Class
RoHS rating ④			RoHS-6		

Performance Specification Notes

- ① Unless otherwise noted, all specifications are typical at nominal input voltage, nominal output voltage and full load. General conditions are +25° Celsius ambient temperature, near sea level altitude, natural convection airflow. All models are tested and specified with external parallel 1 μ F and 10 μ F multi-layer ceramic output capacitors. The external input capacitor is 22 μ F ceramic. All capacitors are low-ESR types wired close to the converter. These capacitors are necessary for our test equipment and may not be needed in the user's application.
- ② Input (back) ripple current is tested and specified over 5 Hz to 20 MHz bandwidth. Input filtering is Cbus = 220 μ F/100V, Cin = 33 μ F/100V and Lbus = 12 μ H.

- ③ All models are stable and regulate to specification under no load.
- ④ Reduction of Hazardous Substances (RoHS) compliance is to RoHS-6 (six substances restricted including lead). See specifications.
- ⑤ The Remote On/Off Control is referred to -Vin.
- ⑥ Regulation specifications describe the output voltage changes as the line voltage or load current is varied from its nominal or midpoint value to either extreme.

TYPICAL PERFORMANCE CURVES, ULS-5/6-D48

Efficiency vs. Line Voltage and Load Current @ 25°C

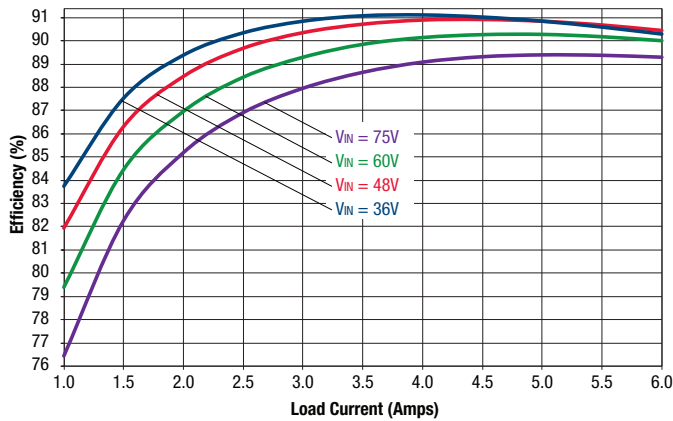

Maximum Current Temperature Derating at Sea Level
(V_{IN} = 36-75V, airflow is from pin 3 to pin 1)

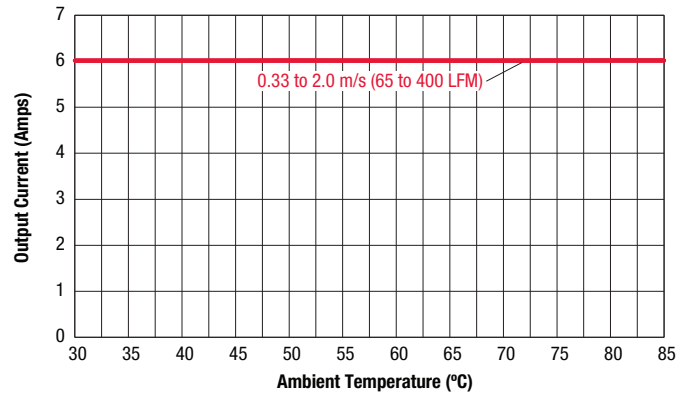

Power Dissipation vs. Load Current @ 25°C

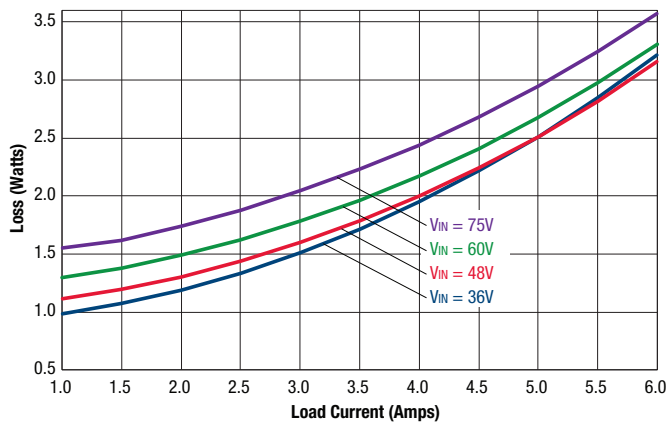

Current Limit

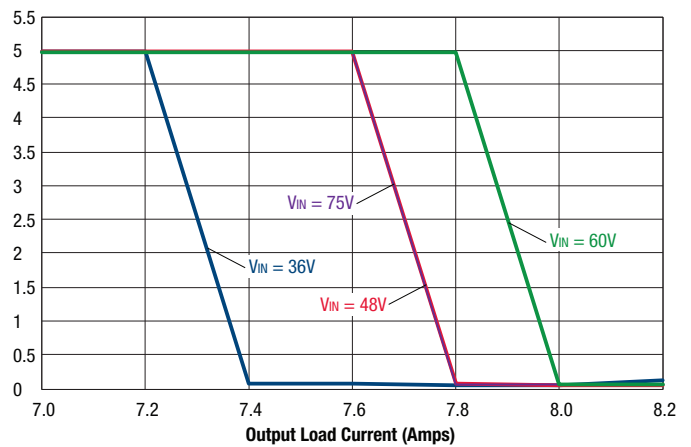

INFRARED THERMAL IMAGE, ULS-5/6-D48

Thermal image with hot spot at full current with 25°C ambient temperature. Natural convection is used with no forced airflow. Identifiable and recommended maximum value to be verified in application. V_{in}=48V, Q7 max temp=120°C/IPC9592 guidelines.

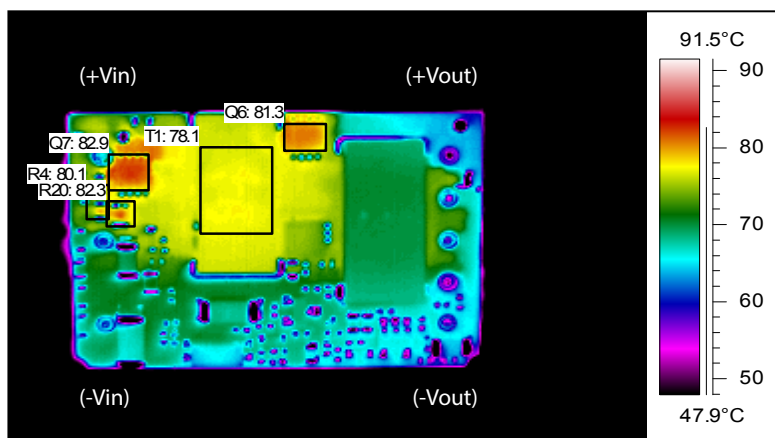

OSCILLOGRAMS, ULS-5/6-D48

Startup Delay (Vin=48V, Iout=6A, Cload=0, Ta=+25°C) Trace1=Vin, Trace4=Vout.

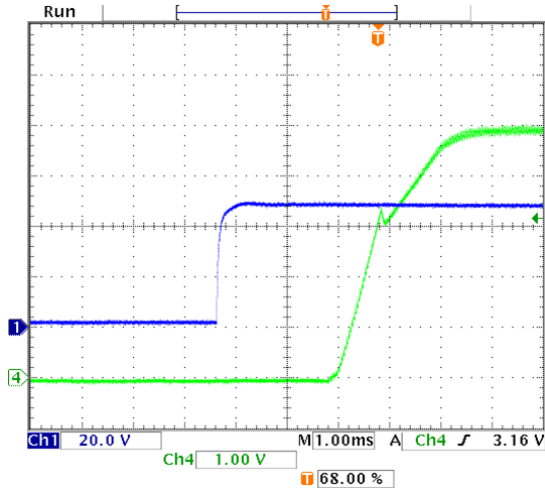

Startup Delay (Vin=48V, Iout=6A, Cload=2200uF, Ta=+25°C) Trace1=Vin, Trace4=Vout

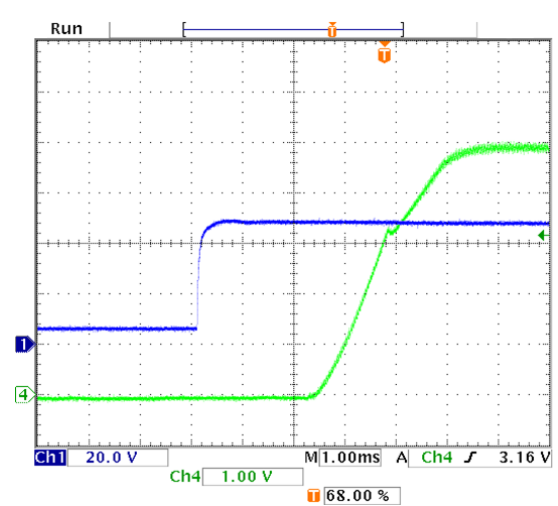

On/Off Enable Delay (Vin=48V, Iout=6A, Cload=0, Ta=+25°C)
Trace1=Enable, Trace4=Vout

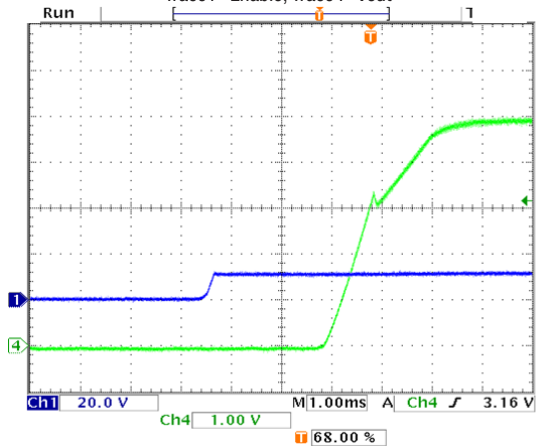

On/Off Enable Delay (Vin=48V, Iout=6A, Cload=2000uF, Ta=+25°C)
Trace1=Enable, Trace4=Vout

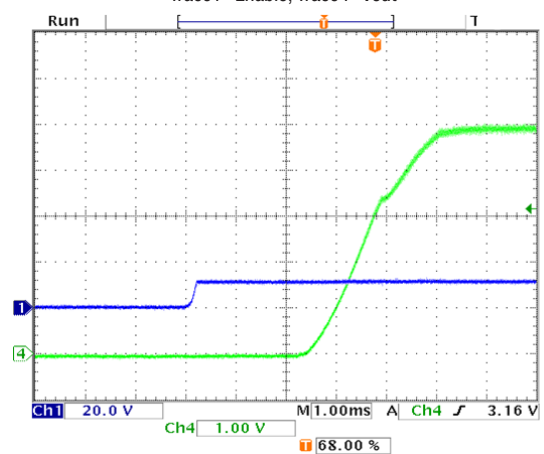

OSCILLOGRAMS, ULS-5/6-D48

Output Ripple and Noise (Vin=48V, Iout=0A, Cload= 1uF || 10uF, Ta=+25°C)

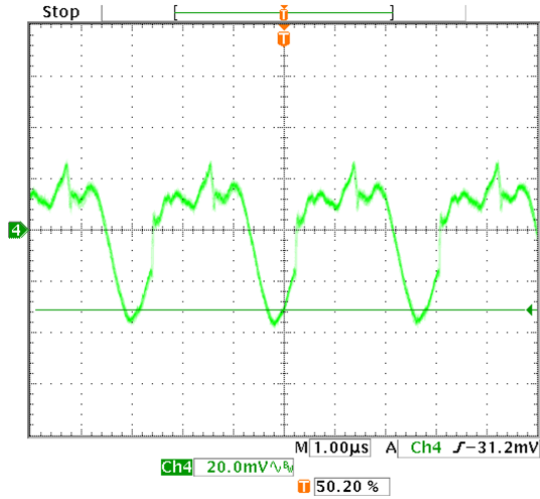

Output Ripple and Noise (Vin=48V, Iout=6A, Cload= 1uF || 10uF, Ta=+25°C)

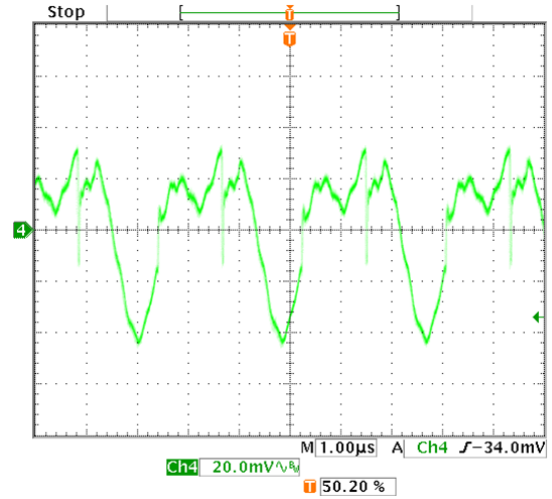

Step Load Transient Response (Vin=48V, Iout=50-75-50% of Imax,
Cload= 1uF || 10uF, Ta=+25°C)

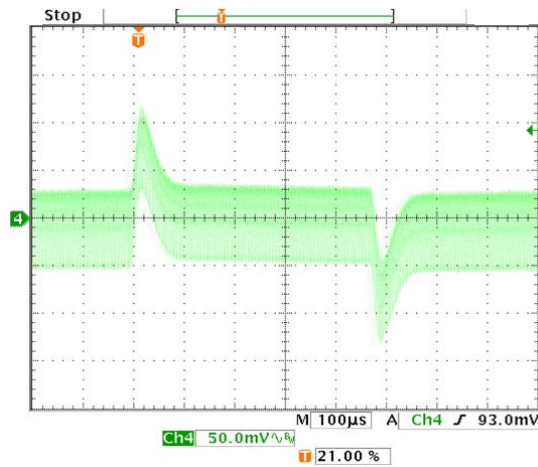

FUNCTIONAL SPECIFICATIONS, ULS-12/2.5-D48

ABSOLUTE MAXIMUM RATINGS	Conditions ①	Minimum	Typical/Nominal	Maximum	Units
Input Voltage, Continuous		0		80	Vdc
Input Voltage, Transient	100 mS max. duration			100	Vdc
Isolation Voltage	Input to output, continuous			2250	Vdc
Input Reverse Polarity	None, install external fuse		None		Vdc
On/Off Remote Control	Power on, referred to -Vin	0		15	Vdc
Output Power		0		30	W
Output Current	Current-limited, no damage, short-circuit protected	0		2.5	A
Storage Temperature Range	Vin = Zero (no power)	-55		125	°C
Absolute maximums are stress ratings. Exposure of devices to greater than any of these conditions may adversely affect long-term reliability. Proper operation under conditions other than those listed in the Performance/Functional Specifications Table is not implied or recommended.					
INPUT					
Conditions ① ③					
Operating voltage range		36	48	75	Vdc
Recommended External Fuse	Fast blow			2	A
Start-up threshold	Rising input voltage	32.5	33.5	35.5	Vdc
Undervoltage shutdown	Falling input voltage	31	32	33	Vdc
Turn-On/Turn-Off Hysteresis		1.40	1.46	1.52	Vdc
Overvoltage shutdown			None		Vdc
Reverse Polarity Protection	None, install external fuse		None		Vdc
Internal Filter Type			Capacitive		
Input current					
Full Load Conditions	Vin = nominal		0.71	0.73	A
Low Line	Vin = minimum		0.95	0.97	A
Inrush Transient			0.05		A ² -Sec.
Output in Short Circuit			100	200	mA
No Load	Iout = minimum, unit = ON		25	50	mA
Shut-Down Input Current (Off, UV, OT)			5	10	mA
Reflected (back) ripple current ②	Measured at input with specified filter		15	30	mA, p-p
GENERAL and SAFETY					
Efficiency	Vin = 48V, full load	86.0	87.7		%
	Vin = min., full load	85.5	87.5		%
Isolation					
Isolation Voltage	Input to output, continuous	2250			Vdc
Insulation Safety Rating			basic		
Isolation Resistance			100		MΩ
Isolation Capacitance			1600		pF
Safety	Certified to UL-60950-1, CSA-C22.2 No. 60950-1, IEC/EN60950-1, 2nd edition		Yes		
Calculated MTBF	Per Telcordia SR332, issue 1, class 3, ground fixed, Tambient = +25°C		3		Hours x 10 ⁶
DYNAMIC CHARACTERISTICS					
Fixed Switching Frequency		260	285	310	KHz
Startup Time	Power on to Vout regulated			30	mS
Startup Time	Remote ON to Vout regulated			30	mS
Dynamic Load Response	50-75-50% load step, settling time to within 1% of Vout		200	300	μSec
Dynamic Load Peak Deviation	same as above		±250	±300	mV
FEATURES and OPTIONS					
Remote On/Off Control ⑤					
"N" suffix:					
Negative Logic, ON state	ON = Ground pin or external voltage	-0.1		0.8	V
Negative Logic, OFF state	OFF = Pin open or external voltage	2.5		15	V
Control Current	Open collector/drain		1	2	mA
"P" suffix:					
Positive Logic, ON state	ON = Pin open or external voltage	10		15	V
Positive Logic, OFF state	OFF = Ground pin or external voltage	0		0.7	V
Control Current	Open collector/drain		1	2	mA
SMT Mounting	"M" suffix				

FUNCTIONAL SPECIFICATIONS, ULS-12/2.5-D48 (CONT.)

OUTPUT	Conditions ①	Minimum	Typical/Nominal	Maximum	Units
Total Output Power	See Derating	0	30	30	W
Voltage					
Nominal Output Voltage	No trim	11.88	12.00	12.12	Vdc
Setting Accuracy	At 50% load, no trim	-1		+1	% of Vnom
Output Voltage Range	User-adjustable	-20		+10	% of Vnom.
Overvoltage Protection	Via magnetic feedback	13.3	15	18	Vdc
Current					
Output Current Range		0.0	2.5	2.5	A
Minimum Load			No minimum load		
Current Limit Inception	98% of Vnom., after warmup	3.3	3.5	4.5	A
Short Circuit					
Short Circuit Current	Hiccup technique, autorecovery within $\pm 1.25\%$ of Vout			40	mA
Short Circuit Duration (remove short for recovery)	Output shorted to ground, no damage		Continuous		
Short circuit protection method	Current limiting				
Regulation ⑥					
Line Regulation	Vin = min. to max., Vout = nom., Iout = nom.			± 0.125	% of Vout
Load Regulation	Iout = min. to max., Vin = 48V			± 0.125	% of Vout
Ripple and Noise	5 Hz- 20 MHz BW		130	150	mV pk-pk
Temperature Coefficient	At all outputs		± 0.02		% of Vout./°C
Maximum Capacitive Loading	Low ESR, resistive load only	0	2200		μ F
MECHANICAL (Through Hole Models)					
Conditions ① ③					
Outline Dimensions			1.30x0.90x0.36		Inches
(Please refer to outline drawing)	LxWxH		33.02x22.86x9.144		mm
Weight			0.58		Ounces
			16.4		Grams
Through Hole Pin Diameter			0.04 & 0.062		Inches
			1.016 & 1.575		mm
Through Hole Pin Material			Copper alloy		
TH Pin Plating Metal and Thickness	Nickel subplate		50		μ -inches
	Gold overplate		5		μ -inches
ENVIRONMENTAL					
Operating Ambient Temperature Range	With Derating	-40		85	°C
Operating Case Temperature Range	No derating, full power	-40		105	°C
Storage Temperature	Vin = Zero (no power)	-55		125	°C
Thermal Protection/Shutdown	Measured in center	115	125	130	°C
Electromagnetic Interference	External filter is required				
Conducted, EN55022/CISPR22			B		Class
Radiated, EN55022/CISPR22			B		Class
Relative humidity, non-condensing	To +85°C	10		90	%RH
Altitude	must derate -1%/1000 feet	-500		10,000	feet
		-152		3048	meters
RoHS rating ④			RoHS-6		

Performance Specification Notes

- ① Unless otherwise noted, all specifications are typical at nominal input voltage, nominal output voltage and full load. General conditions are +25° Celsius ambient temperature, near sea level altitude, natural convection airflow. All models are tested and specified with external parallel 1 μ F and 10 μ F multi-layer ceramic output capacitors. The external input capacitor is 22 μ F ceramic. All capacitors are low-ESR types wired close to the converter. These capacitors are necessary for our test equipment and may not be needed in the user's application.
- ② Input (back) ripple current is tested and specified over 5 Hz to 20 MHz bandwidth. Input filtering is Cbus = 220 μ F/100V, Cin = 33 μ F/100V and Lbus = 12 μ H.

- ③ All models are stable and regulate to specification under no load.
- ④ Reduction of Hazardous Substances (RoHS) compliance is to RoHS-6 (six substances restricted including lead). See specifications.
- ⑤ The Remote On/Off Control is referred to -Vin.
- ⑥ Regulation specifications describe the output voltage changes as the line voltage or load current is varied from its nominal or midpoint value to either extreme.

TYPICAL PERFORMANCE CURVES, ULS-12/2.5-D48

Efficiency vs. Line Voltage and Load Current @ 25°C

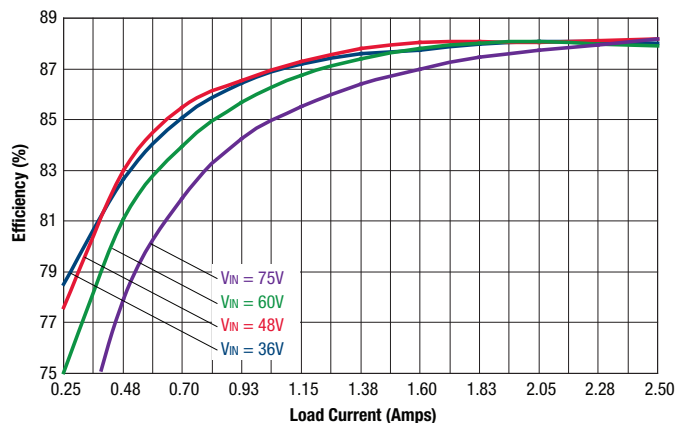

Power Dissipation vs. Load Current @ 25°C

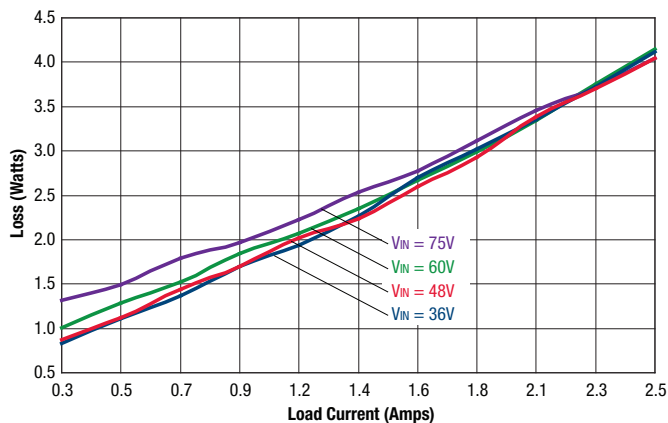

Maximum Current Temperature Derating at Sea Level
(VIN = 36V, 48V, and 75V, airflow is from pin 3 to pin 1)

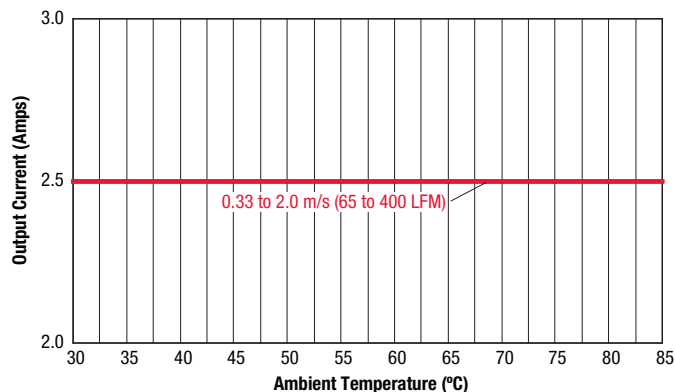

Maximum Current Temperature Derating at Sea Level
(VIN = 60V, airflow is from pin 3 to pin 1)

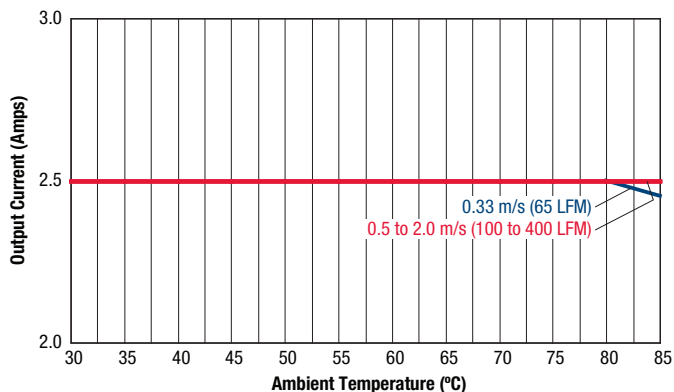

INFRARED THERMAL IMAGE, ULS-12/2.5-D48

Thermal image with hot spot at full load current with 25 °C ambient temperature. Natural convection is used with no forced airflow. Identifiable and recommended maximum value to be verified in application. Vin=48V, Q6 max Temp=120 °C/IPC9592 guidelines.

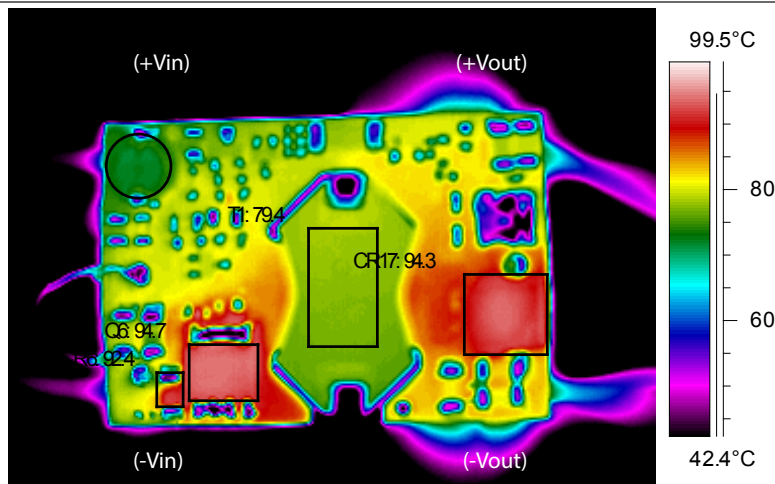

OSCILLOGRAMS, ULS-12/2.5-D48

On/Off Enable Delay (Vin = 48V, Vout = nom., Iout = 2.5A, Cload = 0 μ F, Ta = +25°C.,
ScopeBW = 20MHz) Trace 1 = Enable, Trace 4 = Vout

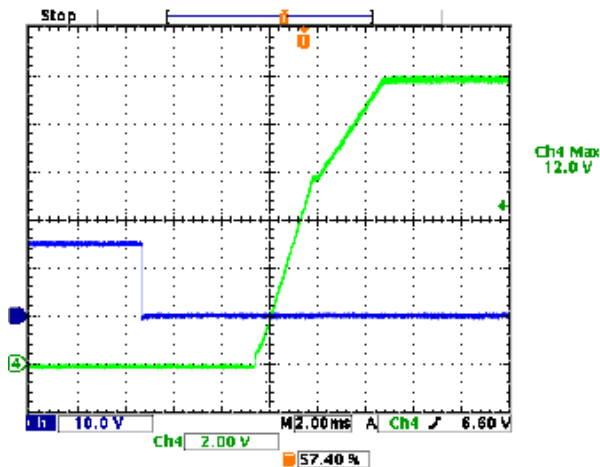

Power On Startup Delay (Vin = 48V, Vout = nom., Iout = 2.5A, Cload = 0 μ F, Ta = +25°C.,
ScopeBW = 20MHz) Trace 1 = Vin, Trace 4 = Vout

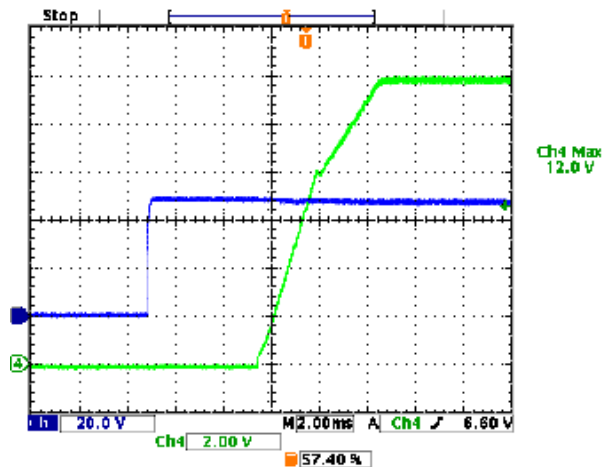

Step Load Transient Response (Vin = 48V, Vout = nom., Iout = 50-75-50% of full load,
Cload = 1 μ F ceramic || 10 μ F tantalum, Ta = +25°C., ScopeBW = 20MHz)

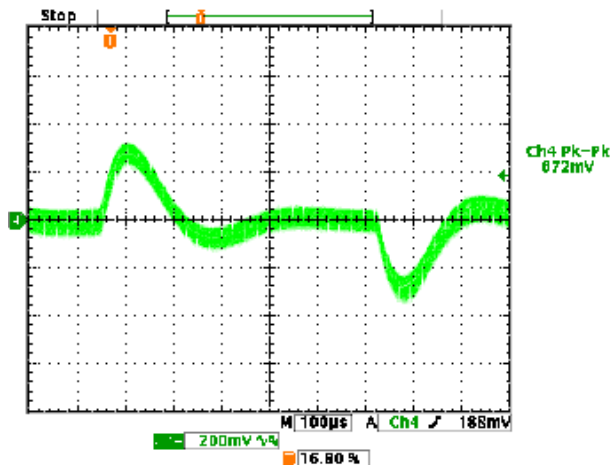

Output Ripple and Noise (Vin = 48V, Vout = nom., Iout = no load, Cload = 1 μ F ceramic ||
10 μ F tantalum, Ta = +25°C., ScopeBW = 20MHz)

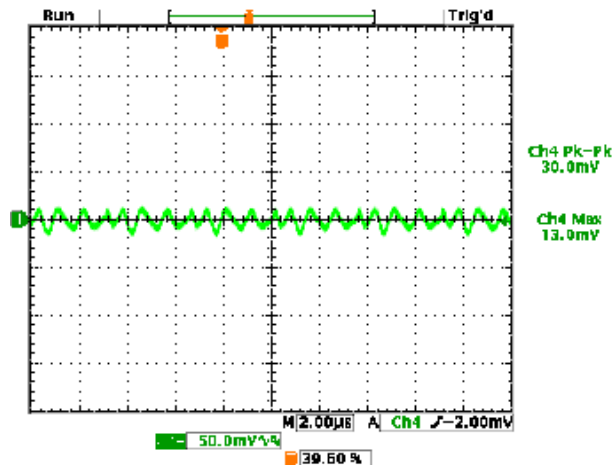

Output Ripple and Noise (Vin = 48V, Vout = nom., Iout = 2.5A, Cload = 1 μ F ceramic || 10 μ F
tantalum, Ta = +25°C., ScopeBW = 20MHz)

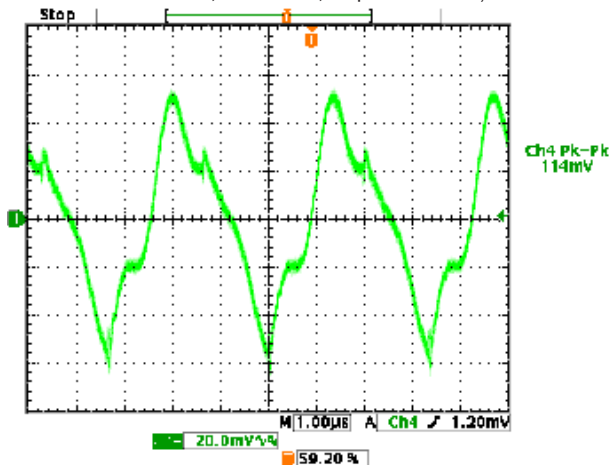

FUNCTIONAL SPECIFICATIONS, ULS-15/2-D48

ABSOLUTE MAXIMUM RATINGS	Conditions ①	Minimum	Typical/Nominal	Maximum	Units
Input Voltage, Continuous		0		80	Vdc
Input Voltage, Transient	100 mS max. duration			100	Vdc
Isolation Voltage	Input to output, continuous			2250	Vdc
Input Reverse Polarity	None, install external fuse		None		Vdc
On/Off Remote Control	Power on, referred to -Vin	0		15	Vdc
Output Power		0		30	W
Output Current	Current-limited, no damage, short-circuit protected	0		2	A
Storage Temperature Range	Vin = Zero (no power)	-55		125	°C
Absolute maximums are stress ratings. Exposure of devices to greater than any of these conditions may adversely affect long-term reliability. Proper operation under conditions other than those listed in the Performance/Functional Specifications Table is not implied or recommended.					
INPUT					
Conditions ① ③					
Operating voltage range		36	48	75	Vdc
Recommended External Fuse	Fast blow			2	A
Start-up threshold	Rising input voltage	32.5	33.5	35.5	Vdc
Undervoltage shutdown	Falling input voltage	31	32	33	Vdc
Turn-On/Turn-Off Hysteresis		1.42	1.48	1.52	Vdc
Overvoltage shutdown			None		Vdc
Reverse Polarity Protection	None, install external fuse		None		Vdc
Internal Filter Type			Capacitive		
Input current					
Full Load Conditions	Vin = nominal		0.7	0.714	A
Low Line	Vin = minimum		0.94	0.95	A
Inrush Transient			0.05		A ² -Sec.
Output in Short Circuit			100	200	mA
No Load	Iout = minimum, unit = ON		25	50	mA
Shut-Down Input Current (Off, UV, OT)			5	10	mA
Reflected (back) ripple current ②	Measured at input with specified filter		15	30	mA, p-p
GENERAL and SAFETY					
Efficiency	Vin = 48V, full load	87.5	89.0		%
	Vin = min., full load	87.5	89.0		%
Isolation					
Isolation Voltage	Input to output, continuous	2250			Vdc
Insulation Safety Rating			basic		
Isolation Resistance			100		MΩ
Isolation Capacitance			1600		pF
Safety	Certified to UL-60950-1, CSA-C22.2 No.60950-1, IEC/EN60950-1, 2nd edition		Yes		
Calculated MTBF	Per Telcordia SR332, issue 1, class 3, ground fixed, Tambient = +25°C		3		Hours x 10 ⁶
DYNAMIC CHARACTERISTICS					
Fixed Switching Frequency		280	290	310	KHz
Startup Time	Power on to Vout regulated			30	mS
Startup Time	Remote ON to Vout regulated			30	mS
Dynamic Load Response	50-75-50% load step, settling time to within 1% of Vout		200	300	μSec
Dynamic Load Peak Deviation	same as above		±250	±300	mV
FEATURES and OPTIONS					
Remote On/Off Control ⑤					
"N" suffix:					
Negative Logic, ON state	ON = Ground pin or external voltage	-0.1		0.8	V
Negative Logic, OFF state	OFF = Pin open or external voltage	2.5		15	V
Control Current	Open collector/drain		1	2	mA
"P" suffix:					
Positive Logic, ON state	ON = Pin open or external voltage	10		15	V
Positive Logic, OFF state	OFF = Ground pin or external voltage	0		0.7	V
Control Current	Open collector/drain		1	2	mA
SMT Mounting	"M" suffix				

FUNCTIONAL SPECIFICATIONS, ULS-15/2-D48 (CONT.)

OUTPUT	Conditions ①	Minimum	Typical/Nominal	Maximum	Units
Total Output Power	See Derating	0	30	30	W
Voltage					
Nominal Output Voltage	No trim	14.85	15.00	15.15	Vdc
Setting Accuracy	At 50% load, no trim	-1		+1	% of Vnom
Output Voltage Range	User-adjustable	-20		+10	% of Vnom.
Overvoltage Protection	Via magnetic feedback	18	19	20	Vdc
Current					
Output Current Range		0.0	2.0	2.0	A
Minimum Load			No minimum load		
Current Limit Inception	98% of Vnom., after warmup	2.45	3.0	3.45	A
Short Circuit					
Short Circuit Current	Hiccup technique, autorecovery within $\pm 1.25\%$ of Vout			0.6	A
Short Circuit Duration (remove short for recovery)	Output shorted to ground, no damage		Continuous		
Short circuit protection method	Current limiting				
Regulation ⑥					
Line Regulation	Vin = min. to max., Vout = nom., Iout = nom.			± 0.125	% of Vout
Load Regulation	Iout = min. to max., Vin = 48V			± 0.125	% of Vout
Ripple and Noise	5 Hz- 20 MHz BW		115	125	mV pk-pk
Temperature Coefficient	At all outputs		± 0.02		% of Vout./°C
Maximum Capacitive Loading	Low ESR, resistive load only	0	2200		μF
MECHANICAL (Through Hole Models)					
Conditions ① ③					
Outline Dimensions			1.30x0.90x0.36		Inches
(Please refer to outline drawing)	LxWxH		33.02x22.86x9.144		mm
Weight			0.58		Ounces
			16.4		Grams
Through Hole Pin Diameter			0.04 & 0.062		Inches
			1.016 & 1.575		mm
Through Hole Pin Material			Copper alloy		
TH Pin Plating Metal and Thickness	Nickel subplate		50		μ -inches
	Gold overplate		5		μ -inches
ENVIRONMENTAL					
Operating Ambient Temperature Range	With Derating	-40		85	°C
Operating Case Temperature Range	No derating, full power	-40		105	°C
Storage Temperature	Vin = Zero (no power)	-55		125	°C
Thermal Protection/Shutdown	Measured in center	115	125	130	°C
Electromagnetic Interference	External filter is required				
Conducted, EN55022/CISPR22			B		Class
Radiated, EN55022/CISPR22			B		Class
Relative humidity, non-condensing	To +85°C	10		90	%RH
Altitude	must derate -1%/1000 feet	-500		10,000	feet
		-152		3048	meters
RoHS rating ④			RoHS-6		

Performance Specification Notes

- ① Unless otherwise noted, all specifications are typical at nominal input voltage, nominal output voltage and full load. General conditions are +25° Celsius ambient temperature, near sea level altitude, natural convection airflow. All models are tested and specified with external parallel 1 μF and 10 μF multi-layer ceramic output capacitors. The external input capacitor is 22 μF ceramic. All capacitors are low-ESR types wired close to the converter. These capacitors are necessary for our test equipment and may not be needed in the user's application.
- ② Input (back) ripple current is tested and specified over 5 Hz to 20 MHz bandwidth. Input filtering is $C_{bus} = 220 \mu\text{F}/100\text{V}$, $C_{in} = 33 \mu\text{F}/100\text{V}$ and $L_{bus} = 12 \mu\text{H}$.

- ③ All models are stable and regulate to specification under no load.
- ④ Reduction of Hazardous Substances (RoHS) compliance is to RoHS-6 (six substances restricted including lead). See specifications.
- ⑤ The Remote On/Off Control is referred to -Vin.
- ⑥ Regulation specifications describe the output voltage changes as the line voltage or load current is varied from its nominal or midpoint value to either extreme.

TYPICAL PERFORMANCE CURVES, ULS-15/2-D48

Efficiency vs. Line Voltage and Load Current @ 25°C

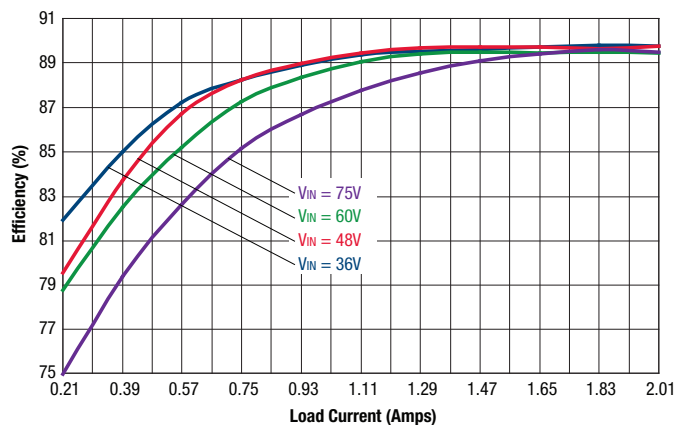

Power Dissipation vs. Load Current @ 25°C

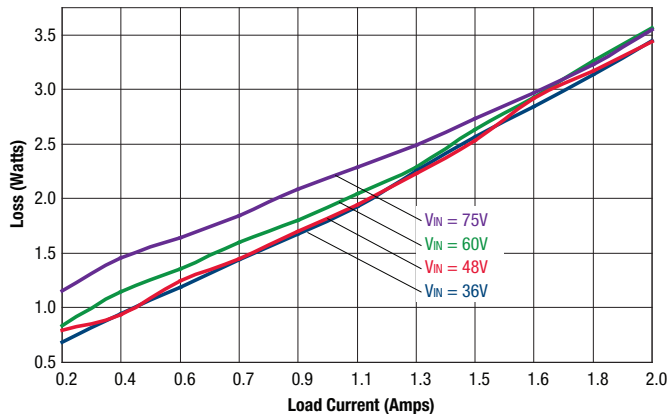

Maximum Current Temperature Derating at Sea Level
(VIN = 36V, 48V, 60V, and 75V, airflow is from pin 3 to pin 1)

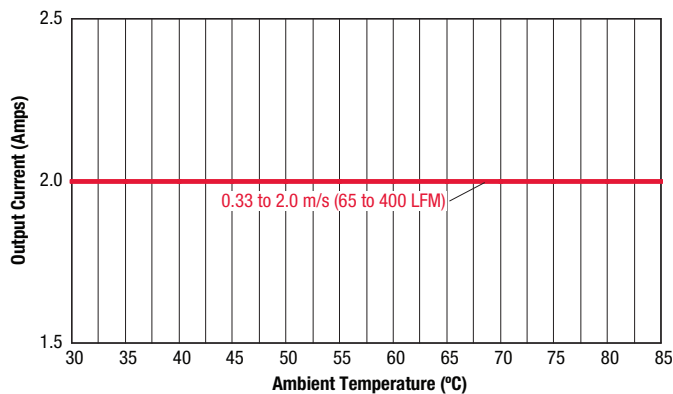

INFRARED THERMAL IMAGE, ULS-15/2-D48

Thermal image with hot spot at full load current with 25 °C ambient temperature. Natural convection is used with no forced airflow. Identifiable and recommended maximum value to be verified in application. Vin=48V, Q6 max Temp=120 °C/IPC9592 guidelines.

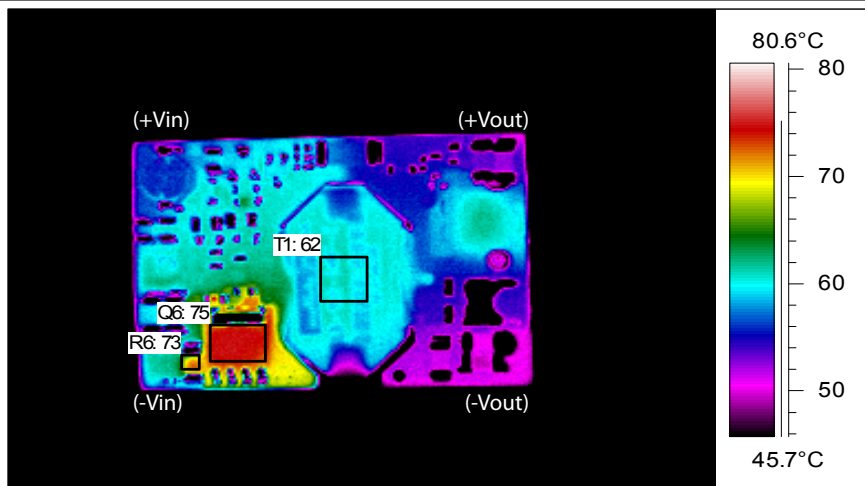

OSCILLOGRAMS, ULS-15/2-D48

On/Off Enable Delay (Vin = 48V, Vout = nom., Iout = 2A, Cload = 0 μ F, Ta = +25°C.,
ScopeBW = 20MHz) Trace 1 = Enable, Trace 4 = Vout

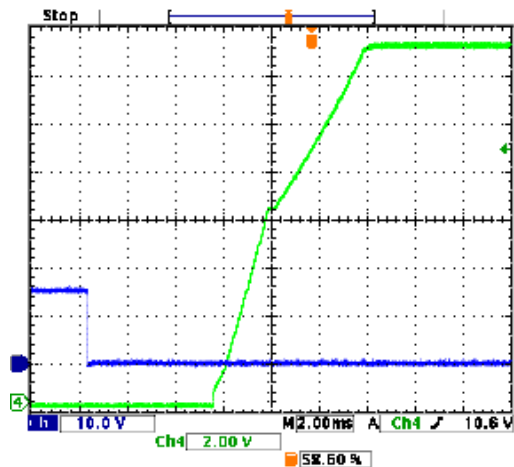

Power On Startup Delay (Vin = 48V, Vout = nom., Iout = 2A, Cload = 0 μ F, Ta = +25°C.,
ScopeBW = 20MHz) Trace 1 = Vin, Trace 4 = Vout

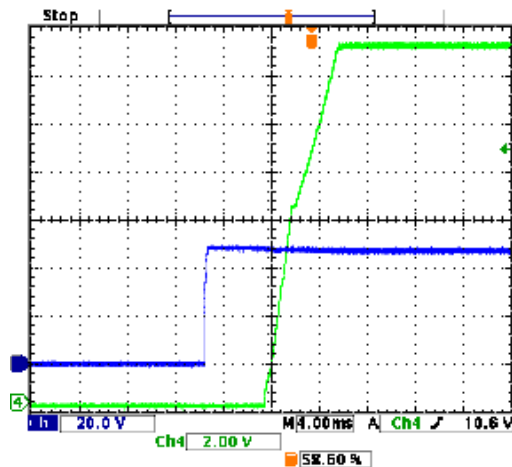

Step Load Transient Response (Vin = 48V, Vout = nom., Iout = 50-75-50% of full load,
Cload = 1 μ F ceramic || 10 μ F tantalum, Ta = +25°C., ScopeBW = 20MHz)

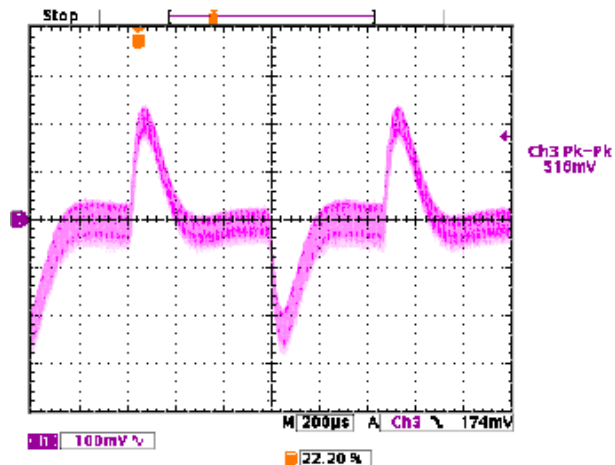

Output Ripple and Noise (Vin = 48V, Vout = nom., Iout = no load, Cload = 1 μ F ceramic ||
10 μ F tantalum, Ta = +25°C., ScopeBW = 20MHz)

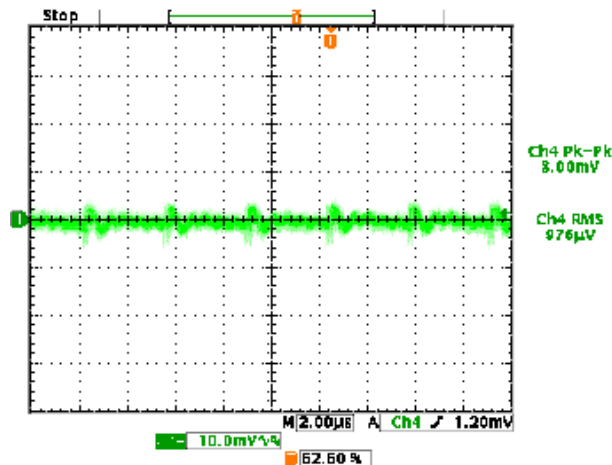

Output Ripple and Noise (Vin = 48V, Vout = nom., Iout = 2A, Cload = 1 μ F ceramic || 10 μ F
tantalum, Ta = +25°C., ScopeBW = 20MHz)

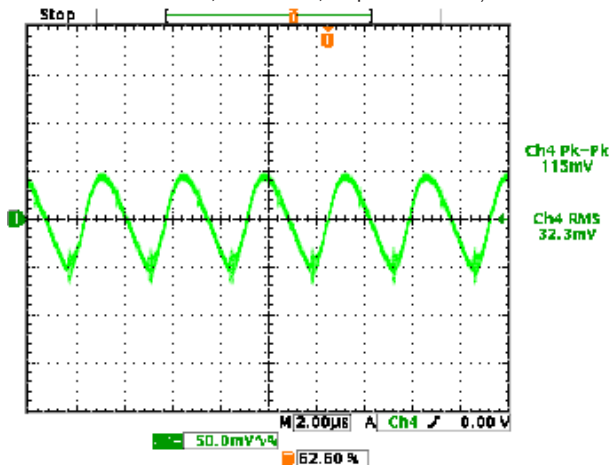

MECHANICAL SPECIFICATIONS, THROUGH-HOLE MOUNT

SIDE VIEW

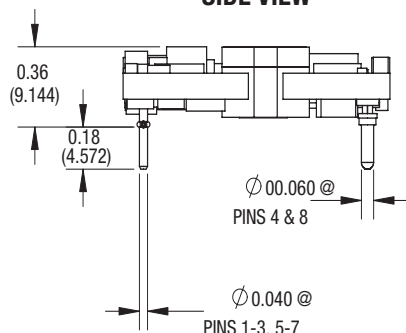

END VIEW

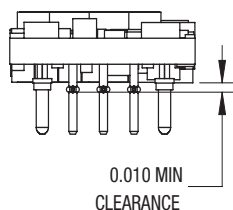

MATERIAL:
 \varnothing .040 PINS: COPPER ALLOY
 \varnothing .062 PINS: COPPER ALLOY

FINISH: (ALL PINS)
 GOLD (5u" MIN) OVER NICKEL (50u" MIN)

BOTTOM PIN VIEW

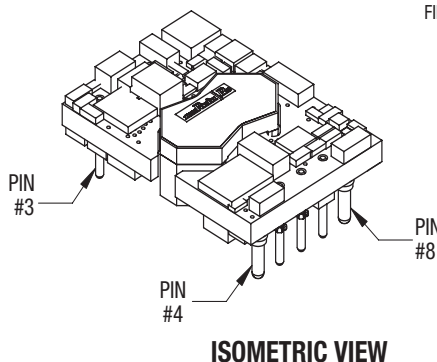
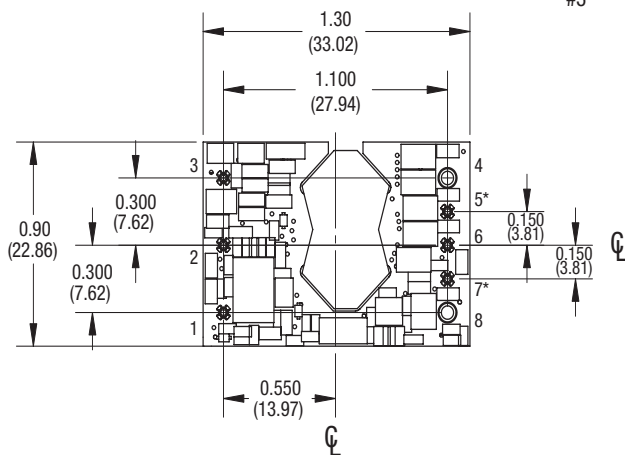

ISOMETRIC VIEW

INPUT/OUTPUT CONNECTIONS P75

Pin	Function	Pin	Function
3	-Vin	4	-Vout
		5	(-)Sense
2	On/Off Control	6	Trim
		7	(+)Sense
1	+Vin	8	+Vout

*Sense is included on the ULS-3.3/8-D48 and ULS-5/6-D48 only.

The 0.18-inch pin length is shown. Please refer to the part number structure for alternate pin lengths.
 Pin material: Copper alloy. Plating: Gold over nickel

Please note that some competitive units may use different pin numbering or alternate outline views; however, all units are plugin-compatible.

It is recommended that no parts be placed beneath the converter.

Dimensions are in inches (mm shown for ref. only).

**Recommended Footprint
(View Through Converter)**

Top View

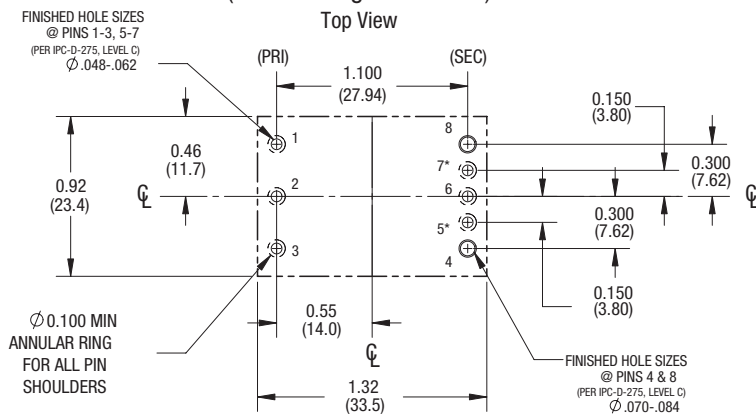

It is recommended that no parts be placed beneath converter

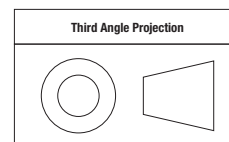

Tolerances (unless otherwise specified):
 .XX ± 0.02 (0.5)
 .XXX ± 0.010 (0.25)
 Angles ± 2°

Components are shown for reference only.

MECHANICAL SPECIFICATIONS, SURFACE MOUNT (MSL RATING 2)

SIDE VIEW

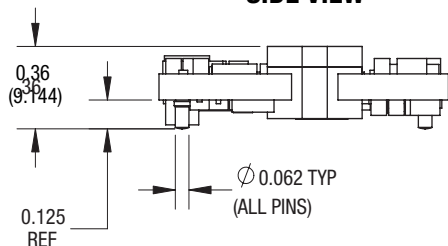

END VIEW

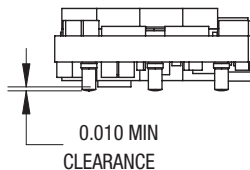

MATERIAL:
SMT CONTACTS: COPPER ALLOY

FINISH: (ALL PINS)
GOLD (5u"MIN) OVER NICKEL (50u" MIN)

BOTTOM PIN VIEW

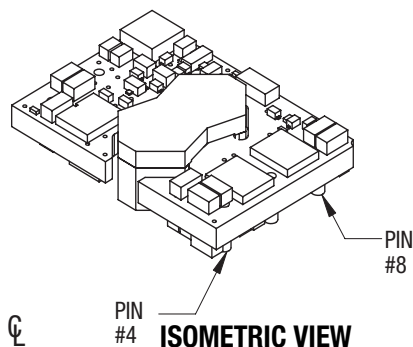
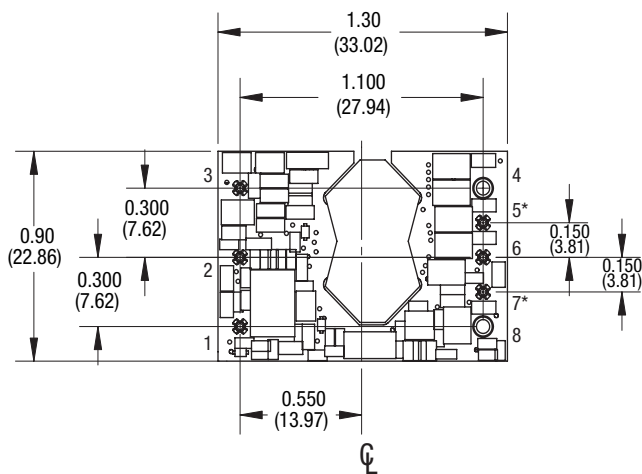

ISOMETRIC VIEW

INPUT/OUTPUT CONNECTIONS P75

Pin	Function	Pin	Function
3	-Vin	4	-Vout
		5	(-)Sense
2	On/Off Control	6	Trim
		7	(+)Sense
1	+Vin	8	+Vout

Please note that some competitive units may use different pin numbering or alternate outline views; however, all units are plugin-compatible.

It is recommended that no parts be placed beneath the converter.

Sense is included on the ULS-3.3/8-D48 and ULS-5/6-D48 only.

Dimensions are in inches (mm shown for ref. only).

**Recommended Footprint
(View Through Converter)**

Top View

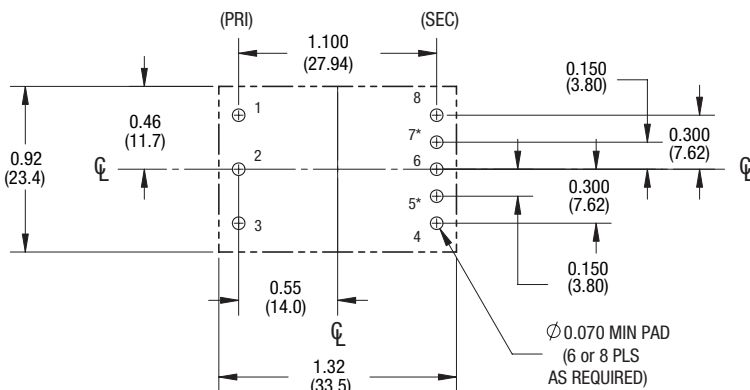

It is recommended that no parts be placed beneath converter

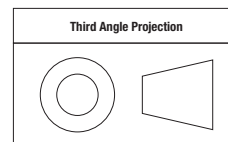

Tolerances (unless otherwise specified):
.XX ± 0.02 (0.5)
.XXX ± 0.010 (0.25)
Angles ± 2'

Components are shown for reference only.

SHIPPING TRAYS AND BOXES, THROUGH-HOLE MOUNT

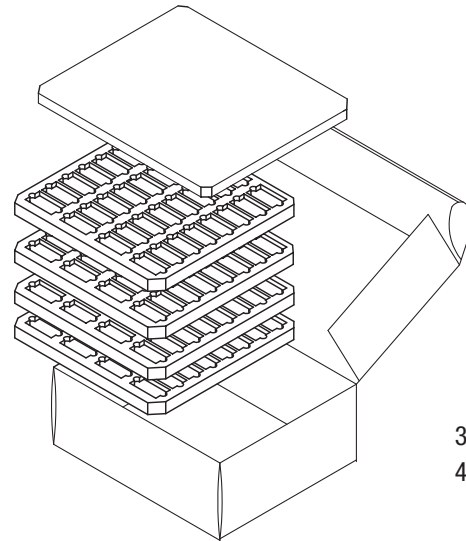
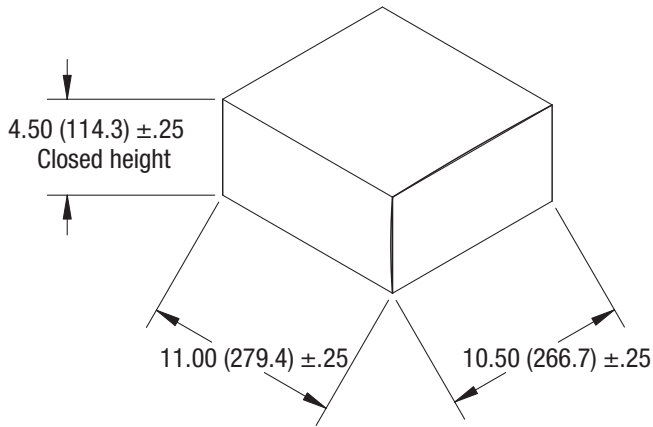

32 units per tray
4 trays per box

Each static dissipative polyethylene foam tray accommodates 32 converters in a 4 x 8 array.

SHIPPING TRAY DIMENSIONS

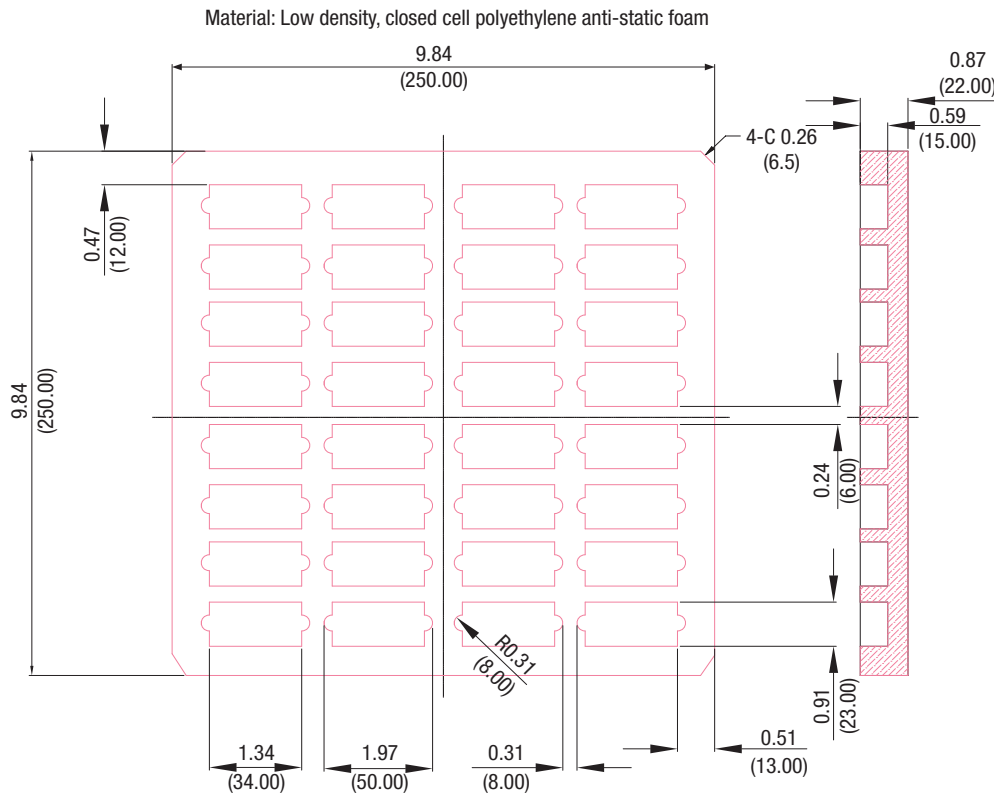

Dimensions are in inches (mm shown for ref. only).

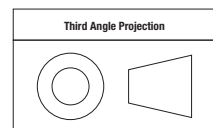

Tolerances (unless otherwise specified):

.XX ± 0.02 (0.5)

.XXX ± 0.010 (0.25)

Angles ± 1°

Components are shown for reference only.

TAPE AND REEL INFORMATION (MSL RATING 2)

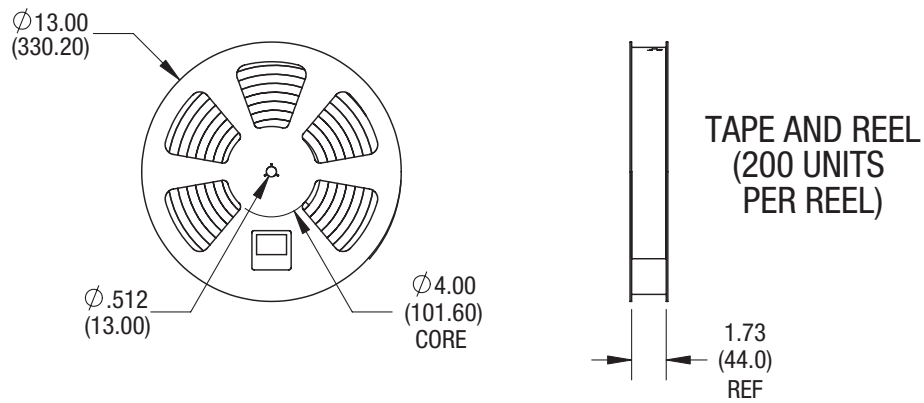
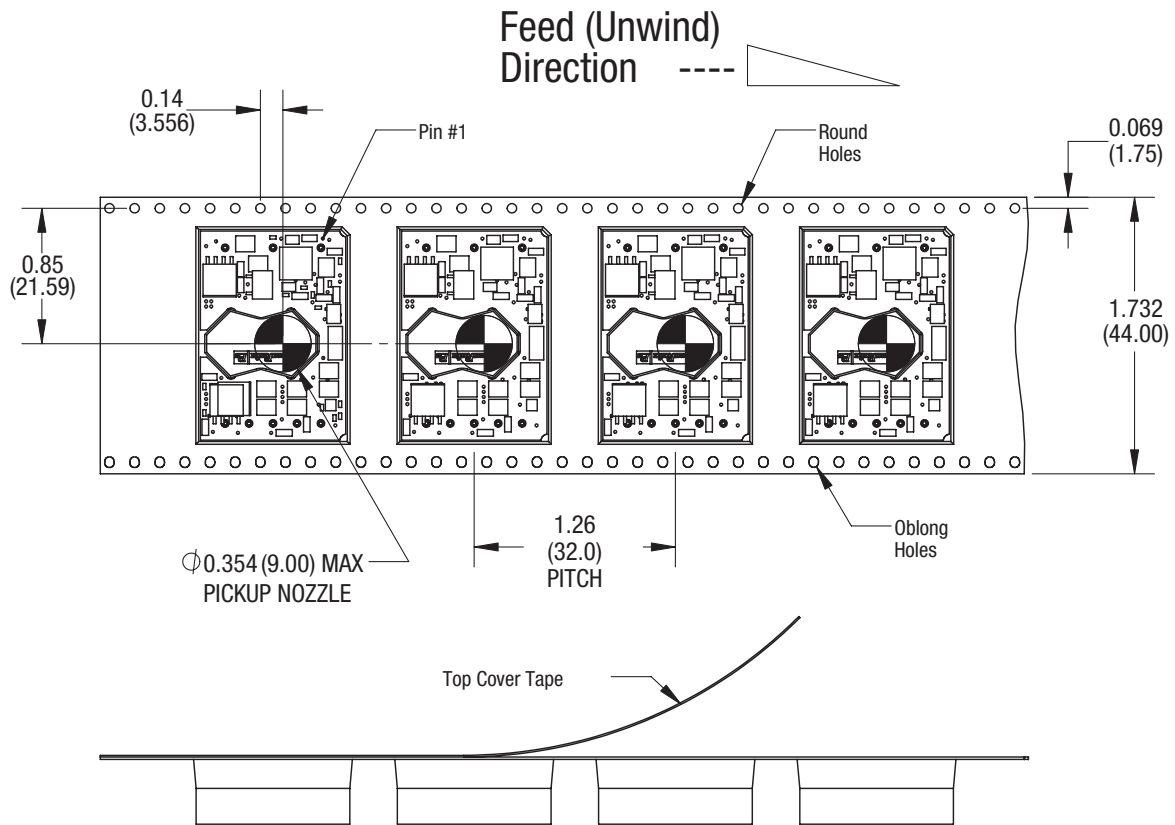

Dimensions are in inches (mm shown for ref. only).

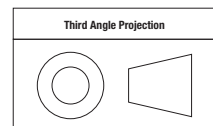

Tolerances (unless otherwise specified):
 .XX ± 0.02 (0.5)
 .XXX ± 0.010 (0.25)
 Angles ± 1°

Components are shown for reference only.

TECHNICAL NOTES

Input Fusing

Certain applications and/or safety agencies may require the installation of fuses at the inputs of power conversion components. Fuses should also be used if the possibility of sustained, non-current-limited, input-voltage polarity reversals exists. For DATEL ULS series DC/DC converters, we recommend the use of a fast blow fuse, installed in the ungrounded input supply line with a typical value about twice the maximum input current, calculated at low line with the converter's minimum efficiency.

All relevant national and international safety standards and regulations must be observed by the installer. For system safety agency approvals, the converters must be installed in compliance with the requirements of the end-use safety standard, i.e. IEC/EN/UL60950-1.

Input Reverse-Polarity Protection

If the input voltage polarity is accidentally reversed, an internal diode will become forward biased and likely draw excessive current from the power source. If this source is not current limited or the circuit appropriately fused, it could cause permanent damage to the converter.

Input Under-Voltage Shutdown and Start-Up Threshold

Under normal start-up conditions, devices will not begin to regulate properly until the ramping-up input voltage exceeds the Start-Up Threshold Voltage. Once operating, devices will not turn off until the input voltage drops below the Under-Voltage Shutdown limit. Subsequent re-start will not occur until the input is brought back up to the Start-Up Threshold. This built in hysteresis prevents any unstable on/off situations from occurring at a single input voltage.

Start-Up Time

The V_{IN} to V_{OUT} Start-Up Time is the time interval between the point at which the ramping input voltage crosses the Start-Up Threshold and the fully loaded output voltage enters and remains within its specified accuracy band. Actual measured times will vary with input source impedance, external input capacitance, and the slew rate and final value of the input voltage as it appears at the converter. The ULS Series implements a soft start circuit to limit the duty cycle of its PWM controller at power up, thereby limiting the input inrush current.

The On/Off Control to V_{OUT} start-up time assumes the converter has its nominal input voltage applied but is turned off via the On/Off Control pin. The specification defines the interval between the point at which the converter is turned on (released) and the fully loaded output voltage enters and remains within its specified accuracy band. Similar to the V_{IN} to V_{OUT} start-up, the On/Off Control to V_{OUT} start-up time is also governed by the internal soft start circuitry and external load capacitance. The difference in start up time from V_{IN} to V_{OUT} and from On/Off Control to V_{OUT} is therefore insignificant.

Input Source Impedance

The input of ULS converters must be driven from a low ac-impedance source. The DC/DC's performance and stability can be compromised by the use of highly inductive source impedances. The input circuit shown in Figure 2 is a practical solution that can be used to minimize the effects of inductance in the input traces. For optimum performance, components should be mounted close to the DC/DC converter.

I/O Filtering, Input Ripple Current, and Output Noise

All models in the ULS Series are tested/specified for input reflected ripple current and output noise using the specified external input/output components/circuits and layout as shown in the following two figures. External input capacitors (C_{IN} in Figure 2) serve primarily as energy-storage elements, minimizing line voltage variations caused by transient IR drops in conductors from backplane to the DC/DC. Input caps should be selected for bulk capacitance (at appropriate frequencies), low ESR, and high rms-ripple-current ratings. The switching nature of DC/DC converters requires that dc voltage sources have low ac impedance as highly inductive source impedance can affect system stability. In Figure 2, C_{BUS} and L_{BUS} simulate a typical dc voltage bus. Your specific system configuration may necessitate additional considerations.

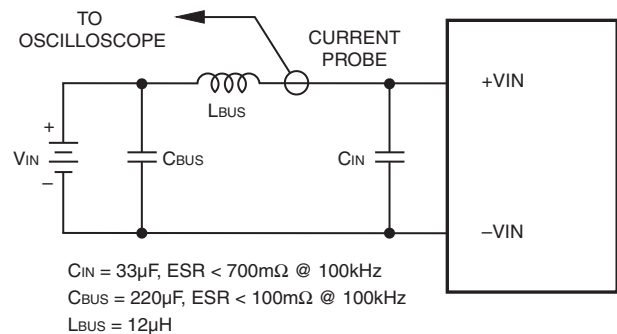

Figure 2. Measuring Input Ripple Current

In critical applications, output ripple/noise (also referred to as periodic and random deviations or PARD) may be reduced below specified limits using filtering techniques, the simplest of which is the installation of additional external output capacitors. They function as true filter elements and should be selected for bulk capacitance, low ESR and appropriate frequency response.

All external capacitors should have appropriate voltage ratings and be located as close to the converter as possible. Temperature variations for all relevant parameters should also be taken carefully into consideration. The most effective combination of external I/O capacitors will be a function of line voltage and source impedance, as well as particular load and layout conditions.

Floating Outputs

Since these are isolated DC/DC converters, their outputs are “floating” with respect to their input. Designers will normally use the -Output as the ground/return of the load circuit. You can however, use the +Output as ground/return to effectively reverse the output polarity.

Minimum Output Loading Requirements

ULS converters employ a synchronous-rectifier design topology and all models regulate within spec and are stable under no-load to full load conditions. Operation under no-load conditions however might slightly increase the output ripple and noise.

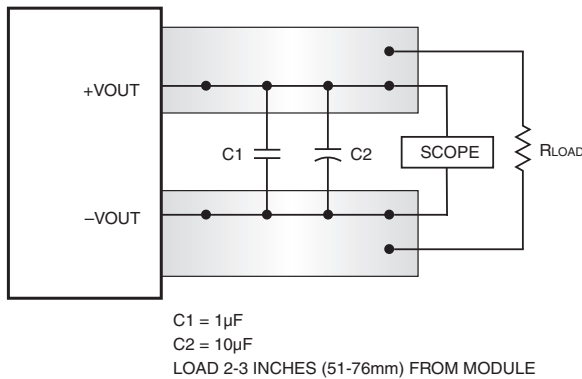

Figure 3. Measuring Output Ripple/Noise (PARD)

Thermal Shutdown

The ULS converters are equipped with thermal-shutdown circuitry. If environmental conditions cause the temperature of the DC/DC converter to rise above the designed operating temperature, a precision temperature sensor will power down the unit. When the internal temperature decreases below the threshold of the temperature sensor, the unit will self start. See Performance/Functional Specifications.

Output Over-Voltage Protection

The ULS output voltage is monitored for an over-voltage condition using a comparator. The signal is optically coupled to the primary side and if the output voltage rises to a level which could be damaging to the load, the sensing circuitry will power down the PWM controller causing the output voltage to decrease. Following a time-out period the PWM will restart, causing the output voltage to ramp to its appropriate value. If the fault condition persists, and the output voltage again climbs to excessive levels, the over-voltage circuitry will initiate another shutdown cycle. This on/off cycling is referred to as "hiccup" mode.

Current Limiting

As soon as the output current increases to approximately 130% of its rated value, the DC/DC converter will go into a current-limiting mode. In this condition, the output voltage will decrease proportionately with increases in output current, thereby maintaining somewhat constant power dissipation. This is commonly referred to as power limiting. Current limit inception is defined as the point at which the full-power output voltage falls below the specified tolerance. See Performance/Functional Specifications. If the load current, being drawn from the converter, is significant enough, the unit will go into a short circuit condition as described below.

Short Circuit Condition

When a converter is in current-limit mode, the output voltage will drop as the output current demand increases. If the output voltage drops too low, the magnetically coupled voltage used to develop primary side voltages will also drop, thereby shutting down the PWM controller. Following a time-out period, the PWM will restart causing the output voltage to begin ramping to their appropriate value. If the short-circuit condition persists, another shutdown cycle will be initiated. This on/off cycling is referred to as "hiccup" mode. The hiccup cycling reduces the average output current, thereby preventing internal temperatures from rising to excessive levels. The ULS Series is capable of enduring an indefinite short circuit output condition.

On/Off Control

The input-side, remote On/Off Control function can be ordered to operate with either logic type:

Positive ("P" suffix) logic models are enabled when the on/off pin is left open (or is pulled high, applying +10V to +15V with respect to -Input). Positive-logic devices are disabled when the on/off pin is pulled low (0 to 0.7V with respect to -Input).

Negative ("N" suffix) logic devices are off when pin is left open (or pulled high, applying +2.5V to +15V), and on when pin is pulled low (-0.1 to 0.8V) with respect to -Input as shown in Figure 4.

Dynamic control of the remote on/off function is best accomplished with a mechanical relay or an open-collector/open-drain drive circuit (optically isolated if appropriate). The drive circuit should be able to sink appropriate current (see Performance Specifications) when activated and withstand appropriate voltage when deactivated. Applying an external voltage to pin 2 when no input power is applied to the converter can cause permanent damage to the converter.

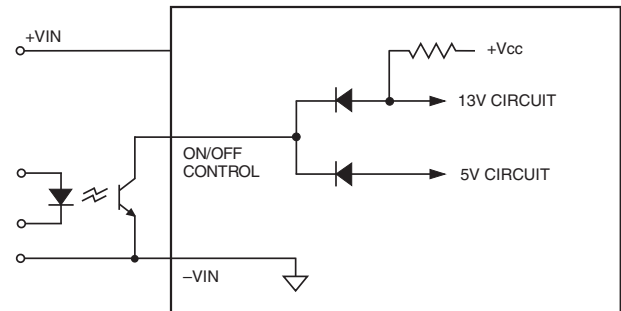

Figure 4. Driving the Negative Logic On/Off Control Pin (simplified circuit)

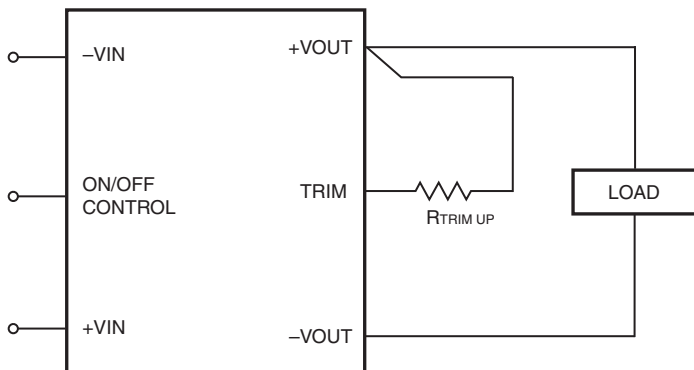

Figure 5. Trim Connections To Increase Output Voltages.
If units have sense pins, Connect trim to + Sense pin.

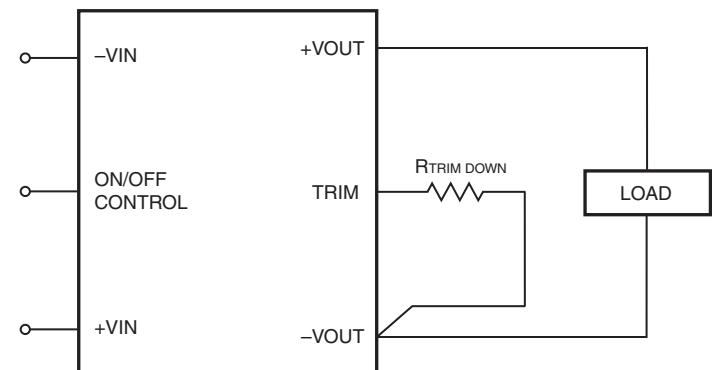

Figure 6. Trim Connections To Decrease Output Voltages.
If units have sense pins, connect Trim to (-) Sense pins.

Remote Sense (ULS-3.3/8-D48 and ULS-5/6-D48 models only)

Note: The Sense and V_{OUT} lines are internally connected through low-value resistors. Nevertheless, if the sense function is not used for remote regulation the user should connect the +Sense to +V_{OUT} and –Sense to –V_{OUT} at the DC/DC converter pins. ULS series converters employ a sense feature to provide point of use regulation, thereby overcoming moderate IR drops in PCB conductors or cabling. The remote sense lines carry very little current and therefore require minimal cross-sectional-area conductors. The sense lines, which are capacitively coupled to their respective output lines, are used by the feedback control-loop to regulate the output. As such, they are not low impedance points and must be treated with care in layouts and cabling. Sense lines on a PCB should be run adjacent to dc signals, preferably ground.

$$|V_{OUT(+)} - V_{OUT(-)} - [Sense(+)-Sense(-)] \leq 10\%V_{OUT}$$

In cables and discrete wiring applications, twisted pair or other techniques should be used. Output over-voltage protection is monitored at the output voltage pin, not the Sense pin. Therefore, excessive voltage differences between V_{OUT} and Sense in conjunction with trim adjustment of the output voltage can cause the over-voltage protection circuitry to activate (see Performance Specifications for over-voltage limits). Power derating is based on maximum output current and voltage at the converter’s output pins. Use of trim and sense functions can cause output voltages to increase, thereby increasing output power beyond the converter’s specified rating, or cause output voltages to climb into the output over-voltage region. Therefore, the designer must ensure:

$$(V_{OUT \text{ at pins}}) \times (I_{OUT}) \leq \text{rated output power}$$

Trim Equations

Trim Down

$$R_{T_DOWN} (k\Omega) = \frac{511}{\Delta\%} - 10.22$$

$$\text{Where } \Delta\% = \left| \left(\frac{V_{NOM} - V_{DES}}{V_{NOM}} \times 100 \right) \right|$$

Trim Up

$$R_{T_UP} (k\Omega) = \frac{5.11 \times V_{NOM} \times (100 + \Delta\%)}{1.225 \times \Delta\%} - \frac{511}{\Delta\%} - 10.22$$

Note: “Δ%” is always a positive value.
“V_{NOM}” is the nominal, rated output voltage.
“V_{DES}” is the desired, changed output voltage.

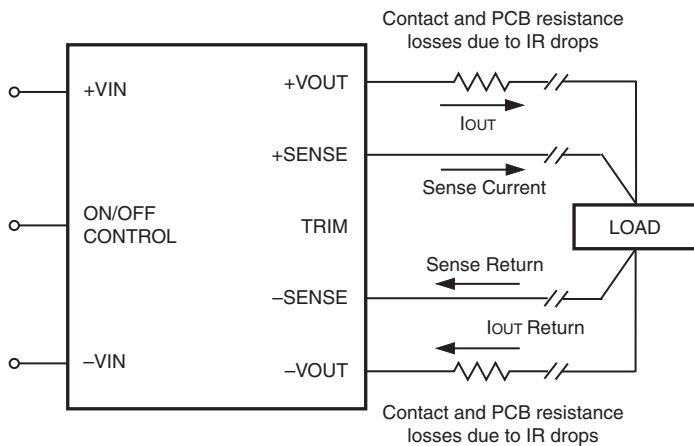

Figure 7. Remote Sense Circuit Configuration

Trimming by Using an External Voltage Source

1. The easiest way to trim the output using an external voltage source is to drive the Trim pin directly from a variable source. The following equation can be used to calculate the voltage at the Trim pin.

$$V_{trim} = 2 \times 1.24 \times \frac{V_o}{V_{nominal}} - 1.24$$

V_o is the output voltage you want; $V_{nominal}$ is the nominal output voltage; V_{trim} is the voltage that should appear at the trim pin.

2. If the purpose of trimming is to compensate voltage drop of power path from converter to the Load, you may separately connect the sense pin directly to the load. It's much easier than real time adjusting trim voltage.

3. CAUTION: To avoid unplanned power down cycles, do not exceed EITHER the maximum output voltage OR the maximum output power when setting the trim. If the output voltage is excessive, the OVP circuit may shut down the converter. If the maximum power is exceeded, the converter may enter current limiting. If the power is exceeded for an extended period, the converter may overheat and encounter overtemperature shut down. Be careful of external electrical noise. The Trim input is a sensitive input to the converter's feedback control loop. Excessive electrical noise may cause instability or oscillation.

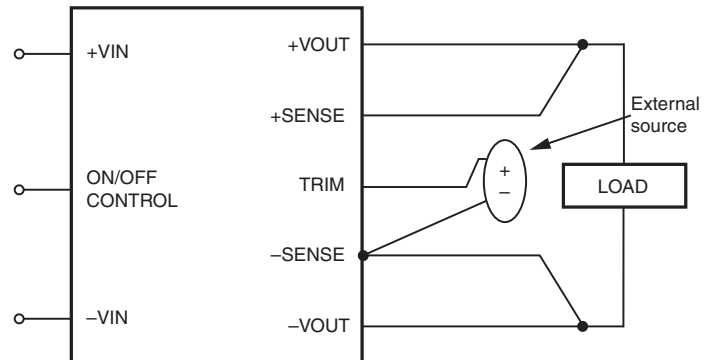

Figure 8. Trimming with an external source

Through-hole Soldering Guidelines

Murata Power Solutions recommends the TH soldering specifications below when installing these converters. These specifications vary depending on the solder type. Exceeding these specifications may cause damage to the product. Your production environment may differ; therefore please thoroughly review these guidelines with your process engineers.

Wave Solder Operations for through-hole mounted products (THMT)	
For Sn/Ag/Cu based solders:	
Maximum Preheat Temperature	115° C.
Maximum Pot Temperature	270° C.
Maximum Solder Dwell Time	7 seconds
For Sn/Pb based solders:	
Maximum Preheat Temperature	105° C.
Maximum Pot Temperature	250° C.
Maximum Solder Dwell Time	6 seconds

SMT Reflow Soldering Guidelines

The surface-mount reflow solder profile shown below is suitable for SAC305 type lead-free solders. This graph should be used only as a **guideline**. Many other factors influence the success of SMT reflow soldering. Since your production environment may differ, please thoroughly review these guidelines with your process engineers.

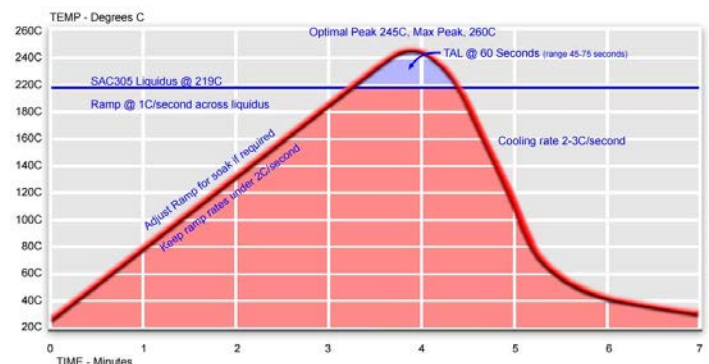

Emissions Performance

Murata Power Solutions measures its products for radio frequency emissions against the EN 55022 and CISPR 22 standards. Passive resistance loads are employed and the output is set to the maximum voltage. If you set up your own emissions testing, make sure the output load is rated at continuous power while doing the tests.

The recommended external input and output capacitors (if required) are included. Please refer to the fundamental switching frequency. All of this information is listed in the Product Specifications. An external discrete filter is installed and the circuit diagram is shown below.

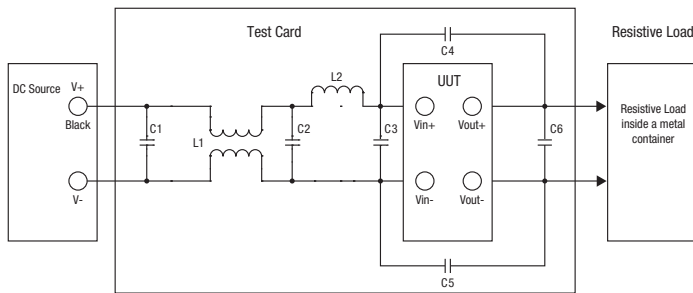

Figure 9. Conducted Emissions Test Circuit

[1] Conducted Emissions Parts List

Reference	Part Number	Description	Vendor
L1	PE-62913	1mH, 6A	Pulse
L2	NC	4.7uH, 3.6A	Murata
C1, C2	VZ Series	Ceramic Capacitor (3.2uf) = 2.2uf/1uf in parallel, 100V	Panasonic
C3	VZ Series	Qty 2 - Electrolytic Capacitor 22ufd, 100V	Panasonic
C4, C5	Unknown	3.3nF, 1500V	Unknown
C6	VZ Series	Electrolytic Capacitor 33ufd, 100V	Panasonic

[2] Conducted Emissions Test Equipment Used

- Rohde & Schwarz EMI Test Receiver (9KHz – 1000MHz) ESPC
- Rohde & Schwarz Software ESPC-1 Ver. 2.20
- HP11947A Transient Limiter (Agilent)
- OHMITE 25W – Resistor combinations
- DC Source Programmable DC Power Supply Model 62012P-100-50

[3] Layout Recommendations

Most applications can use the filtering which is already installed inside the converter or with the addition of the recommended external capacitors. For greater emissions suppression, consider additional filter components and/or shielding. Emissions performance will depend on the user's PC board layout, the chassis shielding environment and choice of external components. Please refer to Application Note GEAN-02 for further discussion.

Since many factors affect both the amplitude and spectra of emissions, we recommend using an engineer who is experienced at emissions suppression.

[4] Conducted Emissions Test Results

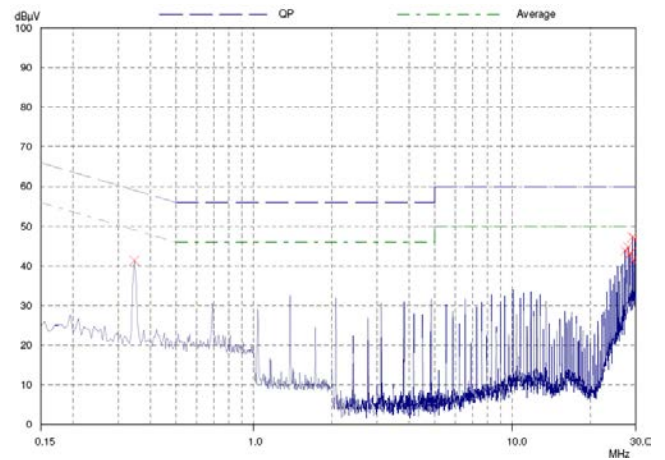

Graph 1. ULS-3.3/8-D48N-C conducted emissions performance, Peak Detection Mode, CISPR/EN55022, Class B, full load at 48Vin

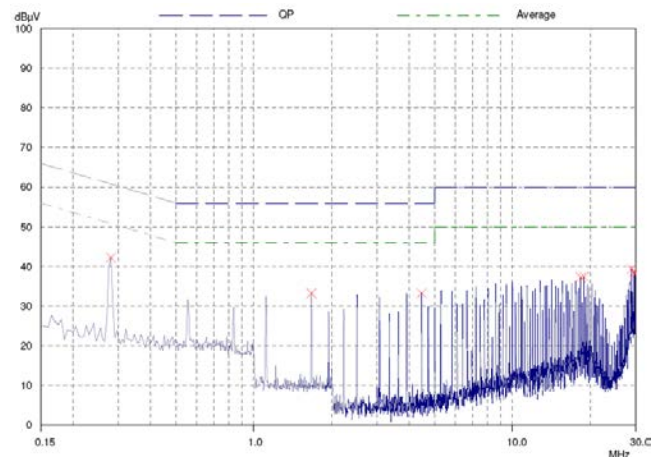

Graph 2. ULS-12/2.5-D48N-C conducted emissions performance, Peak Detection Mode, CISPR/EN55022, Class B, full load at 48Vin

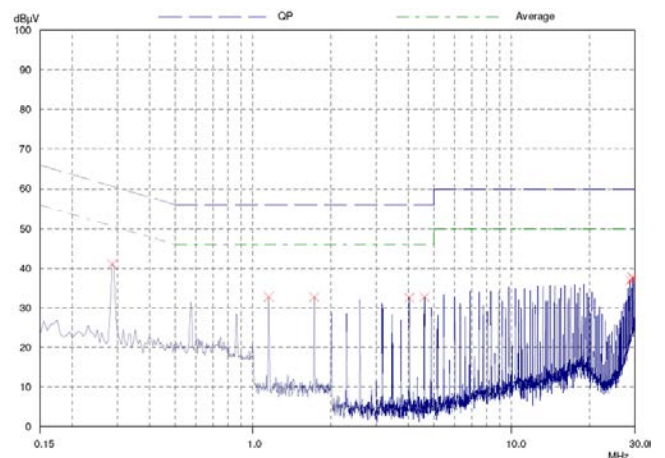

Graph 3. ULS-15/2-D48P-C conducted emissions performance, Peak Detection Mode, CISPR/EN55022, Class B, full load at 48Vin

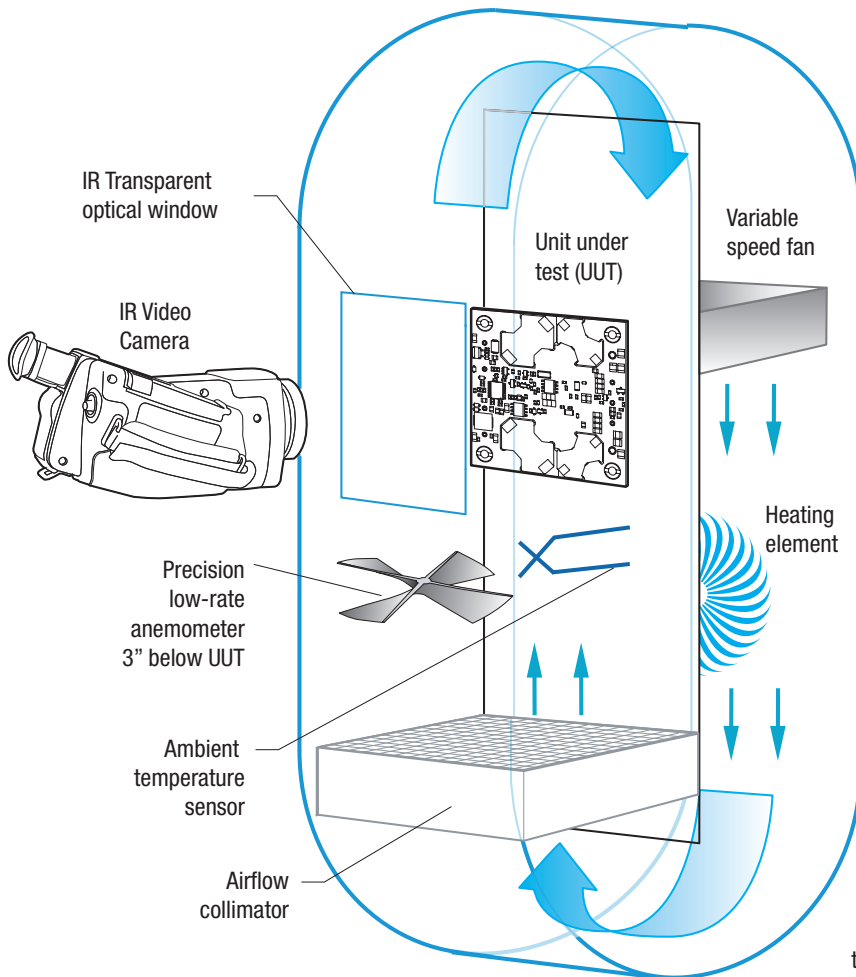

Figure 10. Vertical Wind Tunnel

Vertical Wind Tunnel

Murata Power Solutions employs a computer controlled custom-designed closed loop vertical wind tunnel, infrared video camera system, and test instrumentation for accurate airflow and heat dissipation analysis of power products. The system includes a precision low flow-rate anemometer, variable speed fan, power supply input and load controls, temperature gauges, and adjustable heating element.

The IR camera monitors the thermal performance of the Unit Under Test (UUT) under static steady-state conditions. A special optical port is used which is transparent to infrared wavelengths.

Both through-hole and surface mount converters are soldered down to a host carrier board for realistic heat absorption and spreading. Both longitudinal and transverse airflow studies are possible by rotation of this carrier board since there are often significant differences in the heat dissipation in the two airflow directions. The combination of adjustable airflow, adjustable ambient heat, and adjustable Input/Output currents and voltages mean that a very wide range of measurement conditions can be studied.

The collimator reduces the amount of turbulence adjacent to the UUT by minimizing airflow turbulence. Such turbulence influences the effective heat transfer characteristics and gives false readings. Excess turbulence removes more heat from some surfaces and less heat from others, possibly causing uneven overheating.

Both sides of the UUT are studied since there are different thermal gradients on each side. The adjustable heating element and fan, built-in temperature gauges, and no-contact IR camera mean that power supplies are tested in real-world conditions.

